



PURITY PUMP CO., LTD. reserves the right to make changes without notice. all the specifications may be subject to change

60HZ

+86 400 - 881 - 4188

puritypump@cnpurity.com

Dongqiao Village, Daxi Town, Wenling City, Zhejiang, China



<https://www.cnpurity.com>

2024. 03



**General Catalogue**  
**Catálogo General**  
**Catalogue général**

[www.cnpurity.com](http://www.cnpurity.com)

# COMPANY PROFILE

Purity was established in 2010. At the beginning of its establishment, it had high ambitions. It took energy-saving industrial pumps as its strategic positioning, quality and service as its core competitiveness, and deeply cultivated the field of energy-saving industrial pumps.

Purity Pump Industry focuses on the research and development of pump energy-saving technology, and cooperates with European professional teams and domestic Shanghai and Shenzhen energy-saving technology cutting-edge scientific research institutions. The energy-saving layout is deeply integrated in the fields of municipal administration, agriculture, chemical industry, metallurgy, textile, cooling, etc., aiming to reduce emissions and generate income for all walks of life, continuously implement environmental protection awareness, help efficient use of resources, and promote sustainable development of enterprises.

In-depth research and development and exploration, Purity has continuously improved and surpassed itself, participated in the drafting of national standards for centrifugal pumps, intelligent variable frequency circulating electric pumps, and vertical pipeline pumps, and has successively won the "National Hightech Enterprise" Provincial Science and Technology Enterprise", "Provincial Specialized Special New Enterprise" and other honors.

**300<sup>+</sup>**

Domestic And Foreign  
Dealer Network

**200<sup>+</sup>**

Product Category

**125<sup>+</sup>**

Patent Certification



# CONTENTS

reliable pumps for project

**PST/PST4** Close coupled centrifugal pump  
**PST/PST4** Bomba centrifuga acoplado cerrado  
**PST/PST4** Pompe centrifuge à couple fermé ..... 1

**PS/PS4** End suction centrifugal pump  
**PS/PS4** Bomba centrifuga de succión final  
**PS/PS4** Pompe centrifuge aspiration finale ..... 11

**YE3** Electric motor TEFC type  
**YE3** Motor eléctrico tipo TEFC  
**YE3** Moteur électrique type TEFC ..... 21

**PD** Diesel engine for pump  
**PD** Motor diesel para bomba  
**PD** Moteur diesel pour pompe ..... 25

**PV** Vertical multistage centrifugal pump  
**PV** Bomba centrifuga multietapa vertical  
**PV** Pompe centrifuge multicellulaire verticale ..... 27

**PVT/PVS** Stainless steel 304 vertical multistage pump  
**PVT/PVS** Bomba de etapas múltiples inox304  
**PVT/PVS** Pompe multicellulaire verticale inox304 ..... 31

**PEDJ/PEJ/PDJ/PVK** Fire fighting system  
**PEDJ/PEJ/PDJ/PVK** Sistema de contra incendio  
**PEDJ/PEJ/PDJ/PVK** Système anti-incendie ..... 39

**PTD** Inline circulation pump  
**PTD** Bomba de circulación en línea  
**PTD** Pompe de circulation en ligne ..... 57

**PW** Same port centrifugal pump  
**PW** Bomba centrifuga misma puerto  
**PW** Pompe centrifuge même port ..... 63

**PC/P2C** Thread port centrifugal pump  
**PC/P2C** Bomba centrifuga roscada  
**PC/P2C** Pompe centrifuge à orifice fileté ..... 67

**PZ** Stainless steel standard pump  
**PZ** Bomba normalizada en acero inoxidable  
**PZ** Pompe standard en acier inoxydable ..... 75

**PT** Vertical inline pump  
**PT** Bomba vertical en-línea  
**PT** Pompe en ligne verticale ..... 81

**PG** Single suction centrifugal pump  
**PG** Bomba centrifuga de succión simple  
**PG** Pompe centrifuge à aspiration unique ..... 87

**PSC** Double suction split case pump  
**PSC** Succión doble bomba de cámara partida  
**PSC** Pompe à double corps d'aspiration ..... 95

**PXZ** Self-priming centrifugal pump  
**PXZ** Bomba centrifuga autocebante  
**PXZ** Pompe centrifuge auto-amorçante ..... 101

**PZW** Self-priming non-blocking sewage pump  
**PZW** Bomba de aguas residuales autocebante  
**PZW** Pompe d'égout autobloquante non bloquante ..... 103

**WQV** Vortex cutting submersible pump  
**WQV** Vórtice bomba sumergible de corte  
**WQV** Pompe submersible de coupe Vortex ..... 105

**WQ** Submersible sewage pump  
**WQ** Bomba sumergible para aguas sucias  
**WQ** Pompe submersible pour eaux usées ..... 113

**XBD** Turbine Fire Pump  
**XBD** Bomba de incendio en una turbina  
**XBD** Pompe à incendie à turbine ..... 123

**PBWS** Non-negative pressure water supply system  
**PBWS** Sistema de suministro presión no negativa  
**PBWS** Système d'alimentation à pression non négative ..... 133

**PERFORMANCE CURVE/CURVA/COURBE** ..... 137



## PST

Close coupled centrifugal pump  
 Bomba centrífuga acoplado cerrado  
 Pompe centrifuge à couple fermé



PST



PST(B)



PST(C)

 PST/B/C  
 30-160kW

### NEW/NUEVO/NOUVEAU

#### DESCRIPTION/DESCRIPCIONES/DESCRIPTION

- New EN733 standard centrifugal pump
  - Original design by PURITY (Patent no.201530478502.0)
  - Both square motor & round motor available
  - YE3 high efficient motor, with protection IP55 class F
  - Pump case with anti-corrosive coating
  - Galvanized counter flange with bolts, nuts and gaskets
  - Quality NSK bearing, wear resistance mechanical seal
- Nuevas bombas centrifugas según norma EN733
  - Diseño original de PURITY (Patente no.201530478502.0)
  - Motor redondo y cuadrado disponible
  - Motor de eficiencia YE3 con Protección IP55 clase F
  - Cuerpo de bomba con tratamiento anti-corrosión
  - Contrabridas galvanizadas con pernos, tuercas y empaques
  - Rodamiento de marca NSK y cierre mecánico personalizado
- Nouvelle pompe centrifuge standard EN733
  - Design original par PURITY (Brevet no.201530478502.0)
  - Moteur carré et moteur rond disponibles
  - Moteur haute efficacité YE3, avec protection IP55 classe F
  - Boîtier de pompe avec revêtement anti-corrosif
  - Contre-bride galvanisée avec boulons, écrous et joints
  - Roulement NSK qualité, joint mécanique de résistance à l'usure

### APPLICATIONS/APLICACIONES/APPLICATIONS

- Suitable for use with clean water and liquids that are not chemically aggressive towards the materials from which the pump is made. The EN733 centrifugal pumps are recommended for use in water supply, cleaning sets, pressure boosting, firefighting sets, irrigation, industrial applications, water circulation in climatisation sets, agricultural.
- Son recomendadas para bombear agua limpia, sin partículas abrasivas y líquidos químicamente no agresivos con los materiales que constituyen la bomba. Las Bombas centrífugas según EN733 diseñadas para abastecimiento hídrico, instalaciones de lavado, presurización, contra incendio, irrigación, industria, circulación del agua, agricultura.
- Convient pour une utilisation avec de l'eau propre et des liquides qui ne sont pas chimiquement agressif envers les matériaux dont la pompe est faite. Les pompes centrifuges EN733 sont recommandées pour une utilisation dans l'alimentation en eau, kits de nettoyage, boosters de pression, kits anti-incendie, irrigation, industriels applications, circulation de l'eau dans les groupes de climatisation, agricole.

### USING LIMITS/LÍMITES UTILIZACIÓN/UTILISATION LIMITES

- Liquid temperature between **-10°C** and **+120°C**
  - Ambient temperature between **-10°C** and **+50°C**
  - Max. working pressure **16 bar**
  - Continuous service **S1**
- Temperatura del líquido de **-10 °C** hasta **+120 °C**
  - Temperatura ambiente de **-10 °C** hasta **+50 °C**
  - Presión máxima en el cuerpo de la bomba **16 bar**
  - Funcionamiento continuo **S1**
- Température du liquide entre **-10 °C** et **+120 °C**
  - Température ambiante entre **-10 °C** et **+50 °C**
  - Max. pression de service **16 bar**
  - Service continu **S1**

### MODEL CODE/CÓDIGO MODELO/CODE MODÈLE

For example/Par ejemplo/Par exemple

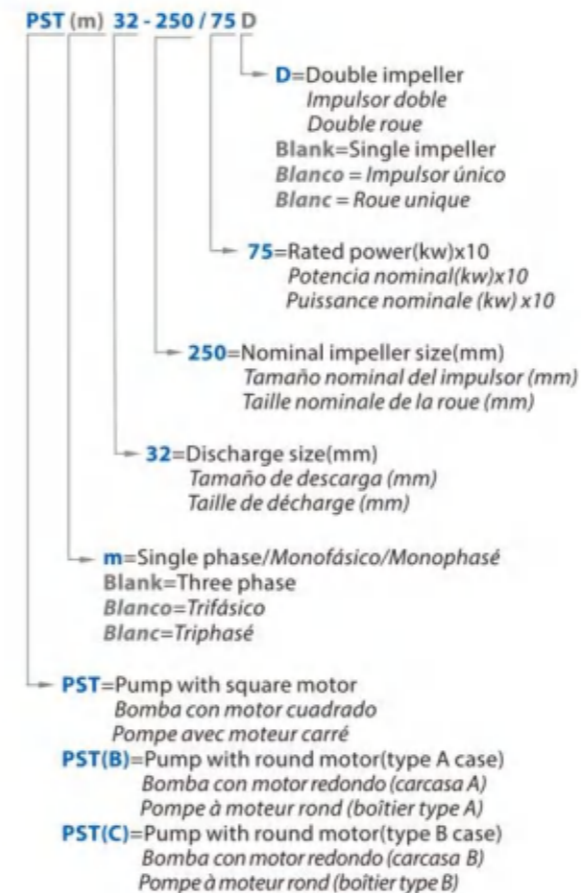

### TECHNICAL SHEET/HOJA TÉCNICA/FICHE TECHNIQUE

Model/Modelo/Modèle	PST	
Capacity/Caudal/Débit	0-400	m <sup>3</sup> /h
Head/Altura/Hauteur	0-151	m
DN	32-125	mm
Speed/Velocidad/Vitesse	3500	rpm
T max	120	°C
Power/Potencia/Puiss.	0.75-160	kW
Voltage/Voltaje/Tension	220/380/400/440 V	
HZ	60	
Class/Clase/Classe	Class F	
IP	IP 55	
Duty/Servicio/Devoir	S1 continuous	
Casing/Cuerpo/Corps	Grey Cast iron Hierro fundido gris Fonte grise	
Impeller/Impulsor/Roue	Cast iron/AISI 304/Brass Hierro fundido/Inox304/Bronce Fonte/Inox304/Laiton	
Shaft/Eje/Arbre	45# steel/AISI304 45 # acero/Inox304 45 # acier/Inox304	
Shaft seal/Sello/Scellé	Mechanical Seal Sello mecánico Garniture mécanique	
Bearing/Rodamiento/Palier	Grease lubrication rolling bearing Rodamientos lubricación con grasa Roulement lubrification à la graisse	

60Hz n=3500 r/min

MODEL MODELO MODÈLE	DN mm	Power Potencia Puissance		Q=DELIVERY/CAUDAL/DÉBIT																				
		kw	hp	us gpm	0	26	40	66	79	106	119	159	185	211	238	317	370	396	476	529	608			
				L/min	100	150	250	300	400	450	600	700	800	900	1200	1400	1500	1800	2000	2300				
				m³/h	6	9	15	18	24	27	36	42	48	54	72	84	90	108	120	138				
				H=Head/Altura/Hauteur(m)																				
PST 32-125/07	50x32	0.75	1	17.5	16.7	15	12	9	-	-	-	-	-	-	-	-	-	-	-	-	-	-		
PST 32-125/11	50x32	1.1	1.5	22	21	19.7	16.5	14.5	9	-	-	-	-	-	-	-	-	-	-	-	-	-		
PST 32-160/15	50x32	1.5	2	25.4	23.7	22.5	18.5	15.8	-	-	-	-	-	-	-	-	-	-	-	-	-	-		
PST 32-160/22	50x32	2.2	3	31	29.6	28.5	24.5	22	15	-	-	-	-	-	-	-	-	-	-	-	-	-		
PST 32-160/30	50x32	3	4	35	34.3	32.5	28	25.5	19	15	-	-	-	-	-	-	-	-	-	-	-	-		
PST 32-200/30	50x32	3	4	44.2	42	39.8	35.2	32.2	24.6	19.8	-	-	-	-	-	-	-	-	-	-	-	-		
PST 32-200/40	50x32	4	5.5	54.5	52	50	45.5	42.3	35	30.3	-	-	-	-	-	-	-	-	-	-	-	-		
PST 32-250/55	50x32	5.5	7.5	60	59.5	59	55	50.2	34.5	-	-	-	-	-	-	-	-	-	-	-	-	-		
PST 32-250/75	50x32	7.5	10	69.5	69	68.5	66	63	53	-	-	-	-	-	-	-	-	-	-	-	-	-		
PST 32-250/92	50x32	9.2	12.5	75	75	74.5	72	69	59	-	-	-	-	-	-	-	-	-	-	-	-	-		
PST 32-250/110	50x32	11	15	90	89.5	88	82	78	66	-	-	-	-	-	-	-	-	-	-	-	-	-		
PST 32-250/150	50x32	15	20	97	96.5	96	90	86	73	-	-	-	-	-	-	-	-	-	-	-	-	-		
PST 32-250/55D	50x32	5.5	7.5	79.5	74.7	71.8	63	56	37.5	-	-	-	-	-	-	-	-	-	-	-	-	-		
PST 32-250/75D	50x32	7.5	10	95	93	91	83	76	57.8	-	-	-	-	-	-	-	-	-	-	-	-	-		
PST 40-125/11	65x40	1.1	1.5	14.7	-	-	-	13	11.5	10.1	5.8	-	-	-	-	-	-	-	-	-	-	-		
PST 40-125/15	65x40	1.5	2	18.1	-	-	-	17	15	13.9	10	6	-	-	-	-	-	-	-	-	-	-		
PST 40-125/22	65x40	2.2	3	24.5	-	-	-	23.2	21.5	20.2	16	13	8.3	-	-	-	-	-	-	-	-	-		
PST 40-160/30	65x40	3	4	31.8	-	-	-	29.5	27.5	26.3	21.5	17.5	-	-	-	-	-	-	-	-	-	-		
PST 40-160/40	65x40	4	5.5	38	-	-	-	36	34	33	28.5	25	20.1	-	-	-	-	-	-	-	-	-		
PST 40-200/55	65x40	5.5	7.5	46	-	-	-	43.8	41.3	40.1	35	30	-	-	-	-	-	-	-	-	-	-		
PST 40-200/75	65x40	7.5	10	57	-	-	-	53.6	51.5	50	45	41	36.5	-	-	-	-	-	-	-	-	-		
PST 40-250/92	65x40	9.2	12.5	64	-	-	-	59	56.5	55	49.5	45	39.8	-	-	-	-	-	-	-	-	-		
PST 40-250/110	65x40	11	15	72	-	-	-	67.5	65	63.5	57.5	52.2	47	-	-	-	-	-	-	-	-	-		
PST 40-250/150	65x40	15	20	84.5	-	-	-	79.3	77.3	75.2	70	66	61	-	-	-	-	-	-	-	-	-		
PST 40-250/185	65x40	18.5	25	90	-	-	-	85.5	82.8	80.7	75.8	70.5	66.5	-	-	-	-	-	-	-	-	-		
PST 50-125/22	65x50	2.2	3	17	-	-	-	-	-	15.4	14	12.8	11.5	6.5	-	-	-	-	-	-	-	-		
PST 50-125/30	65x50	3	4	20	-	-	-	-	-	18.8	18	17	15.6	11	-	-	-	-	-	-	-	-		
PST 50-125/40	65x50	4	5.5	24	-	-	-	-	-	23.1	23	21.5	20.3	15.8	11.8	-	-	-	-	-	-	-		
PST 50-160/55	65x50	5.5	7.5	32	-	-	-	-	-	30.6	30	28	26.6	20.5	14.8	-	-	-	-	-	-	-		
PST 50-160/75	65x50	7.5	10	40	-	-	-	-	-	38	37	36	34.4	29	24	21	-	-	-	-	-	-		
PST 50-200/92	65x50	9.2	12.5	50.5	-	-	-	-	-	46.8	45	43	40.9	32.5	26.7	-	-	-	-	-	-	-		
PST 50-200/110	65x50	11	15	57.5	-	-	-	-	-	53.5	52	50	47.5	40	34	29	-	-	-	-	-	-		
PST 50-200/150	65x50	15	20	62	-	-	-	-	-	58	56.5	54.5	52	44.5	39	35.5	-	-	-	-	-	-		
PST 50-250/150	65x50	15	20	68.5	-	-	-	-	-	64	63	61.5	59	50	41	-	-	-	-	-	-	-		
PST 50-250/185	65x50	18.5	25	79	-	-	-	-	-	75.8	74.8	74	71.5	63.5	55.5	47	-	-	-	-	-	-		
PST 50-250/220	65x50	22	30	89.5	-	-	-	-	-	86	85.3	84	81.5	73.5	63.5	57	-	-	-	-	-	-		
PST 65-125/40	80x65	4	5.5	19	-	-	-	-	-	-	-	17.3	16.8	14.5	13	11.8	-	-	-	-	-	-		
PST 65-125/55	80x65	5.5	7.5	23	-	-	-	-	-	-	-	21.3	20.9	19	17.5	16.7	13.7	-	-	-	-	-		
PST 65-125/75	80x65	7.5	10	27	-	-	-	-	-	-	-	26	25.6	24.5	23	22.5	20	18	-	-	-	-		
PST 65-160/92	80x65	9.2	12.5	33	-	-	-	-	-	-	-	31.5	30	28	27.1	24	21.5	-	-	-	-	-		
PST 65-160/110	80x65	11	15	36	-	-	-	-	-	-	-	34.5	33	31.5	30.8	28	25.5	-	-	-	-	-		
PST 65-160/150	80x65	15	20	42	-	-	-	-	-	-	-	41	40	38.5	37.8	35	33	29.5	-	-	-	-		
PST 65-200/150	80x65	15	20	45	-	-	-	-	-	-	-	45.5	43	41	40.2	36.5	34	-	-	-	-	-		
PST 65-200/185	80x65	18.5	25	52	-	-	-	-	-	-	-	52.3	51	49	48.2	44.5	42	-	-	-	-	-		
PST 65-200/220	80x65	22	30	59	-	-	-	-	-	-	-	59.5	58	56	55	52	49.5	44.5	-	-	-	-		
PST 65-250/220	80x65	22	30	64.8	-	-	-	-	-	-	-	64.7	62	60	58.5	53	50	-	-	-	-	-		
PST 65-250/300	80x65	30	40	80	-	-	-	-	-	-	-	79.8	77.5	75.5	74.5	70	66	58	-	-	-	-		
PST 65-250/370	80x65	37	50	92	-	-	-	-	-	-	-	90.5	88.5	87	85	80.5	78	68	-	-	-	-		

PSTB PSTC also available/también disponible/aussi disponible

Performance curve in page/Curva en página/Courbe en page 141-145

60Hz n=3500 r/min

MODEL MODELO MODÈLE	DN mm	Power Potencia Puissance		Q=DELIVERY/CAUDAL/DÉBIT																		
		kw	hp	us gpm	0	264	396	529	634	793	881	925	969	1057	1233	1322	1586	1762				
				L/min	1000	1500	2000	2400	3000	3333	3500	3667	4000	4667	5000	6000	6667					
				m³/h	60	90	120	144	180	200	210	220	240	280	300	360	400					
				H=Head/Altura/Hauteur(m)																		
PST 65-315/450	80x65	45	60	102	98	94.5	90	83	-	-	-	-	-	-	-	-	-	-	-	-	-	-
PST 65-315/550	80x65	55	75	122	120	114.5	110	100	76	-	-	-	-	-	-	-	-	-	-	-	-	-
PST 65-315/750	80x65	75	100	141	141	134.5	130	120	96	78	65.5	-	-	-	-	-	-	-	-	-	-	-
PST 65-315/900	80x65	90	125	151	150	144.5	140	130	106	88	75.5	-	-	-	-	-	-	-	-	-	-	-
PST 80-125/40	100x80	4	5.5	17	15	12.3	7.5	-	-	-	-	-	-	-	-	-	-	-	-	-	-	-
PST 80-125/55	100x80	5.5	7.5	21	19.6	17.4	13.4	9.5	-	-	-	-	-	-	-	-	-	-	-	-	-	-
PST 80-125/75	100x80	7.5	10	26	24.8	23	19.5	16.5	-	-	-	-	-	-	-	-	-	-	-	-	-	-
PST 80-160/110	100x80	11	15	28	27	27.3	24.5	21.1	16	-	-	-	-	-	-	-	-	-	-	-	-	-
PST 80-160/150	100x80	15	20	34	32.6	32.5	30.2	27	22.1	18.5	16.7	-	-	-	-	-	-	-	-	-	-	-
PST 80-160/185	100x80	18.5	25	39	38.5	38	36.7	33.6	28.8	25.3	23.5	-	-	-	-	-	-	-	-	-	-	-
PST 80-160/220	100x80	22	30	44	43.5	43	41.7	38.6	33.8	30.3	28.5	-	-	-	-	-	-	-	-	-	-	-
PST 80-200/220	100x80	22	30	48	47.7	47.5	43.5	39.2	32.5	27.2	24.5	-	-	-	-	-	-	-	-	-	-	-
PST 80-200/300	100x80	30	40	60	59.7	59.5	57	53.1	47	42.7	40.5	-	-	-	-	-	-	-	-	-	-	-
PST 80-250/370	100x80	37	50	71.5	70.9	70.5	65.5	59.3	51	43.2	38.5	-	-	-	-	-	-	-	-	-	-	-
PST 80-250/450	100x80	45	60	88	86.7	86	83.6	78.5	70.5	60	51	-	-	-	-	-	-	-	-	-	-	-
PST 80-250/550	100x80	55	75	94.5	94.5	94.5	91.8	87	79.5	72.1	68.3	-	-	-	-	-	-	-	-	-	-	-
PST 80-315/450	100x80	45	60	85	84	82.6	82	78	68.3	61	56	-	-	-	-	-	-	-	-	-	-	-
PST 80-315/550	100x80	55	75	98	97	95.6	95	91	81.3	74	69	-	-	-	-	-	-	-	-	-	-	-
PST 80-315/750	100x80	75	100	124	123	121.6	121	117</														



## PST4 n=1750 r/min

Close coupled centrifugal pump  
 Bomba centrífuga acoplado cerrado  
 Pompe centrifuge à couple fermé



60Hz n=1750 r/min

MODEL MODELO MODÈLE	DN mm	Power Potencia Puissance kw hp	Q=DELIVERY/CAUDAL/DÉBIT																
			us gpm		0	198	220	264	317	370	396	423	476	617	661	881	1101		
			l/min	750	833	1000	1200	1400	1500	1667	1833	2000	2333	2500	3333	4167	5000	6667	8333
			m <sup>3</sup> /h	45	50	60	72	84	90	96	108	140	150	200	250				
			H=Head/Altura/Hauteur(m)																
PST4 80-315/55	100x80	5.5 7.5	19.7	19.1	18.8	18.1	16.8	15	13.9	12.8	10.1	-	-	-	-	-	-	-	-
PST4 80-315/75	100x80	7.5 10	24.6	23.9	23.6	23	21.9	20.4	19.5	18.6	16.3	-	-	-	-	-	-	-	-
PST4 80-315/110	100x80	11 15	29.9	29.4	29.2	28.8	28.1	27	26.3	25.5	23.6	16.5	13.5	-	-	-	-	-	-
PST4 80-315/150	100x80	15 20	36.8	36.4	36.1	35.6	34.7	33.6	33	32.4	30.9	25.3	23	-	-	-	-	-	-
PST4 80-400/185	100x80	18.5 25	40.3	39.7	39.5	39.1	38.4	37.3	36.6	35.9	34.1	27.3	24.5	-	-	-	-	-	-
PST4 80-400/220	100x80	22 30	45.1	44.6	44.5	44.2	43.6	42.6	42	41.4	39.8	33.4	30.7	-	-	-	-	-	-
PST4 80-400/300	100x80	30 40	55.1	54.7	54.6	54.4	54	53.3	52.8	52.2	50.9	45.4	43.2	-	-	-	-	-	-
PST4 100-200/40	125x100	4 5.5	11.8	11.7	11.6	11.4	11	10.5	10.3	9.7	9.1	6.8	5.9	-	-	-	-	-	-
PST4 100-200/55	125x100	5.5 7.5	13.3	13.2	13.2	13	12.7	12.4	12.3	12	11.5	9.6	8.8	5.7	-	-	-	-	-
PST4 100-200/75	125x100	7.5 10	14.8	14.7	14.7	14.5	14.2	13.9	13.8	13.5	13	11.1	10.3	7.2	-	-	-	-	-
PST4 100-250/55	125x100	5.5 7.5	15.9	15.8	15.7	15.5	14.9	14.4	14.1	13.4	12.5	9.2	7.9	-	-	-	-	-	-
PST4 100-250/75	125x100	7.5 10	19.5	19.5	19.4	19.2	18.8	18.3	18.1	17.6	16.9	14	12.7	-	-	-	-	-	-
PST4 100-250/110	125x100	11 15	24.3	24.3	24.2	24.1	23.7	23.3	23.1	22.7	22.1	19.7	18.6	11.4	-	-	-	-	-
PST4 100-250/150	125x100	15 20	27.8	27.8	27.7	27.6	27.2	26.8	26.6	26.2	25.6	23.2	22.1	14.9	-	-	-	-	-
PST4 100-315/150	125x100	15 20	28	-	27.8	27.6	27.2	26.9	26.7	26.2	25.6	23.1	22.1	14.9	-	-	-	-	-
PST4 100-315/185	125x100	18.5 25	31	-	30.8	30.6	30.2	29.9	29.7	29.2	28.6	26.1	25.1	17.9	-	-	-	-	-
PST4 100-315/220	125x100	22 30	35	-	34.4	34.2	33.8	33.5	33.3	32.8	32.2	30	29	24	17.3	-	-	-	-
PST4 100-315/300	125x100	30 40	37	-	36.8	36.7	36.4	36.1	35.9	35.5	35.1	33.2	32.4	28	21.3	-	-	-	-
PST4 100-400/300	125x100	30 40	46.4	-	-	46	46	46	46	46	45	44	42	40	29.6	-	-	-	-
PST4 100-400/370	125x100	37 50	51.8	-	-	51.3	51.2	51.1	51	50.5	49.5	47.5	46	37.3	-	-	-	-	-
PST4 100-400/450	125x100	45 60	57.1	-	-	56.7	56.4	56.1	56	56	55	53	52	45	32.1	-	-	-	-

MODEL CODE/CÓDIGO MODELO/CODE MODÈLE

For example/Par ejemplo/Par exemple

**PST4 100 - 250 / 75**

- 75=Rated power(kw)x10  
Potencia nominal(kw)x10  
Puissance nominale (kw) x10
- 250=Nominal impeller size(mm)  
Tamaño nominal del impulsor (mm)  
Taille nominale de la roue (mm)
- 100=Discharge/Descarga/Décharge(mm)
- PST4=Pump with 4 poles motor  
Bomba con motor de 4 polos  
Pompe avec moteur 4 pôles

TECHNICAL SHEET/HOJA TÉCNICA/FICHE TECHNIQUE

Model/Modelo/Modèle	PST4	
Capacity/Caudal/Débit	0-600	m <sup>3</sup> /h
Head/Altura/Hauteur	0-72	m
DN	65-150	mm
Speed/Velocidad/Vitesse	1750	rpm
Power/Potencia/Puiss.	3-132	kW

TECHNICAL DATA/DATOS TÉCNICOS/DONNÉES TECHNIQUES

60Hz n=1750 r/min

MODEL MODELO MODÈLE	DN mm	Power Potencia Puissance kw hp	Q=DELIVERY/CAUDAL/DÉBIT																
			us gpm		0	132	159	185	198	220	264	317	370	396	423	476	617		
			l/min	500	600	700	750	833	1000	1200	1400	1500	1600	1800	2333	3000	3667	4500	5667
			m <sup>3</sup> /h	30	36	42	45	50	60	72	84	90	96	108	140				
			H=Head/Altura/Hauteur(m)																
PST4 65-250/30	80x65	3 4	15.4	14.6	13.9	13.1	12.6	11.6	9.7	6.7	-	-	-	-	-	-	-	-	-
PST4 65-250/40	80x65	4 5.5	19	18.3	17.8	17.2	16.9	16.1	14.4	11.7	-	-	-	-	-	-	-	-	-
PST4 65-250/55	80x65	5.5 7.5	22.3	21.3	20.9	20.3	19.9	19.2	17.7	15.1	12	-	-	-	-	-	-	-	-
PST4 65-315/40	80x65	4 5.5	18.6	17.9	17.3	16.7	16.2	15.2	13.3	-	-	-	-	-	-	-	-	-	-
PST4 65-315/55	80x65	5.5 7.5	22.1	-	21.2	20.6	20.2	19.2	17.3	14	-	-	-	-	-	-	-	-	-
PST4 65-315/75	80x65	7.5 10	26.5	-	25.6	25.2	24.9	24.3	23	20.8	17.6	-	-	-	-	-	-	-	-
PST4 65-315/110	80x65	11 15	34.8	-	34.2	33.9	33.7	33.2	32.1	30.2	27.4	25.6	23.7	18.7	-	-	-	-	-
PST4 65-315/150	80x65	15 20	40	-	39.4	39.1	38.9	38.4	37.3	35.4	32.6	30.8	28.9	23.9	-	-	-	-	-
PST4 80-200/30	100x80	3 4	11.8	-	-	-	11	10.7	10.1	9.2	8	7.3	6.6	-	-	-	-	-	-
PST4 80-200/40	100x80	4 5.5	14.2	-	-	-	13.8	13.6	13.3	12.4	11.3	10.7	10	9	-	-	-	-	-
PST4 80-250/55	100x80	5.5 7.5	20.5	-	-	-	19.5	19.1	18.4	17.2	15.5	14.5	13.5	11.1	-	-	-	-	-
PST4 80-250/75	100x80	7.5 10	24	-	-	-	23.5	23.2	22.5	21.3	19.9	19	18.1	16	-	-	-	-	-
PST4 80-250/110	100x80	11 15	28.2	-	-	-	27.5	27.2	26.5	25.3	23.9	23	22.1	20	15	-	-	-	-

Performance curve in page/Curva en página/Courbe en page 144-147

MODEL MODELO MODÈLE	DN mm	Power Potencia Puissance kw hp	Q=DELIVERY/CAUDAL/DÉBIT																				
			us gpm		0	132	154	176	220	264	396	441	485	617	661	881	1101	1322	1762	2203	2643		
			l/min	500	583	667	833	1000	1500	1667	1833	2333	2500	3333	4167	5000	6667	8333	10000				
			m <sup>3</sup> /h	30	35	40	50	60	90	100	110	140	150	200	250	300	400	500	600				
			H=Head/Altura/Hauteur(m)																				
PST4 125-200/55	150x125	5.5 7.5	11.4	11.1	11.1	11	10.9	10.8	10.2	10	9.7	8.9	8.6	6.9	-	-	-	-	-	-	-	-	-
PST4 125-200/75	150x125	7.5 10	14.1	13.9	13.8	13.8	13.7	13.6	13.1	12.9	12.7	11.9	11.6	9.6	-	-	-	-	-	-	-	-	-
PST4 125-200/110	150x125	11 15	18.1	17.9	17.8	17.8	17.7	17.6	17.1	16.9	16.7	15.9	15.6	13.6	9.8	-	-	-	-	-	-	-	-
PST4 125-250/75	150x125	7.5 10	15.4	-	-	-	-	15.3	15	14.8	14.6	13.6	13.1	-	-	-	-	-	-	-	-	-	-
PST4 125-250/110	150x125	11 15	19.4	-	-	-	-	19.3	19.1	19	18.9	18.1	17.8	15.3	11.7	-	-	-	-	-	-	-	-
PST4 125-250/150	150x125	15 20	23.2	-	-	-	-	23.3	23.1	23	22.9	22	22	19.8	16.5	12.3	-	-	-	-	-	-	-
PST4 125-250/185	150x125	18.5 25	25.6	-	-	-	-	25.5	25.5	25.4	25.3	24.9	24.7	23	20.3	16.5	-	-	-	-	-	-	-
PST4 125-315/185	150x125	18.5 25	27.3	-	-	-	-	-	-	26.9	26.7	25.9	25.6	23.3	19.7	14.9	-	-	-	-	-	-	-
PST4 125-315/220	150x125	22 30	30	-	-	-	-	-	-	29.7	29.6	28.9	28.6	26.5	23.2	18.4	-	-	-	-	-	-	-
PST4 125-315/300	150x125	30 40	35.6	-	-	-	-	-	-	35.4	35.3	34.8	34.6	32.9	30.1	26.1	-	-	-	-	-	-	-
PST4 125-315/370	150x125	37 50	38.2	-	-	-	-	-	-	38	37.9	37.4	37.2	35.7	33.1	29.4	17.8	-	-	-	-	-	-
PST4 150-200/110	200x150	11 15	14	-	-	-	-	-	-	-	-	13.5	13.4	13.3	13.1	12.9	11.7	7.8	-	-	-	-	-
PST4 150-200/150	200x150	15 20	16.3	-	-	-	-	-	-	-	-	15.5	15.3	15.2	14.8	14.3	13.5	11.1	-	-	-	-	-
PST4 150-200/185	200x150	18.5 25	18.3	-	-	-	-	-	-	-	-	17.5	17.3	17.2	16.8	16.3	15.5	13.1	10	-	-	-	-
PST4 150-200/220	200x150	22 30	20.3	-	-	-	-	-	-	-	-	19.5	19.3	19.2	18.8	18.3	17.5	15.1	12	-	-	-	-
PST4 150-250/150	200x150	15 20	17.5	-	-	-	-	-	-	-	-	-	-	16.8	15.9	14.7	13.2	9.2	-	-	-	-	-
PST4 150-250/185	200x150	18.5 25	21.3	-	-	-	-	-	-	-	-	-	-	20.8	20	18.9	17.5	13.8	8.7	-	-	-	-
PST4 150-250/220	200x150	22 30	24	-	-	-	-	-	-	-	-	-	-	23.6	23	22	20.8	17.1	12	-	-	-	-
PST4 150-250/300	20																						

## MATERIAL DESCRIPTION/DESCRIPCIÓN DE MATERIAL/DESCRIPTION DU MATÉRIEL

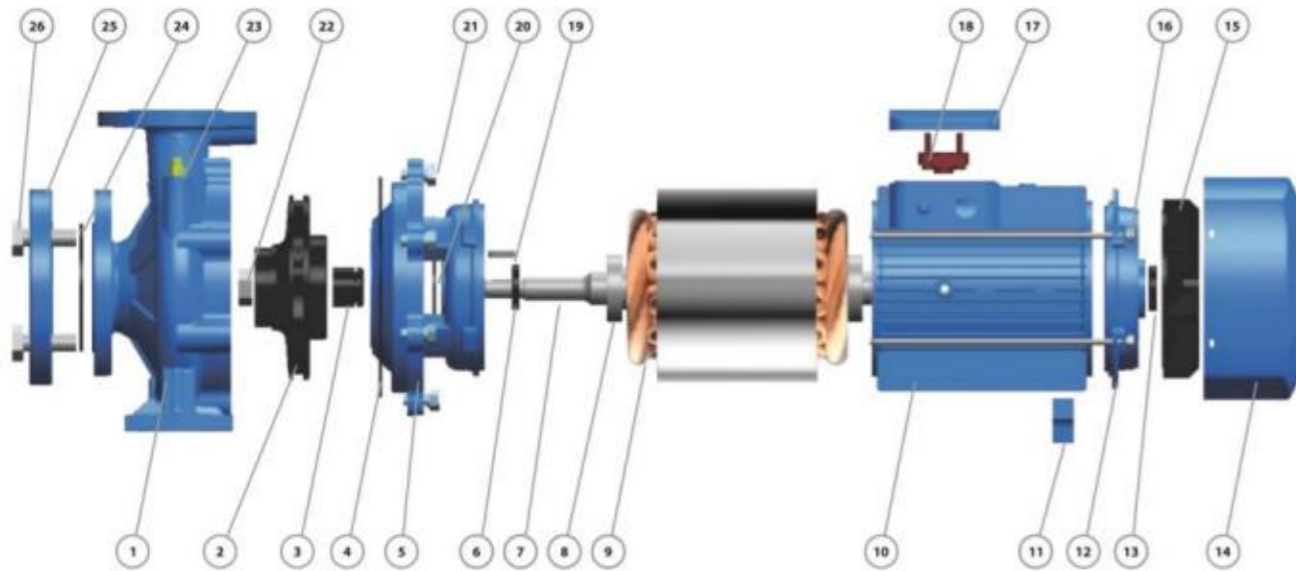

No.	Description Descripción Description	Material Material Matériel	No.	Description Descripción Description	Material Material Matériel	No.	Description Descripción Description	Material Material Matériel
1	Pump Case Cuerpo de Bomba Boîtier de pompe	Cast iron Fundición Fonte	10	Motor Case Cuerpo de Motor Boîtier du moteur	Aluminum Aluminio Aluminium	19	Impeller Key Chaveta Impulsor Clé de roue	Iron Hierro Le fer
2	Impeller Impulsor Roue	SS304/Cast iron Inox304/Fundición Inox304/Fonte	11	Support Foot Soporte Pie Pied de support	Plastic Plástico Plastique	20	Water Deflector Deflector Déflecteur d'eau	Rubber Caucho Caoutchouc
3	Mechanical Seal Cierre Mecánico Garniture mécanique	SiC/Carbon/SS304 SiC/Grafito/Inox304 SiC/Carbon/Inox304	12	Back Cover Tapa Trasera Quatrième de couverture	Cast iron Fundición Fonte	21	Connection Bolt Perno Boulon de connexion	Steel Acero Acier
4	O-ring Junta Tórica Joint torique	Rubber Caucho Caoutchouc	13	Reinforced Seal Sello Reforzado Joint renforcé	Rubber Caucho Caoutchouc	22	Impeller Nut Tuerca de Impulsor Écrou de roue	Galvanized Steel Acero Galvanizado Acier Galvanisé
5	Connection Conexión Lien	Cast iron Fundición Fonte	14	Fan Cover Tapa Ventilador Couvercle de ventilateur	Aluminum Aluminio Aluminium	23	Release Valve Tapón Cebado Soupape de décharge	Brass Bronce Laiton
6	Reinforced Seal Sello Reforzado Joint renforcé	Rubber Caucho Caoutchouc	15	Fan Ventilador Ventilateur	Plastic Plástico Plastique	24	Gasket Empaque Joint	Rubber Caucho Caoutchouc
7	Shaft Eje Arbre	SS304/45# Steel Inox 304/45# Hierro Inox304/45 #Acier	16	Through Bolt Perno Traversant le boulon	Steel Acero Acier	25	Counter Flange Contra Brida Contre bride	Galvanized Cast iron Fundición Galvanizado Fonte Galvanisée
8	Bearing Rodamiento Palier	Ball Bearing Bola Rodamiento Roulement à billes	17	Terminal Box Caja de Bomas Boîte à bornes	Aluminum Aluminio Aluminium	26	Flange Bolt Perno de Brida Boulon à bride	Steel Acero Acier
9	Wound Stator/Rotor Estator / Rotor Stator / Rotor blessure	Silicon Steel/Copper Acero al Silicio/Cobre Acier au silicium/Cuivre	18	Terminal Board Tablero de Bomas Terminal Board	Plastic Plástico Plastique			

## DIMENSIONS AND WEIGHT/DIMENSIONES Y PESOS/DIMENSIONS ET POIDS

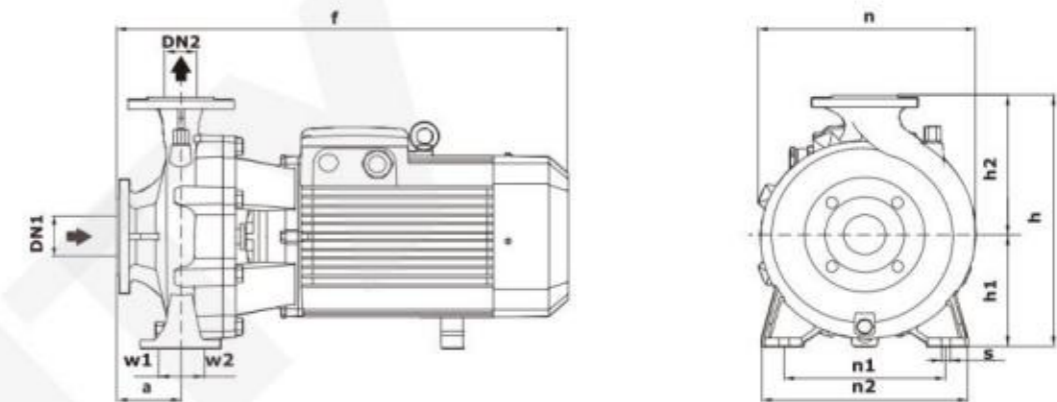

MODEL MODELO MODÈLE	DIMENSIONS/DIMENSIONES/DIMENSIONS mm													kg 3~		
	DN1	DN2	a	f	h	h1	h2	n	n1	n2	w1	w2	s			
PST 32-125/7	50	32	80	435	255	114	141	202	140	190	35	35	15	24		
PST 32-125/11			25													
PST 32-160/15			34													
PST 32-160/22			39													
PST 32-160/30			83	435	295	133	162	245	190	245	50					
PST 32-200/30			470	52												
PST 32-200/40			82	490	342	161	181	265	190	240	53					
PST 32-250/55			88	590	405	186	219	333	250	328	66					
PST 32-250/75			73													
PST 32-250/92			80													
PST 32-250/110			95													
PST 32-250/150			94	712	415	186	229	327	250	327	125					
PST 32-250/55D-75D			160	610	362	162	200	330	216	280	14	73/80				
PST 40-125/11			65	40	82	440	260	116	144	220	160	212	37	37	15	27
PST 40-125/15	29															
PST 40-125/22	34															
PST 40-160/30	48															
PST 40-160/40	80	490			305	135	170	250	190	241	50					
PST 40-200/55-75	102	560			345	162	193	282	214	267	66/73					
PST 40-250/92	100															
PST 40-250/110	116															
PST 40-250/150	94	712			415	186	229	327	250	327	49	49	146			
PST 40-250/185	155															
PST 50-125/22	41															
PST 50-125/30	50															
PST 50-125/40	52															
PST 50-160/55-75	110	560			348	164	193	270	212	262	37	37	15	64/71		
PST 50-200/92	90															
PST 50-200/110	104	722	392	186	206	307	232	310	106							
PST 50-200/150	145															
PST 50-250/150-185-220	102	720	416	186	230	330	250	327	148/153/183							
PST 65-125/40	80	65	104	580	345	162	193	275	212	280	49	49	16	56		
PST 65-125/55-75			68/74													
PST 65-160/92			90													
PST 65-160/110			106													
PST 65-160/150			110	730	425	186	239	330	232	309	134					
PST 65-200/150-185-220			111	740	140/145/185											
PST 80-125/40			56													
PST 80-125/55-75			68/74													
PST 80-160/110			117	750	357	163	194	330	212	280	113					
PST 80-160/150-185-220			88	750	435	186	250	330	255	332	143/150/183					
PST 100-160/150-185-220			125	100	130	765	435	186	250	345	262	340	55	55	16	143/150/183

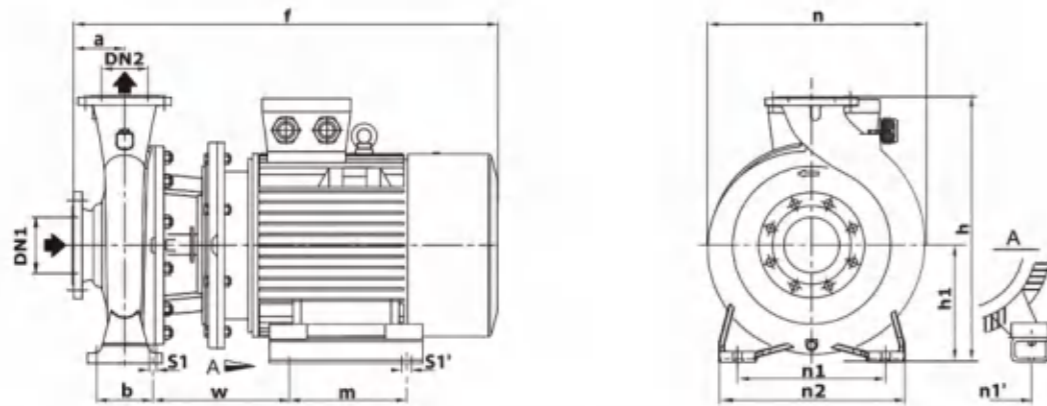

MODEL MODELO MODÈLE	DIMENSIONS/DIMENSIONES/DIMENSIONS mm															kg 3~
	DN1	DN2	a	f	h	h1	n	n1	n1'	n2	b	w	m	s1	s1'	
PST 65-250/220	80	65	116	870	420	180	369	280	279	360	120	237	241	18	15	214
PST 65-250/300	80	65	116	990	420	180	369	280	318	360	120	278	305	18	18	265
PST 65-250/370	80	65	116	990	420	180	369	280	318	360	120	278	305	18	18	285
PST 65-315/450	80	65	125	1069	505	225	440	280	356	360	120	324	311	18	18	371
PST 65-315/550	80	65	125	1160	505	225	440	280	406	360	120	373	349	18	24	450
PST 65-315/750	80	65	125	1232	505	225	440	280	457	360	120	395	368	18	24	582
PST 65-315/900	80	65	125	1283	505	225	440	280	457	360	120	395	419	18	24	617
PST 80-200/220	100	80	125	880	460	250	360	280	279	345	95	251	241	14	15	211
PST 80-200/300	100	80	125	950	460	250	360	280	318	345	95	242	305	14	18	262
PST 80-250/370	100	80	125	950	535	250	410	315	318	400	120	229	305	18	18	289
PST 80-250/450	100	80	125	980	535	250	410	315	356	400	120	235	311	18	18	362
PST 80-250/550	100	80	125	1160	535	250	410	315	406	400	120	373	349	18	24	441
PST 80-315/450	100	80	125	1069	565	250	452	315	356	400	120	324	311	18	18	381
PST 80-315/550	100	80	125	1160	565	250	452	315	406	400	120	373	349	18	24	460
PST 80-315/750	100	80	125	1232	565	250	452	315	457	400	120	395	368	18	24	592
PST 80-315/900	100	80	125	1283	565	250	452	315	457	400	120	395	419	18	24	627
PST 100-200/220	125	100	125	910	530	225	422	280	279	360	120	268	241	18	15	216
PST 100-200/300	125	100	125	1025	530	225	422	280	318	360	120	304	305	18	18	267
PST 100-200/370	125	100	125	1025	530	225	422	280	318	360	120	304	305	18	18	287
PST 100-250/450	125	100	140	1000	580	250	450	315	356	400	120	240	311	18	18	366
PST 100-250/550	125	100	140	1180	580	250	450	315	406	400	120	378	349	18	24	445
PST 100-250/750	125	100	140	1250	580	250	450	315	457	400	120	398	368	18	24	577
PST 100-250/900	125	100	140	1300	580	250	422	315	457	400	120	397	419	18	24	612
PST 100-315/750	125	100	140	1262	625	250	480	315	457	400	120	410	368	19	24	591
PST 100-315/900	125	100	140	1313	625	250	480	315	457	400	120	410	419	19	24	626
PST 100-315/1100	125	100	140	1474	625	250	480	315	508	400	120	436	406	19	28	972
PST 100-315/1320	125	100	140	1584	625	250	480	315	508	400	120	436	457	19	28	1087
PST 100-315/1600	125	100	140	1584	625	250	480	315	508	400	120	436	508	19	28	1125
PST 125-200/450	150	125	140	1099	565	250	422	315	356	400	120	339	311	19	18	378
PST 125-200/550	150	125	140	1190	565	250	422	315	406	400	120	388	349	19	24	457
PST 125-200/750	150	125	140	1262	565	250	422	315	457	400	120	410	368	19	24	589
PST 125-250/550	150	125	140	1190	605	250	500	315	406	400	120	388	349	19	24	457
PST 125-250/750	150	125	140	1262	605	250	500	315	457	400	120	410	368	19	24	589
PST 125-250/900	150	125	140	1313	605	250	500	315	457	400	120	410	419	19	24	624
PST4 65-250/30	80	65	116	606	420	180	369	280	160	360	120	147	140	18	12	71
PST4 65-250/40	80	65	116	594	420	180	369	280	190	360	120	154	140	18	12	87
PST4 65-250/55	80	65	116	638	420	180	369	280	216	360	120	193	140	18	12	98
PST4 65-315/40	80	65	125	644	505	225	440	280	190	360	120	195	140	18	12	101
PST4 65-315/55-75	80	65	125	688	505	225	440	280	216	360	120	234	140	18	12	112/130
PST4 65-315/110-150	80	65	125	858	505	225	440	280	254	360	120	283	210	18	15	163/185
PST4 80-200/30	100	80	125	606	460	250	360	280	160	345	95	151	140	14	12	68
PST4 80-200/40	100	80	125	594	460	250	360	280	190	345	95	158	140	14	12	84

MODEL MODELO MODÈLE	DIMENSIONS/DIMENSIONES/DIMENSIONS mm															kg 3~
	DN1	DN2	a	f	h	h1	n	n1	n1'	n2	b	w	m	s1	s1'	
PST4 80-250/55	100	80	125	638	535	250	410	315	216	400	120	184	140	18	12	102
PST4 80-250/75	100	80	125	638	535	250	410	315	216	400	120	184	140	18	12	120
PST4 80-250/110	100	80	125	808	535	250	410	315	254	400	120	233	210	18	15	154
PST4 80-315/55-75	100	80	125	688	565	250	452	315	216	400	120	234	140	18	12	122/140
PST4 80-315/110-150	100	80	125	858	565	250	452	315	254	400	120	283	210	18	15	173/195
PST4 80-400/185	100	80	125	902	635	280	536	315	254	400	120	283	254	18	15	251
PST4 80-400/220	100	80	125	938	635	280	536	315	279	400	120	296	241	18	15	271
PST4 80-400/300	100	80	125	1029	635	280	536	315	318	400	120	308	305	18	18	334
PST4 100-200/40	125	100	125	644	530	225	422	280	190	360	120	195	140	18	12	89
PST4 100-200/55-75	125	100	125	688	530	225	422	280	216	360	120	234	140	18	12	100/118
PST4 100-250/55-75	125	100	140	688	580	250	450	315	216	400	120	219	140	18	12	107/125
PST4 100-250/110-150	125	100	140	858	580	250	450	315	254	400	120	268	210	18	15	158/180
PST4 100-315/150	125	100	140	888	625	250	480	315	254	400	120	298	210	19	15	194
PST4 100-315/185	125	100	140	932	625	250	480	315	254	400	120	298	254	19	15	234
PST4 100-315/220	125	100	140	968	625	250	480	315	279	400	120	311	241	19	15	254
PST4 100-315/300	125	100	140	1059	625	250	480	315	318	400	120	323	305	19	18	317
PST4 100-400/300-370	125	100	140	1059	655	280	548	400	318	500	150	308	305	23	18	348/391
PST4 100-400/450	125	100	140	1099	655	280	548	400	356	500	150	324	311	23	18	418
PST4 125-200/55-75	150	125	140	718	565	250	422	315	216	400	120	249	140	19	12	107/125
PST4 125-200/110	150	125	140	888	565	250	422	315	254	400	120	298	210	19	15	170
PST4 125-250/75	150	125	140	718	605	250	500	315	216	400	120	249	140	19	12	137
PST4 125-250/110-150	150	125	140	888	605	250	500	315	254	400	120	298	210	19	15	170/192
PST4 125-250/185	150	125	140	932	605	250	500	315	254	400	120	298	254	19	15	232
PST4 125-315/185	150	125	140	932	635	280	525	400	254	500	150	283	254	23	15	252
PST4 125-315/220	150	125	140	968	635	280	525	400	279	500	150	296	241	23	15	272
PST4 125-315/300-370	150	125	140	1059	635	280	525	400	318	500	150	308	305	23	18	335/378
PST4 150-200/110-150	200	150	160	928	680	280	435	450	254	550	150	303	210	23	15	197/219
PST4 150-200/185	200	150	160	972	680	280	435	450	254	550	150	303	254	23	15	259
PST4 150-200/220	200	150	160	1008	680	280	435	450	279	550	150	316	241	23	15	279
PST4 150-250/150	200	150	160	928	715	280	510	450	254	550	150	303	210	23	15	226
PST4 150-250/185	200	150	160	972	715	280	510	450	254	550	150	303	254	23	15	266
PST4 150-250/220	200	150	160	1008	715	280	510	450	279	550	150	316	241	23	15	286
PST4 150-250/300	200	150	160	1099	715	280	510	450	318	550	150	328	305	23	18	349
PST4 150-315/370	200	150	160	1099	740	280	548	450	318	550	150	328	305	23	18	395
PST4 150-315/450	200	150	160	1139	740	280	548	450	356	550	150	344	311	23	18	422
PST4 150-315/550	200	150	160	1230	740	280	548	450	406	550	150	393	349	23	24	511
PST4 150-315/750	200	150	160	1302	740	280	548	450	457	550	150					



## PS

End suction centrifugal pump  
 Bomba centrífuga de succión final  
 Pompe centrifuge aspiration finale



n=3500 r/min



PS



PSM



PSB



PSBM

### NEW/NUEVO/NOUVEAU

#### DESCRIPTION/DESCRIPCIONES/DESCRIPTION

- Complete range with a full series of end suction pumps
  - Original design by PURITY (Patent no.201530478502.0)
  - Outstanding reliability for operation in any application
  - YE3 high efficient motor, with protection IP55 class F
  - Pump case with anti-corrosive coating
  - Customize casting logo on the bearing house as request
  - Quality NSK bearing, wear resistance mechanical seal
- Gama completa con una serie completa de bombas
  - Diseño original de PURITY (Patente no.201530478502.0)
  - Excelente fiabilidad para cualquier aplicación
  - Motor de eficiencia YE3 con Protección IP55 clase F
  - Cuerpo de bomba con tratamiento anti-corrosión
  - Personalizar el logotipo de fundición en la caja como solicitud
  - Rodamiento de marca NSK y cierre mecánico personalizado
- Gamme complète avec une série complète de pompes
  - Design original par PURITY (Brevet no.201530478502.0)
  - Fiabilité exceptionnelle pour n'importe quelle application
  - Moteur haute efficacité YE3, avec protection IP55 classe F
  - Boîtier de pompe avec revêtement anti-corrosif
  - Personnalisez le logo de coulée sur le palier comme demande
  - Roulement NSK qualité, joint mécanique de résistance à l'usure

#### APPLICATIONS/APLICACIONES/APPLICATIONS

- The impressive range end-suction pumps is compatible with an array of application areas, including water intake, heating, industrial pressure boosting, industrial liquid transfer, air-conditioning, district cooling, irrigation, fire fighting and many more.
- La impresionante gama de bombas de succión final es compatible con una variedad de áreas de aplicación, que incluyen la toma de agua, calefacción, aumento de la presión industrial, transferencia de líquido industrial, aire acondicionado, refrigeración urbana, riego, extinción de incendios y muchos más.
- La gamme impressionnante de pompes à aspiration finale est compatible avec un large éventail de domaines d'application, notamment prise d'eau, chauffage, surpression industrielle, transfert de liquide industriel, climatisation, refroidissement urbain, l'irrigation, lutte contre l'incendie et bien d'autres.

#### USING LIMITS/LÍMITES UTILIZACIÓN/UTILISATION LIMITES

- Liquid temperature between -10°C and +120°C
  - Ambient temperature between -10°C and +50°C
  - Max. working pressure 20 bar
  - Continuous service S1
- Temperatura del líquido de -10 °C hasta +120 °C
  - Temperatura ambiente de -10 °C hasta +50 °C
  - Presión máxima en el cuerpo de la bomba 20 bar
  - Funcionamiento continuo S1
- Température du liquide entre -10 °C et +120 °C
  - Température ambiante entre -10 °C et +50 °C
  - Max. pression de service 20 bar
  - Service continu S1

#### MODEL CODE/CÓDIGO MODELO/CODE MODÈLE

For example/ Por ejemplo/ Par exemple

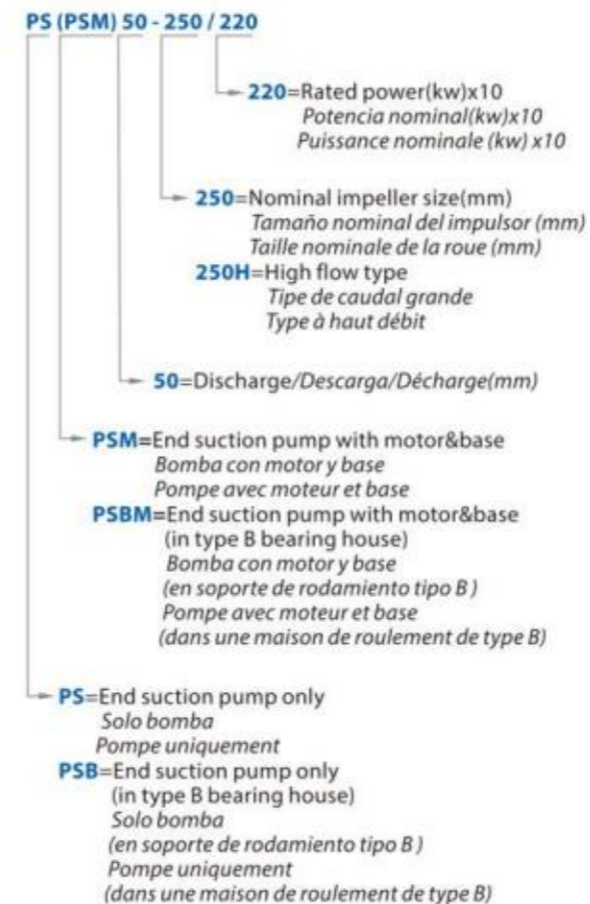

#### TECHNICAL SHEET/HOJA TÉCNICA/FICHE TECHNIQUE

Model/Modelo/Modèle	PS
Capacity/Caudal/Débit	0-1000 m <sup>3</sup> /h
Head/Altura/Hauteur	0-153 m
DN	32-150 mm
Speed/Velocidad/Vitesse	3500 rpm
T max	120 °C
Power/Potencia/Puiss.	1.5-315 kW
Casing/Cuerpo/Corps	Grey cast iron Hierro fundido gris Fonte grise
Impeller/Impulsor/Roue	Cast iron/AISI 304/Brass Hierro fundido/Inox304/Bronce Fonte/Inox 304/Laiton
Shaft/Eje/Arbre	45# steel/AISI 304 45 # acero/Inox304 45 # acier/Inox 304
Shaft seal/Sello/Scellé	Mechanical Seal Sello mecánico Garniture mécanique
Bearing/Rodamiento/Palier	Grease lubrication rolling bearing Rodamientos lubricación con grasa Roulement lubrification à la graisse



## PS4

End suction centrifugal pump  
 Bomba centrífuga de succión final  
 Pompe centrifuge aspiration finale



n=1750 r/min



PS4



PSM4



PSB4



PSBM4

### NEW/NUEVO/NOUVEAU

#### DESCRIPTION/DESCRIPCIONES/DESCRIPTION

- Complete range with a full series of end suction pumps
  - Original design by PURITY (Patent no.201530478502.0)
  - Outstanding reliability for operation in any application
  - YE3 high efficient motor, with protection IP55 class F
  - Pump case with anti-corrosive coating
  - Customize casting logo on the bearing house as request
  - Quality NSK bearing, wear resistance mechanical seal
- Gama completa con una serie completa de bombas
  - Diseño original de PURITY (Patente no.201530478502.0)
  - Excelente fiabilidad para cualquier aplicación
  - Motor de eficiencia YE3 con Protección IP55 clase F
  - Cuerpo de bomba con tratamiento anti-corrosión
  - Personalizar el logotipo de fundición en la caja como solicitud
  - Rodamiento de marca NSK y cierre mecánico personalizado
- Gamme complète avec une série complète de pompes
  - Design original par PURITY (Brevet no.201530478502.0)
  - Fiabilité exceptionnelle pour n'importe quelle application
  - Moteur haute efficacité YE3, avec protection IP55 classe F
  - Boîtier de pompe avec revêtement anti-corrosif
  - Personnalisez le logo de coulée sur le palier comme demande
  - Roulement NSK qualité, joint mécanique de résistance à l'usure

### APPLICATIONS/APLICACIONES/APPLICATIONS

- The impressive range end-suction pumps is compatible with an array of application areas, including water intake, heating, industrial pressure boosting, industrial liquid transfer, air-conditioning, district cooling, irrigation, fire fighting and many more.
- La impresionante gama de bombas de succión final es compatible con una variedad de áreas de aplicación, que incluyen la toma de agua, calefacción, aumento de la presión industrial, transferencia de líquido industrial, aire acondicionado, refrigeración urbana, riego, extinción de incendios y muchos más.
- La gamme impressionnante de pompes à aspiration finale est compatible avec un large éventail de domaines d'application, notamment prise d'eau, chauffage, surpression industrielle, transfert de liquide industriel, climatisation, refroidissement urbain, l'irrigation, lutte contre l'incendie et bien d'autres.

### USING LIMITS/LÍMITES UTILIZACIÓN/UTILISATION LIMITES

- Liquid temperature between -10°C and +120°C
  - Ambient temperature between -10°C and +50°C
  - Max. working pressure **16 bar**
  - Continuous service **S1**
- Temperatura del líquido de -10 °C hasta +120 °C
  - Temperatura ambiente de -10 °C hasta +50 °C
  - Presión máxima en el cuerpo de la bomba **16 bar**
  - Funcionamiento continuo **S1**
- Température du liquide entre -10 °C et +120 °C
  - Température ambiante entre -10 °C et +50 °C
  - Max. pression de service **16 bar**
  - Service continu **S1**

### MODEL CODE/CÓDIGO MODELO/CODE MODÈLE

For example/ Por ejemplo/ Par exemple

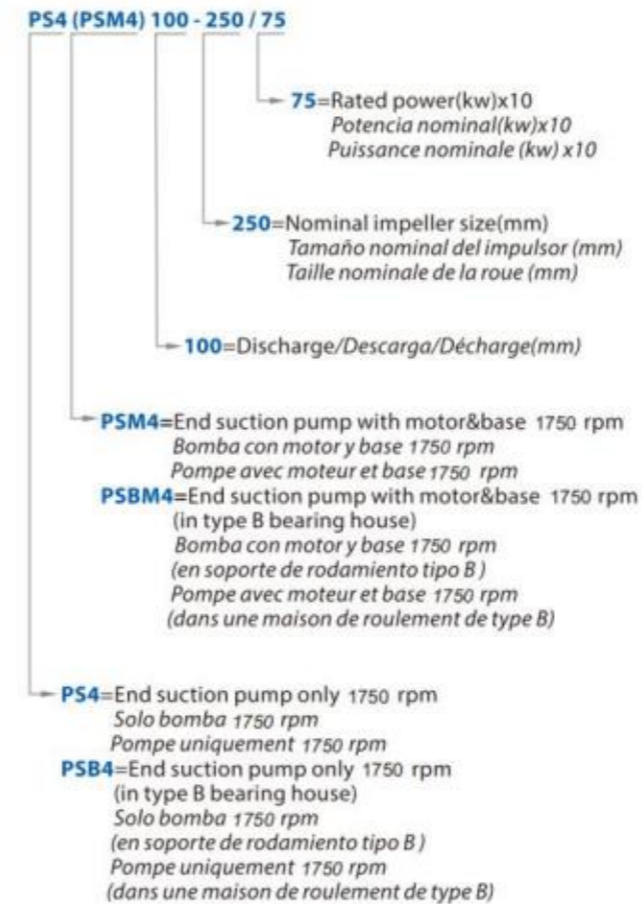

### TECHNICAL SHEET/HOJA TÉCNICA/FICHE TECHNIQUE

Model/Modelo/Modèle	PS4
Capacity/Caudal/Débit	0-1500 m <sup>3</sup> /h
Head/Altura/Hauteur	0-72 m
DN	65-250 mm
Speed/Velocidad/Vitesse	1750 rpm
T max	120 °C
Power/Potencia/Puiss.	1.1-250 kW
Casing/Cuerpo/Corps	Grey cast iron Hierro fundido gris Fonte grise
Impeller/Impulsor/Roue	Cast iron/AISI 304/Brass Hierro fundido /Inox 304/Bronce Fonte /Inox 304 /Laiton
Shaft/Eje/Arbre	45# steel/AISI304 45 # acero/Inox304 45 # acier/Inox304
Shaft seal/Sello/Scellé	Mechanical Seal Sello mecánico Garniture mécanique
Bearing/Rodamiento/Palier	Grease lubrication rolling bearing Rodamientos lubricación con grasa Roulement lubrification à la graisse

60Hz n=1750 r/min

MODEL MODELO MODÈLE	DN mm	Impr Φ mm	Power Potencia Puissance kw hp	Q=DELIVERY/CAUDAL/DÉBIT																															
				H=Head/Altura/Hauteur(m)																															
				0	106	119	132	159	185	198	220	264	317	370	396	423	476	617	661	881	1101	0	132	154	176	220	264	396	441	485	617	661	881	1101	1322
PS4 65-160/11	80x65	129	1.1 1.5	8	7.5	7.4	7.3	7	6.6	6.3	5.8	4.8	3.4	-	-	-	-	-	-	-	-	-	-	-	-	-	-	-	-	-	-	-	-	-	-

PSM4 PSB4 PSBM4 also available/también disponible/aussi disponible

Performance curve in page/Curva en página/Courbe en page 150-159

60Hz n=1750 r/min

MODEL MODELO MODÈLE	DN mm	Impr Φ mm	Power Potencia Puissance kw hp	Q=DELIVERY/CAUDAL/DÉBIT																																
				H=Head/Altura/Hauteur(m)																																
				0	132	154	176	220	264	396	441	485	617	661	881	1101	1322	1762	2203	2643	0	500	583	667	833	1000	1500	1667	1833	2333	2500	3333	4167	5000	6667	8333
PS4 125-200/55	150x125	158	5.5 7.5	11.4	11.1	11.1	11	10.9	10.8	10.2	10	9.7	8.9	8.6	6.9	-	-	-	-	-	-	-	-	-	-	-	-	-	-	-	-	-	-	-	-	-

PSM4 PSB4 PSBM4 also available/también disponible/aussi disponible

Performance curve in page/Curva en página/Courbe en page 159-170

## MATERIAL DESCRIPTION/DESCRIPCIÓN DE MATERIAL/DESCRIPTION DU MATÉRIEL

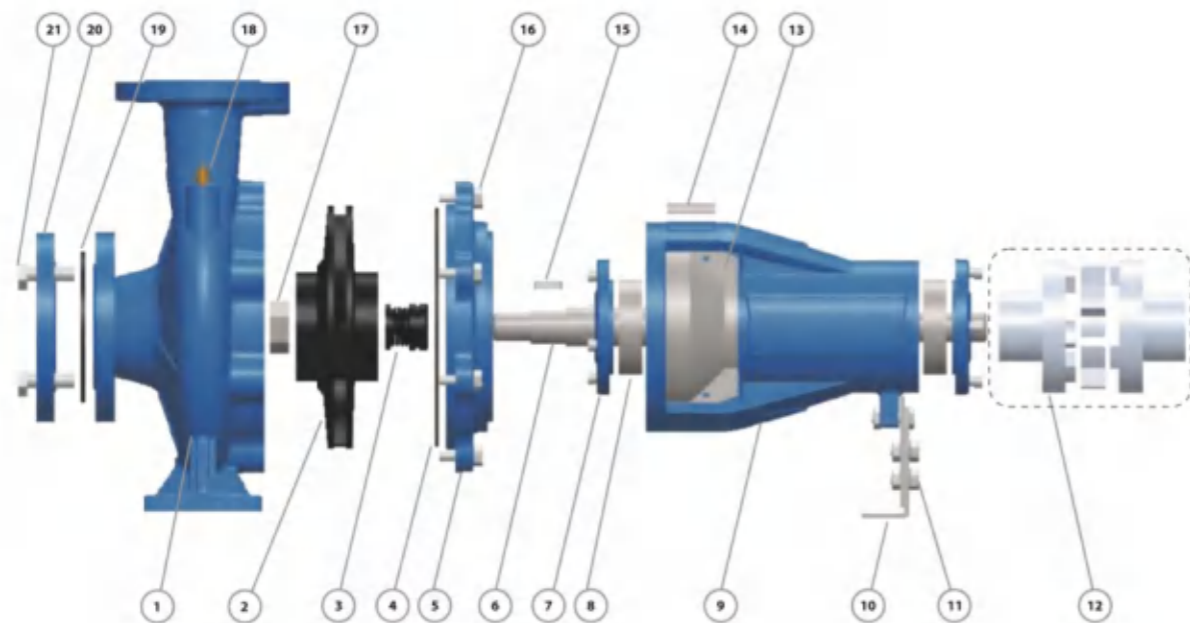

No.	Description Descripción Description	Material Material Matériel	No.	Description Descripción Description	Material Material Matériel	No.	Description Descripción Description	Material Material Matériel
1	Pump Case Cuerpo de Bomba Boîtier de pompe	Cast iron Fundición Fonte	8	Bearing Rodamiento Palier	Ball Bearing Bola Rodamiento Roulement à billes	15	Impeller Key Chaveta Impulsor Clé de roue	Iron Hierro Le fer
2	Impeller Impulsor Roue	SS304/Cast iron Inox304/Fundición Inox304/Fonte	9	Support Case Cuerpo Soporte Cas de support	Cast iron Fundición Fonte	16	Connection Bolt Perno Boulon de connexion	Steel Acero Acier
3	Mechanical Seal Cierre Mecánico Garniture mécanique	SiC/Carbon/SS304 SiC/Grafito/Inox304 SiC/Carbon/Inox304	10	Support Foot Soporte Pie Pied de support	Iron Hierro Le fer	17	Impeller Nut Tuerca de Impulsor Écrou de roue	Galvanized Steel Acero Galvanizado Acier Galvanisé
4	O-ring Junta Tórica Joint torique	Rubber Caucho Caoutchouc	11	Foot Bolt Perno Boulon de pied	Steel Acero Acier	18	Release Valve Tapón Cebado Soupape de décharge	Brass Bronce Laiton
5	Connection Conexión Lien	Cast iron Fundición Fonte	12	Coupling(Optional) Unión(Opcional) Accouplement (facultatif)	Steel Acero Acier	19	Gasket Empaque Joint	Rubber Caucho Caoutchouc
6	Shaft Eje Arbre	SS304/45# Steel Inox304/45# Hierro Acier Inox304/ 45 #	13	Case Cover Tapa Cuerpo Housse de protection	SS304 Inox304 Inox304	20	Counter Flange Contra Brida Contre bride	Galvanized Cast iron Fundición Galvanizada Fonte Galvanisée
7	Bearing Cover Tapa Rodamiento Couvercle de palier	Cast iron Fundición Fonte	14	Nameplate Letrero Plaque signalétique	Aluminum Aluminio Aluminium	21	Flange Bolt Perno de Brida Boulon à bride	Steel Acero Acier

## DIMENSIONS AND WEIGHT/DIMENSIONES Y PESOS/DIMENSIONS ET POIDS

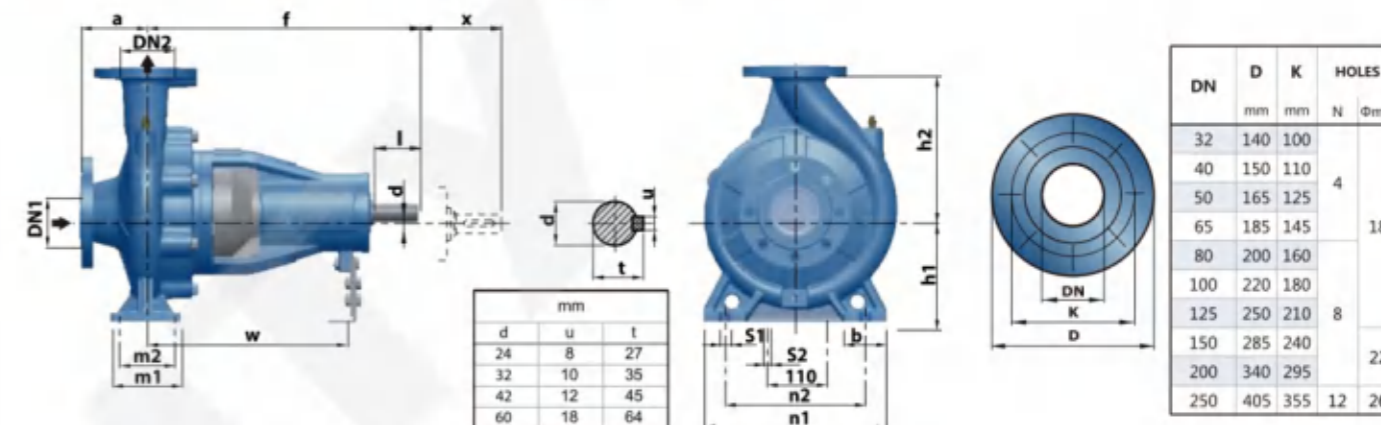

DN	D	K	HOLES	
			N	Ømm
32	140	100	4	18
40	150	110		
50	165	125		
65	185	145		
80	200	160	8	22
100	220	180		
125	250	210		
150	285	240	12	26
200	340	295		
250	405	355		

MODEL MODELO MODÈLE	DIMENSIONS/DIMENSIONES/DIMENSIONS mm																kg	
	DN1	DN2	a	f	h1	h2	b	m1	m2	n1	n2	s1	s2	w	x	d		l
32-160	50	32	80	360	132	160	55	95	70	240	190	14	14	260	100	24	50	31
32-200	50	32	80	360	160	180	55	95	70	240	190	14	14	260	100	24	50	35
32-250	50	32	80	360	160	180	55	95	70	240	190	14	14	260	100	24	50	35
40-160	65	40	80	360	132	160	50	100	70	240	190	14	14	260	100	24	50	35
40-200	65	40	100	360	160	180	55	100	70	265	212	14	14	260	100	24	50	38
40-250	65	40	100	360	180	225	65	125	95	320	250	14	14	260	100	24	50	58
40-315	65	40	125	500	200	160	65	125	95	345	280	14	14	370	140	32	80	82
50-125	65	50	100	360	132	180	50	100	70	240	190	14	14	260	100	24	50	30
50-160	65	50	100	360	160	200	55	100	70	265	212	14	14	260	100	24	50	35
50-200	65	50	100	360	160	225	50	100	70	265	212	14	14	260	100	24	50	45
50-250	65	50	100	360	180	180	65	125	95	320	250	14	14	260	100	24	50	50
50-315	65	50	125	500	225	280	65	125	95	345	280	14	14	370	140	32	80	90
65-125	80	65	100	360	160	250	65	125	95	280	212	14	14	260	100	24	50	42
65-160	80	65	100	360	160	200	65	125	95	280	212	14	14	260	100	24	50	45
65-200	80	65	100	360	180	225	65	125	95	320	250	14	14	260	140	24	50	50
65-250	80	65	100	470	200	250	80	160	120	360	280	18	14	340	140	32	80	71
65-315	80	65	125	470	225	280	80	160	120	360	280	18	14	340	140	32	80	98
80-125	100	80	100	360	180	225	65	125	95	320	250	14	14	260	140	24	50	46
80-160	100	80	100	360	180	225	65	125	95	345	250	14	14	260	140	24	50	48
80-200	100	80	100	470	200	250	65	125	95	345	280	14	14	340	140	32	80	65
80-250	100	80	100	470	200	280	80	160	120	400	315	18	14	340	140	32	80	79
80-315	100	80	125	470	250	315	80	160	120	400	315	18	14	340	140	24	50	118
80-400	100	80	125	540	280	355	80	160	120	400	315	18	14	340	140	32	80	150
100-160	125	100	125	360	200	280	80	160	120	360	280	18	14	260	140	32	80	55
100-200	125	100	125	470	200	280	80	160	120	360	280	18	14	340	140	32	80	75
100-250	125	100	125	470	225	280	80	160	120	400	315	18	14	340	140	32	80	88
100-315	125	100	140	470	250	315	80	160	120	400	315	19	14	340	140	32	80	116
100-400	125	100	140	530	280	355	100	200	150	500	400	23	14	370	140	42	110	178
125-200	150	125	140	470	250	315	80	160	120	400	315	19	14	340	140	32	80	112
125-250	150	125	140	470	250	355	80	160	120	400	315	19	14	340	140	32	80	112
125-250H	150	125	140	530	250	355	80	160	120	400	315	19	14	370	140	42	110	140
125-315	150	125	140	530	280	355	100	200	150	500	400	23	14	370	140	42	110	152
125-400	150	125	140	530	315	400	100	200	150	500	400	23	14	370	140	42	110	200
150-200	200	150	160	470	280	400	100	200	150	550	450	23	14	370	140	32	80	166
150-250	200	150	160	530	280	400	100	200	150	550	450	23	14	370	140	42	110	180
150-315	200	150	160	530	280	400	100	200	150	550	450	23	14	370	140	42	110	186
150-400	200	150	160	530	315	450	100	200	150	550	450	23	14	370	140	42	110	228
200-250	250	200	180	530	355	475	100	200	150	550	450	23	14	370	200	42	110	230
200-315	250	200	180	530	355	450	100	200	150	550	450	23	14	370	200	42	110	234
200-400	250	200	180	770	400	500	110	300	250	710	600	28	14	525	250	60	140	363
250-315	300	250	250	530	400	500	110	300	250	710	600	28	14	525	250	42	110	316
250-400	300	250	250	770	400	560	110	300	250	710	600	28	14	525	250	60	140	400

# YE3

Electric motor TEFC type  
 Motor eléctrico tipo TEFC  
 Moteur électrique type TEFC

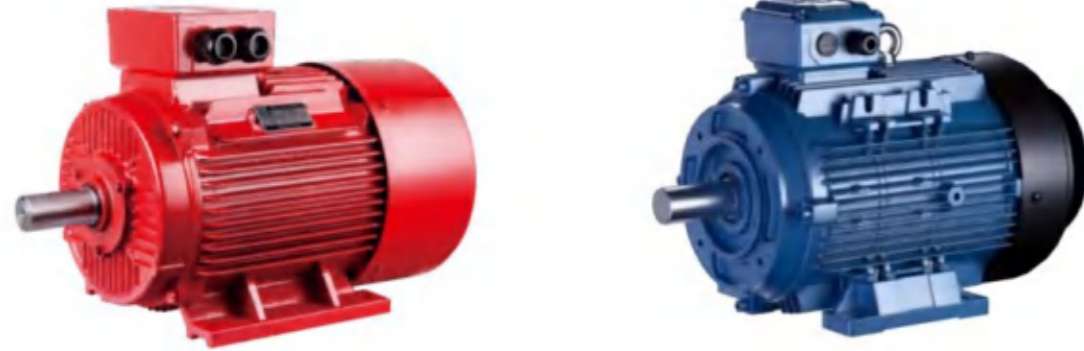

60Hz n=3600 r/min

MODEL MODELO MODÈLE	Power Potencia Puissance		Synchronous speed r/min	η %	cos Φ	A			Nm	Ts/Tn	Tmax/Tn	Is/In	dB(A)	Kgs
	kw	hp				380V	400V	415V						
YE3-80M1-2	0.75	1	3600	80.7	0.82	1.7	1.6	1.6	2.08	2.3	2.3	7	62	18.1
YE3-80M2-2	1.1	1.5	3600	82.7	0.83	2.4	2.3	2.2	3.05	2.2	2.3	7.6	62	19.5
YE3-90S-2	1.5	2	3600	84.2	0.84	3.2	3.0	2.9	4.15	2.2	2.3	7.9	67	23.3
YE3-90L-2	2.2	3	3600	85.9	0.85	4.6	4.4	4.2	6.09	2.2	2.3	7.9	67	27.1
YE3-100L-2	3	4	3600	87.1	0.87	6.0	5.7	5.5	8.30	2.2	2.3	8.5	74	38.8
YE3-112M-2	4	5.5	3600	88.1	0.88	7.8	7.4	7.1	11.07	2.2	2.3	8.5	77	48.3
YE3-132S1-2	5.5	7.5	3600	89.2	0.88	10.6	10.1	9.7	15.09	2	2.3	8.5	79	55.1
YE3-132S2-2	7.5	10	3600	90.1	0.88	14.4	13.7	13.2	20.58	2	2.3	8.5	79	69.2
YE3-160M1-2	11	15	3600	91.2	0.89	20.6	19.6	18.9	30.19	2	2.3	8.5	81	113
YE3-160M2-2	15	20	3600	91.9	0.89	27.9	26.5	25.5	41.16	2	2.3	8.5	81	123
YE3-160L-2	18.5	25	3600	92.4	0.89	34.2	32.5	31.3	50.48	2	2.3	8.5	81	142
YE3-180M-2	22	30	3600	92.7	0.89	40.5	38.5	37.1	60.03	2	2.3	8.5	83	182
YE3-200L1-2	30	40	3600	93.3	0.89	54.9	52.2	50.3	81.86	2	2.3	8.5	84	246
YE3-200L2-2	37	50	3600	93.7	0.89	67.4	64.0	61.7	100.96	2	2.3	8.5	84	265
YE3-225M-2	45	60	3600	94	0.9	80.8	76.8	74.0	122.79	2	2.3	8.0	86	323
YE3-250M-2	55	75	3600	94.3	0.9	98.5	93.6	90.2	149.22	2	2.3	8.0	89	413
YE3-280S-2	75	100	3600	94.7	0.9	133.7	127.0	122.4	203.48	1.8	2.3	7.5	91	546
YE3-280M-2	90	125	3600	95	0.9	159.9	151.9	146.4	244.18	1.8	2.3	7.5	91	569
YE3-315S-2	110	150	3600	95.2	0.9	195.1	185.3	178.6	298.44	1.8	2.3	7.5	92	897

## NEW/NUEVO/NOUVEAU

### DESCRIPTION/DESCRIPCIONES/DESCRIPTION

- Design according to IEC60034 standard
- TOTAL ENCLOSED FAN COOLING TYPE motor
- YE3 high efficient motor
- Protection IP55 class F
- Quality NSK bearing
- Continuous duty S1
- Reliable used for fire fighting system etc.
- Ambient temperature up to +50°C
- Cooling type : IC411
- Diseño de acuerdo con el estándar IEC60034
- TOTAL DE VENTILADOR CERRADO TIPO motor
- Motor de alta eficiencia YE3
- Protección IP55 clase F
- Rodamiento NSK de calidad
- Servicio continuo S1
- Fiable utilizado para el sistema de contra incendios, etc.
- Temperatura ambiente hasta + 50 °C
- Tipo de enfriamiento: IC411
- Conception selon la norme IEC60034
- TOTAL REFRROIDISSEMENT PAR VENTILATEUR MOTEUR TYPE
- Moteur haute efficacité YE3
- Protection IP55 classe F
- Roulement NSK de qualité
- Service continu S1
- Fiable utilisé pour le système de lutte contre l'incendie, etc.
- Température ambiante jusqu'à + 50 °C
- Type de refroidissement: IC411

### MODEL CODE/CÓDIGO MODELO/CODE MODÈLE

For example/Por ejemplo/Par exemple

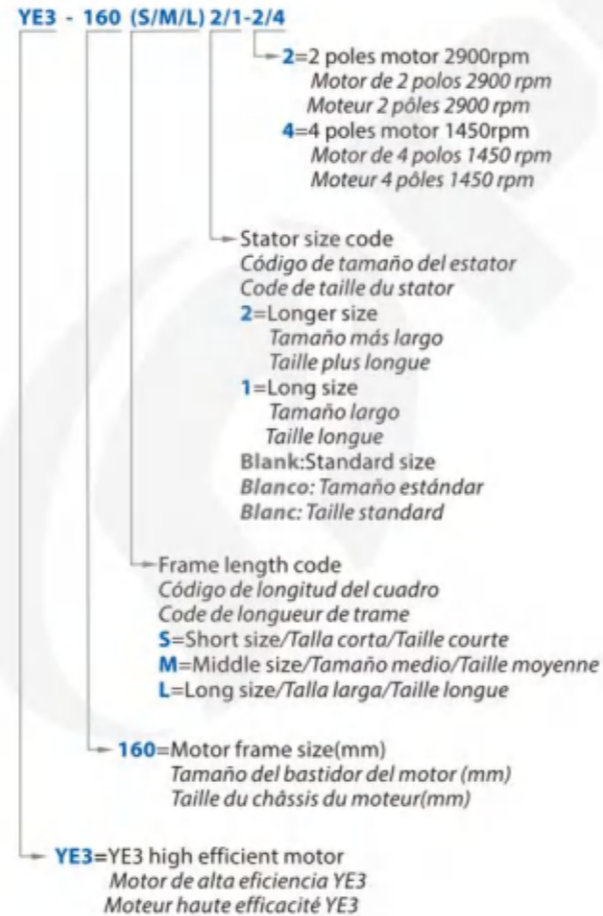

60Hz n=1800r/min

MODEL MODELO MODÈLE	Power Potencia Puissance		Synchronous speed r/min	η %	cos Φ	A			Nm	Ts/Tn	Tmax/Tn	Is/In	dB(A)	Kgs
	kw	hp				380V	400V	415V						
YE3-80M2-4	0.75	1	1800	82.5	0.75	1.8	1.7	1.6	4.21	2.4	2.3	6.6	56	17.6
YE3-90S-4	1.1	1.5	1800	84.1	0.76	2.6	2.5	2.4	6.18	2.3	2.3	6.8	59	18.4
YE3-90L-4	1.5	2	1800	85.3	0.77	3.5	3.3	3.2	8.43	2.3	2.3	7	59	24.2
YE3-100L1-4	2.2	3	1800	86.7	0.81	4.8	4.6	4.4	12.29	2.3	2.3	7.6	64	29.7
YE3-100L2-4	3	4	1800	87.7	0.82	6.3	6.0	5.8	16.75	2.3	2.3	7.6	64	41.5
YE3-112M-4	4	5.5	1800	88.6	0.82	8.4	8.0	7.7	22.34	2.3	2.3	7.8	65	46
YE3-132S-4	5.5	7.5	1800	89.6	0.83	11.2	10.6	10.3	30.54	2.2	2.3	7.9	71	63.2
YE3-132M-4	7.5	10	1800	90.4	0.84	15.0	14.3	13.7	41.64	2	2.3	7.5	71	71.2
YE3-160M-4	11	15	1800	91.4	0.85	21.5	20.4	19.7	61.08	2	2.3	7.7	73	85.1
YE3-160L-4	15	20	1800	92.1	0.86	28.8	27.4	26.4	83.28	2.2	2.3	7.8	73	121
YE3-180M-4	18.5	25	1800	92.6	0.86	35.3	33.5	32.3	102.72	2.2	2.3	7.8	76	142
YE3-180L-4	22	30	1800	93	0.86	41.8	39.7	38.3	122.15	2	2.3	7.8	76	181
YE3-200L-4	30	40	1800	93.6	0.86	56.6	53.8	51.8	164.66	2	2.3	7.3	76	209
YE3-225S-4	37	50	1800	93.9	0.86	69.6	66.1	63.7	203.07	2	2.3	7.4	78	284
YE3-225M-4	45	61	1800	94.2	0.86	84.4	80.2	77.3	246.98	2	2.3	7.4	78	328
YE3-250M-4	55	75	1800	94.6	0.86	102.7	97.6	94.0	301.87	2	2.3	7.4	79	363
YE3-280S-4	75	102	1800	95	0.88	136.3	129.5	124.8	409.29	2.2	2.3	6.9	80	442
YE3-280M-4	90	122	1800	95.2	0.88	163.2	155.0	149.4	491.14	2	2.3	6.9	80	569
YE3-315S-4	110	150	1800	95.4	0.89	196.8	187.0	180.2	600.29	2	2.2	7	88	639

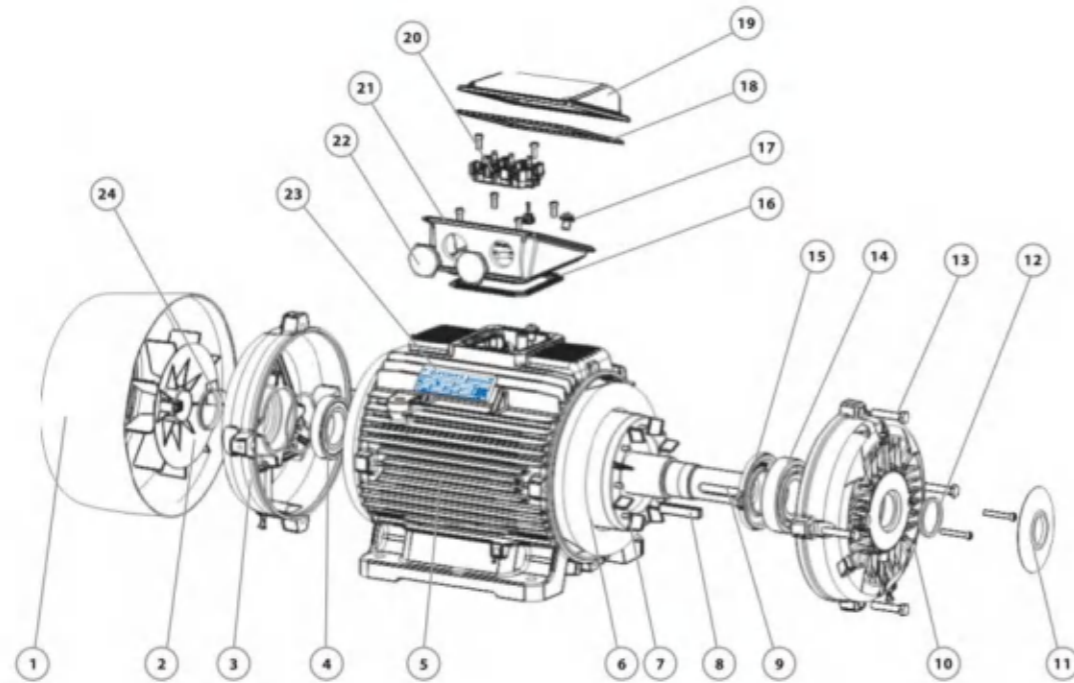
**MATERIAL DESCRIPTION/DESCRIPCIÓN DE MATERIAL/DESCRIPTION DU MATÉRIEL**

No.	Description Descripción Description	Material Material Matériel	No.	Description Descripción Description	Material Material Matériel	No.	Description Descripción Description	Material Material Matériel
1	Fan cover Tapa ventilador Capot de ventilateur	Iron Hierro Le fer	9	Shaft Eje Arbre	45# Steel 45# Hierro 45 # Acier	17	Screw Tornillo Vis	Steel Acero Acier
2	Fan Ventilador Ventilateur	Plastic Plástico Plastique	10	Front endshield Escudo frontal Pare-brise avant	Cast iron Fundición Fonte	18	Gasket Empaquetadura Joint	Rubber Caucho Caoutchouc
3	Rear endshield Escudo trasero Pare-brise arrière	Cast iron Fundición Fonte	11	Bearing cap Tapa de rodamiento Capuchon de roulement	Cast iron Fundición Fonte	19	Terminal box cover Tapa de la caja Couvercle de boîte à bornes	Aluminum Aluminio Aluminium
4	Rear bearing Rodamiento trasero Roulement arrière	Ball Bearing Bola Rodamiento Roulement à billes	12	Seal Sello Joint	Rubber Caucho Caoutchouc	20	Terminal board Tablero de terminales Bornier	Plastic Plástico Plastique
5	Frame Marco Cadre	Cast iron Fundición Fonte	13	Bolt Tornillo Boulon	Steel Acero Acier	21	Terminal box Caja de terminales Boîte à bornes	Aluminum Aluminio Aluminium
6	Wound Stator Estator herido Stator de blessure	Silicon Steel/Copper Acero al Silicio/Cobre Acier au silicium / cuivre	14	Front bearing Rodamiento delantero Roulement avant	Ball Bearing Bola Rodamiento Roulement à billes	22	Terminal box plug Enchufe de la caja Fiche de boîte à bornes	Plastic Plástico Plastique
7	Rotor Rotor Rotor	Silicon Steel Acero al Silicio Acier au silicium	15	Internal bearing cap Tapa interna de rodamiento Chapeau de palier interne	Cast iron Fundición Fonte	23	Nameplate Placa de nombre Plaque signalétique	Aluminum Aluminio Aluminium
8	Key Llave Clé	Iron Hierro Le fer	16	Gasket Empaquetadura Joint	Rubber Caucho Caoutchouc	24	Seal Sello Scellé	Rubber Caucho Caoutchouc

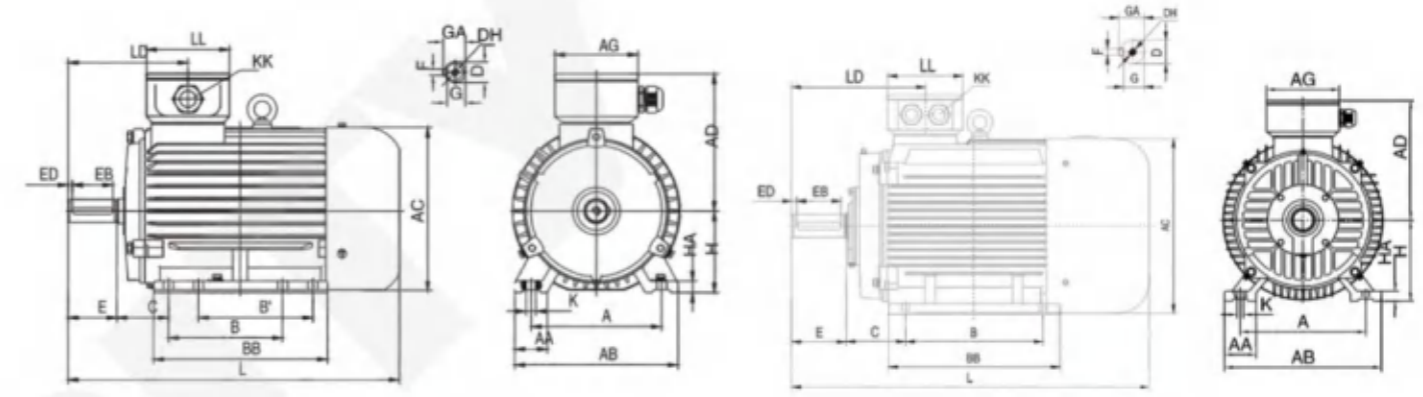
**DIMENSIONS/DIMENSIONES/DIMENSIONS**

80-132

160-355

MODEL MODELO MODÈLE	DIMENSIONS/DIMENSIONES/DIMENSIONS mm																							
	A	AA	AB	AC	AD	AG	B	BB	C	D	DH	E	EB	ED	F	G	GA	H	HA	K	KK	L	LD	LL
80	125	34	160	167	147	102	100	150	50	19	M6X16	40	30	2.5	6	15.5	21.5	80	10	4-Φ10	1-M25X1.5	304	119	102
90S	140	36	176	182.4	154.5	102	100	161	56	24	M8X19	50	40	5	8	20	27	90	12	4-Φ10	1-M25X1.5	336	143	102
90L	140	36	176	182.4	154.5	102	125	186	56	24	M8X19	50	40	5	8	20	27	90	12	4-Φ10	1-M25X1.5	361	143	102
100L	160	40	200	205.4	166	102	140	213	63	28	M10X22	60	50	5	8	24	31	100	14	4-Φ12	1-M32X1.5	406	147	102
112M	190	50	240	230	188	118	140	188	70	28	M10X22	60	50	5	8	24	31	112	15	4-Φ12	2-M32X1.5	394	147	110
132S	216	55	265	258.4	203	118	140	186	89	38	M12X28	80	65	5	10	33	41	132	18	4-Φ12	2-M32X1.5	438	172	110
132M	216	55	265	258.4	203	118	178	224	89	38	M12X28	80	65	7.5	10	33	41	132	18	4-Φ12	2-M32X1.5	476	172	110
160M	254	65	314	314	251	162	210	260	108	42	M16X36	110	90	7.5	12	37	45	160	20	4-Φ14.5	2-M40X1.5	608	256	152
160L	254	65	314	314	251	162	254	304	108	42	M16X36	110	90	10	12	37	45	160	20	4-Φ14.5	2-M40X1.5	652	256	152
180M	279	70	349	355	267	162	241	311	121	48	M16X36	110	90	10	14	42.5	51.5	180	22	4-Φ14.5	2-M40X1.5	688	271	152
180L	279	70	349	355	267	162	279	349	121	48	M16X36	110	90	10	14	42.5	51.5	180	22	4-Φ14.5	2-M40X1.5	726	271	152
200L	318	70	388	397	299	210	305	369	133	55	M20X42	110	100	10	16	49	59	200	25	4-Φ18.5	2-M50X1.5	779	296	190
225S	356	75	431	446	322	210	286	368	149	60	M20X42	140	125	5	18	53	64	225	28	4-Φ18.5	2-M50X1.5	824	329	190
225M	356	75	431	446	322	210	311	393	149	55	M20X42	110	100	7.5	16	49	59	225	28	4-Φ18.5	2-M50X1.5	819	299	190
250M	406	80	484	485	358	248	349	445	168	60	M20X42	140	125	7.5	18	53	64	250	30	4-Φ24	2-M63X1.5	910	347	218
280S	457	85	542	547	387	248	368	485	190	65	M20X42	140	125	7.5	18	58	69	280	35	4-Φ24	2-M63X1.5	982	355.5	218
280M	457	85	542	547	387	248	419	536	190	65	M20X42	140	125	7.5	18	58	69	280	35	4-Φ24	2-M63X1.5	1033	355.5	218
315S	508	120	628	620	527	320	406	570	216	65	M20X42	140	125	7.5	18	58	69	315	45	4-Φ28	2-M63X1.5	1194	397	280
315M	508	120	628	620	527	320	457	680	216	65	M20X42	140	125	7.5	18	58	69	315	45	4-Φ28	2-M63X1.5	1304	397	280
315L	508	120	628	620	527	320	508	680	216	65	M20X42	140	125	7.5	18	58	69	315	45	4-Φ28	2-M63X1.5	1304	397	280
355M	610	116	726	698	642	380	560	750	254	75	M20X42	140	130	5	20	67.5	79.5	355	52	6-Φ28	2-M63X1.5	1486	414	330
355L	610	116	726	698	642	380	630	750	254	75	M20X42	140	130	5	20	67.5	79.5	355	52	6-Φ28	2-M63X1.5	1486	414	330

**PD**

**Diesel engine for pump**  
**Motor diesel para bomba**  
**Moteur diesel pour pompe**



**NEW/NUEVO/NOUVEAU**  
**DESCRIPTION/DESCRIPCIONES/DESCRIPTION**

- Air-cooled 1-cylinder in-line naturally aspirated engines
- Water-cooling 3-to 6-cylinder naturally and turbo engines
- Advanced direct injection and combustion system
- Extremely compact dimensions, easy to assemble
- Noise-optimized technology, stronger power
- Meeting China III emission standard
- Low fuel consumption, environmental protective
- Refrigerados por aire de 1 cilindro en línea motores
- Refrigeración por agua de 3 a 6 cilindros motores
- Sistema avanzado de inyección directa y combustión
- Dimensiones extremadamente compactas, fáciles de montar
- Tecnología optimizada para el ruido, potencia más fuerte
- Cumple con el estándar de emisiones de China III
- Bajo consumo combustible, protección del medio ambiente
- Moteurs 1 cylindre à aspiration naturelle refroidis par air
- Refroidissement par eau de 3 à 6 cylindres moteurs
- Système avancé d'injection directe et de combustion
- Dimensions extrêmement compactes, faciles à assembler
- Technologie optimisée pour le bruit, puissance accrue
- Conforme à la norme d'émission China III
- Faible consommation de carburant

**MODEL CODE/CÓDIGO MODELO/CODE MODÈLE**

For example/ Por ejemplo/ Par exemple

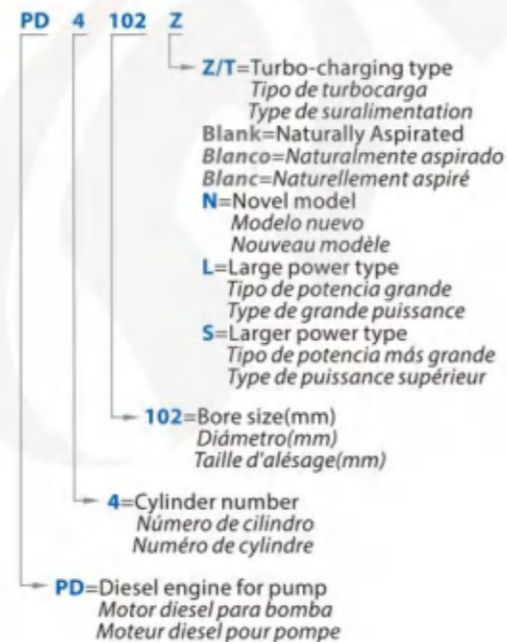

Model Modelo Modèle	178	186	188	192	380	385	480	485	490N	490	495	498	4102	4105	4108
Type Tipo Type	4 strokes, Air cooling 4 tiempos, Refrigeración por aire 4 temps, refroidissement par air				Direct Injection, 4 strokes, Water-cooling Inyección directa, 4 carreras, refrigeración por agua Injection directe, 4 temps, refroidissement par eau										
Intake Type Tipo de aspirada Type d'admission	Naturally Aspirated/Aspiración natural/Aspiration naturelle														
Bore*Stroke(mm) Diámetro*Carrera(mm) Alésage * Course(mm)	78*62	86*72	88*75	92*75	80*90	85*90	80*90	85*100	90*100	90*105	95*105	98*105	102*118	105*118	108*118
Cylinder No. Cilindro No. N° de cylindre	1	1	1	1	3	3	4	4	4	4	4	4	4	4	4
Displacement Desplazamiento Déplacement	0.296L	0.418L	0.456L	0.499L	1.357L	1.532L	1.8L	2.27L	2.54L	2.67L	2.977L	3.168L	3.857L	4.087L	4.324L
r/min	3000 3600	3000 3600	3000 3600	3000 3600	3000	3000	3000	3000	3000	3000	3000	3000	3000	3000	3000
Rated kW kW nominal kW nominale	3.7kW 4.0kW	5.7kW 6.3kW	6.6kW 7.2kW	7.5kW 8.2kW	20kW	24kW	28kW	36kW	42kW	45kW	50kW	54kW	62kW	67kW	73kW
Rated HP HP nominal HP nominale	5.0HP 5.5HP	7.8HP 8.6HP	9HP 10HP	10.2HP 12HP	27HP	32HP	38HP	49HP	58HP	61HP	68HP	73HP	85HP	91HP	99HP
Fuel Consumption(g/kw.h) El consumo combustible Consumation carburant	280.3 282.5	273.5 285.7	273.5 285.7	275 281	228	228	215	228	228	228	228	228	228	238	238
Start Voltage Voltaje de inicio Tension de démarrage	12V	12V	12V	12V	12V	12V	12V	12V	12V	12V	12V	12V	12V	24V	24V
Speed regulation type Tipo regulación Type régulation vitesse	Mechanical/Mecánico/Mécanique														
Including Incluso Comprenant	Radiator, Fan, Starter, charge alternator, Air filter, Muffler, Stop Solenoid, PTO shaft, Fuel Tank, Meter Panel Radiador, ventilador, arrancadora, alternador carga, filtro aire, silenciador, Solenoide parada, eje toma fuerza, tanque combustible, panel medidor Radiateur, ventilateur, démarreur, alternateur charge, filtre air, silencieux, solénoïde d'arrêt, arbre prise force, réservoir carburant, panneau compteur														

Model Modelo Modèle	485Z	490NZ	498Z	4102Z	4105Z	4108Z	490T	4108T	4108TL	6102NT	6102T	6102TL	6126T	6126TL	6126TS
Type Tipo Type	Direct Injection, 4 strokes, Water-cooling Inyección directa, 4 carreras, refrigeración por agua Injection directe, 4 temps, refroidissement par eau														
Intake Type Tipo de aspirada Type d'admission	Turbo-charging/Turbocarga/Turbo-charge									Naturally Turbo-charging/Turbocarga/Turbo-charge					
Bore*Stroke(mm) Diámetro*Carrera(mm) Alésage * Course(mm)	85*100	90*100	98*105	102*118	105*118	108*118	90*102	108*125	108*125	102*118	102*118	102*118	126*130	126*130	126*155
Cylinder No. Cilindro No. N° de cylindre	4	4	4	4	4	4	4	4	4	6	6	6	6	6	6
Displacement Desplazamiento Déplacement	2.27L	2.54L	3.168L	3.857L	4.087L	4.324L	2.6L	3.8L	3.8L	5.78L	5.78L	5.78L	9.726L	9.726L	9.726L
r/min	3000	3000	3000	3000	3000	3000	3000	3000	3000	3000	3000	3000	3000	3000	3000
Rated kW kW nominal kW nominale	44kW	50kW	60kW	73kW	75kW	83kW	55kW	75kW	90kW	110kW	125kW	165kW	200kW	250kW	300kW
Rated HP HP nominal HP nominale	60HP	68HP	81HP	99HP	102HP	113HP	75HP	100HP	125HP	150HP	170HP	225HP	270HP	340HP	410HP
Fuel Consumption(g/kw.h) El consumo combustible Consumation carburant	228	228	228	238	238	238	228	218	218	229	229	229	250	250	250
Start Voltage Voltaje de inicio Tension de démarrage	12V	12V	12V	24V	24V	24V	12V	24V	24V	24V	24V	24V	24V	24V	24V
Speed regulation type Tipo regulación Type régulation vitesse	Mechanical/Mecánico/Mécanique												Electronic Electrónico Électronique		
Including Incluso Comprenant	Radiator, Fan, Starter, charge alternator, Air filter, Muffler, Stop Solenoid, PTO shaft, Fuel Tank, Meter Panel Radiador, ventilador, arrancadora, alternador carga, filtro aire, silenciador, Solenoide parada, eje toma fuerza, tanque combustible, panel medidor Radiateur, ventilateur, démarreur, alternateur charge, filtre air, silencieux, solénoïde d'arrêt, arbre prise force, réservoir carburant, panneau compteur														



**PV**

**Vertical multistage centrifugal pump**  
**Bomba centrífuga multietapa vertical**  
**Pompe centrifuge multicellulaire verticale**



60Hz n=3500 r/min

**NEW/NUEVO/NOUVEAU**  
 DESCRIPTION/DESCRIPCIONES/DESCRIPTION

- New design noiseless, energy-saving multistage pump
  - Ensuring durability and easy in operation
  - A wide range of products will meet every requirement
  - YE3 high efficient motor, with protection IP55 class F
  - Impeller in techno-polimer
  - Suction and discharge port in cast iron G20 thread
  - Quality NSK bearing, wear resistance mechanical seal
  - Compact and proportional design
- Nuevo diseño bomba que silencioso y ahorra energía
  - Asegurando durabilidad y fácil operación
  - Una amplia gama de productos satisfará todos los requisitos
  - Motor de alta eficiencia YE3, con protección IP55 clase F
  - Impulsor en tecnopolímero
  - Puerto de succión y descarga en rosca G20 de hierro fundido
  - Rodamiento de marca NSK y cierre mecánico personalizado
  - El diseño compacto y proporcional
- Nouvelle conception de pompe silencieuse et économe
  - Assurer la durabilité et facile à utiliser
  - Une large gamme de produits répondra à toutes les exigences
  - Moteur haute efficacité YE3, avec protection IP55 classe F
  - Turbine en techno-polimer
  - Orifice d'aspiration et de refoulement en filetage G20 fonte
  - Roulement NSK qualité, joint mécanique résistance à l'usure
  - La conception compacte et proportionnelle

**APPLICATIONS/APLICACIONES/APPLICATIONS**

- The high efficiency and noiseless operation which allows these pumps to be used in conditions households, irrigation, car washes, fire protection systems, air conditioning and lifting installations water pressure in the network.
- La alta eficiencia y el funcionamiento silencioso que permite que estas bombas se utilicen en hogares, riego, lavado de autos, sistemas de protección contra incendios, aire acondicionado e instalaciones de elevación de presión de agua en la red.
- Le rendement élevé et le fonctionnement silencieux qui permettent à ces pompes d'être utilisées dans des conditions domestiques, d'irrigation, de lave-autos, de systèmes de protection contre l'incendie, de climatisation et d'installations de levage sous pression d'eau dans le réseau.

**USING LIMITS/LÍMITES UTILIZACIÓN/UTILISATION LIMITES**

- Liquid temperature between -10°C and +120°C
  - Ambient temperature between -10°C and +50°C
  - Max. working pressure 25 bar
  - Continuous service S1
- Temperatura del líquido de -10 °C hasta +120 °C
  - Temperatura ambiente de -10 °C hasta +50 °C
  - Presión máxima en el cuerpo de la bomba 25 bar
  - Funcionamiento continuo S1
- Température du liquide entre -10 °C et +120 °C
  - Température ambiante entre -10 °C et +50 °C
  - Max. pression de service 25 bar
  - Service continu S1

MODEL MODELO MODÈLE	DN mm	Power Potencia Puissance kw hp	Q=DELIVERY/CAUDAL/DÉBIT																						
			us gpm	0	5	11	13	16	19	21	24	26	29	32	37	42	48	53	58	63	69	74	79		
			l/min	0	20	40	50	60	70	80	90	100	110	120	140	160	180	200	220	240	260	280	300		
				1.2	2.4	3	3.6	4.2	4.8	5.4	6	6.6	7.2	8.4	9.6	10.8	12	13.2	14.4	15.6	16.8	18			
				H=Head/Altura/Hauteur(m)																					
PV 4x4/1.5	25x25	1.1 1.5	52	49	46	44	41	39	37	33	30	27	23												
PV 4x6/2	25x25	1.5 2	77	74	69	66	63	58	55	50	45	40	34												
PV 4x8/3	25x25	2.2 3	104	99	92	88	84	78	73	66	60	53	45												
PV 4x10/4	25x25	3 4	129	124	116	110	104	97	91	83	75	66	57												
PV 4x13/5.5	25x25	4 5.5	168	161	150	143	136	126	119	108	97	86	74												
PV 4x16/7.5	25x25	5.5 7.5	206	198	185	177	167	156	146	133	119	106	91												
PV 6x3/1.5	32x32	1.1 1.5	40				36	35	33	31	30	28	26	22	17										
PV 6x5/2	32x32	1.5 2	66				60	58	55	52	50	47	43	36	28										
PV 6x7/3	32x32	2.2 3	92				85	81	78	73	70	66	61	51	40										
PV 6x9/4	32x32	3 4	119				109	104	100	94	90	84	78	65	51										
PV 6x12/5.5	32x32	4 5.5	159				145	139	133	125	120	113	104	87	68										
PV 6x16/7.5	32x32	5.5 7.5	197				180	173	165	156	150	140	130	108	85										
PV 8x4/2	40x40	1.5 2	53							44	42	41	39	37	33	29	23	17	12						
PV 8x6/3	40x40	2.2 3	79							66	64	61	59	56	50	44	35	26	18						
PV 8x8/4	40x40	3 4	105							88	85	82	78	74	66	58	46	34	24						
PV 8x10/5.5	40x40	4 5.5	132							110	106	102	98	93	83	73	58	43	30						
PV 8x13/7.5	40x40	5.5 7.5	171							143	138	133	127	121	108	95	75	56	39						
PV 8x17/10	40x40	7.5 10	224							187	180	173	167	158	141	124	99	73	51						
PV 12x3/2	50x50	1.5 2	44											43	42	41	40	38	36	33	30	27	24	20	17
PV 12x4/3	50x50	2.2 3	59											58	57	55	53	50	48	44	40	36	32	27	23
PV 12x5/4	50x50	3 4	73											72	71	69	66	63	60	55	50	45	40	34	29
PV 12x7/5.5	50x50	4 5.5	102											101	99	97	92	88	84	77	70	63	56	48	40
PV 12x9/7.5	50x50	5.5 7.5	132											130	127	124	119	113	108	99	90	81	71	61	51

Performance curve in page/Curva en página/Courbe en page 170-171

MODEL MODELO MODÈLE	DN mm	Power Potencia Puissance kw hp	Q=DELIVERY/CAUDAL/DÉBIT																					
			us gpm	0	26	53	79	106	132	159	185	211												
			l/min	0	100	200	300	400	500	600	700	800												
				6	12	18	24	30	36	42	48													
				H=Head/Altura/Hauteur(m)																				
PV 30x5/10	65x65	7.5 10	105		100	93	86		78	67	54	36	4											
PV 30x6/12	65x65	9.2 12.5	126		120	112	103		94	80	65	44	5											
PV 30x8/15	65x65	11 15	168		158	149	138		124	106	86	58	6											

Performance curve in page/Curva en página/Courbe en page 171

**MODEL CODE/CÓDIGO MODELO/CODE MODÈLE**

For example/ Por ejemplo/ Par exemple

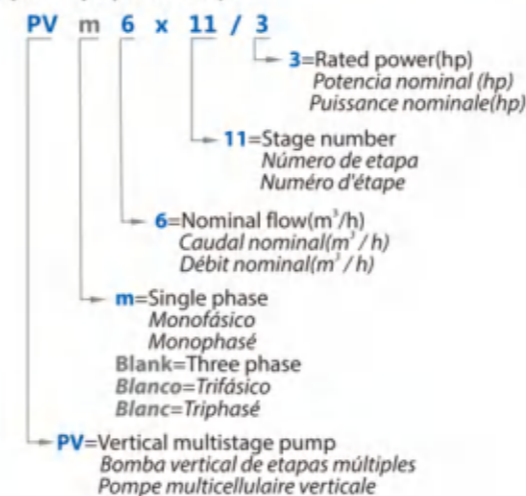
**TECHNICAL SHEET/HOJA TÉCNICA/FICHE TECHNIQUE**

Model/Modelo/Modèle	PV	
Capacity/Caudal/Débit	0-48	m <sup>3</sup> /h
Head/Altura/Hauteur	0-224	m
DN	25-65	mm
Speed/Velocidad/Vitesse	3500	rpm
T max	120	°C
Power/Potencia/Puiss.	1.1-11	kW
Voltage/Voltaje/Tension	220/380/400/440	V
HZ	60	
Class/Clase/Classe	Class F	
IP	IP 55	
Duty/Servicio/Devoir	S1 continuous	
Casing/Cuerpo/Corps	Grey Cast iron/Hierro fundido gris/Fonte grise	
Impeller/Impulsor/Roue	Plastic/Plástico/Plastique	
Shaft/Eje/Arbre	SS304/Inox 304/Inox 304	
Shaft seal/Sello/Scellé	Mechanical Seal/Sello mecánico/Garniture mécanique	

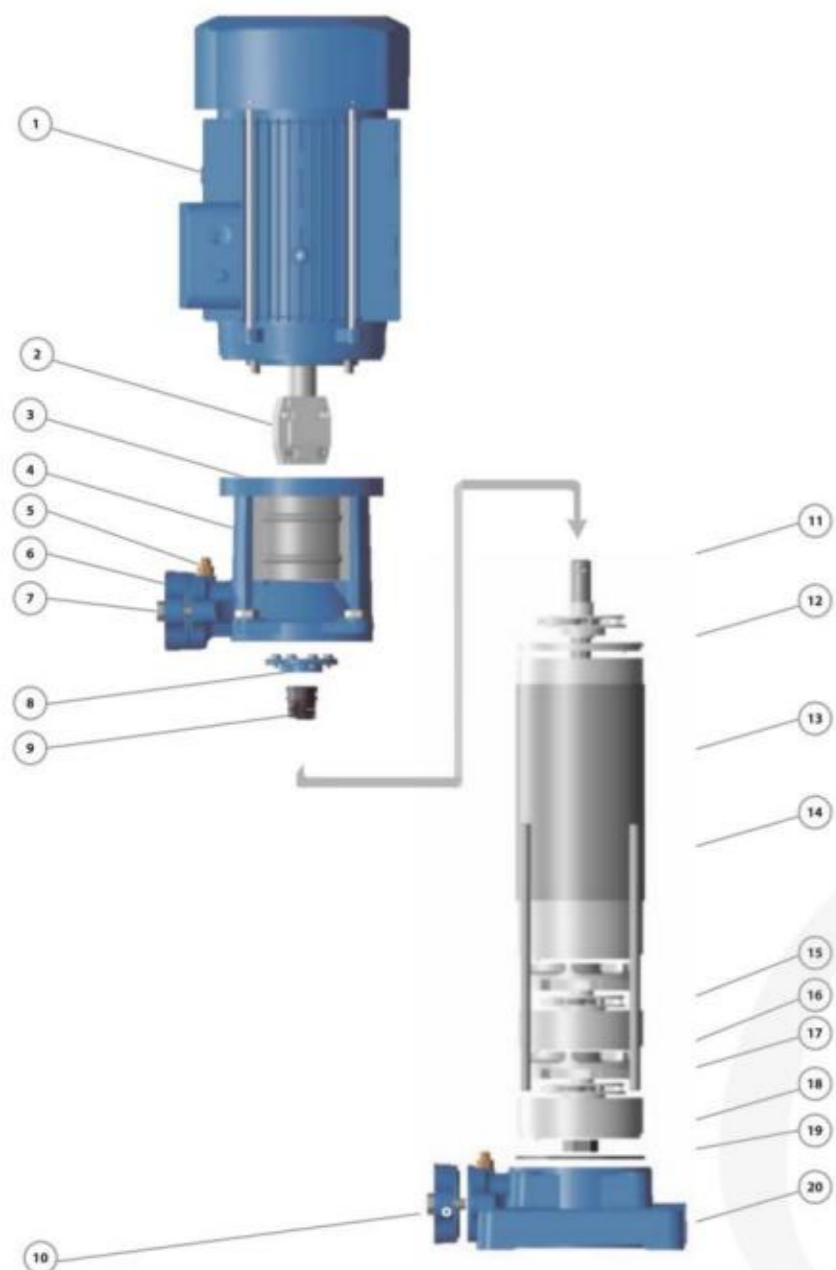

No.	Description Descripción Description	Material Material Matériel
1	Motor Motor Moteur	IP55 Class F IP55 Clase F IP55 classe F
2	Coupling Unión Couplage	Iron Hierro Le fer
3	Discharge Body Cuerpo Impulsión Corps de décharge	Cast iron Fundición Fonte
4	Cover Tapa Couverture	SS304 Inox 304 Inox 304
5	Release Valve Tapón Cebado Soupape de décharge	Brass Bronce Laiton
6	Discharge Impulsión Décharge	Cast iron Fundición Fonte
7	Bolt Perno Boulon	Steel Acero Acier
8	Seal Cover Tapa Cierre Couvercle de joint	Cast iron Fundición Fonte
9	Mechanical Seal Cierre Mecánico Garniture mécanique	SiC/Carbon/SS304 SiC/Grafito/Inox304 SiC/Carbon /Inox304
10	Suction Aspiración Suction	Cast iron Fundición Fonte
11	Pump Shaft Eje Arbre de pompe	SS304 Inox304 Inox304
12	Diffuser Top Cover Tapa Tapa Difusor Couvercle diffuseur	Technopolimer Tecnopolimero Technopolimer
13	Pump Cover Tapa Bomba Couvercle de pompe	SS304 Inox 304 Inox 304
14	Through Bolt Perno Traversant le boulon	Steel Acero Acier
15	Diffuser Cover Tapa Difusor Couvercle de diffuseur	Technopolimer with SS304 ring Tecnopolimero con Inox anillo Technopolimer avec anneau Inox
16	Diffuser Difusor Diffuseur	Technopolimer with SS304 ring Tecnopolimero con Inox anillo Technopolimer avec anneau Inox
17	Impeller Impulsor Roue	Technopolimer Tecnopolimero Technopolimer
18	Impeller Nut Tuerca de Impulsor Écrou de roue	Galvanized Steel Acero Galvanizado Acier Galvanisé
19	O-ring Junta Tórica Joint torique	Rubber Caucho Caoutchouc
20	Suction Body Cuerpo Aspiración Corps d'aspiration	Cast iron Fundición Fonte

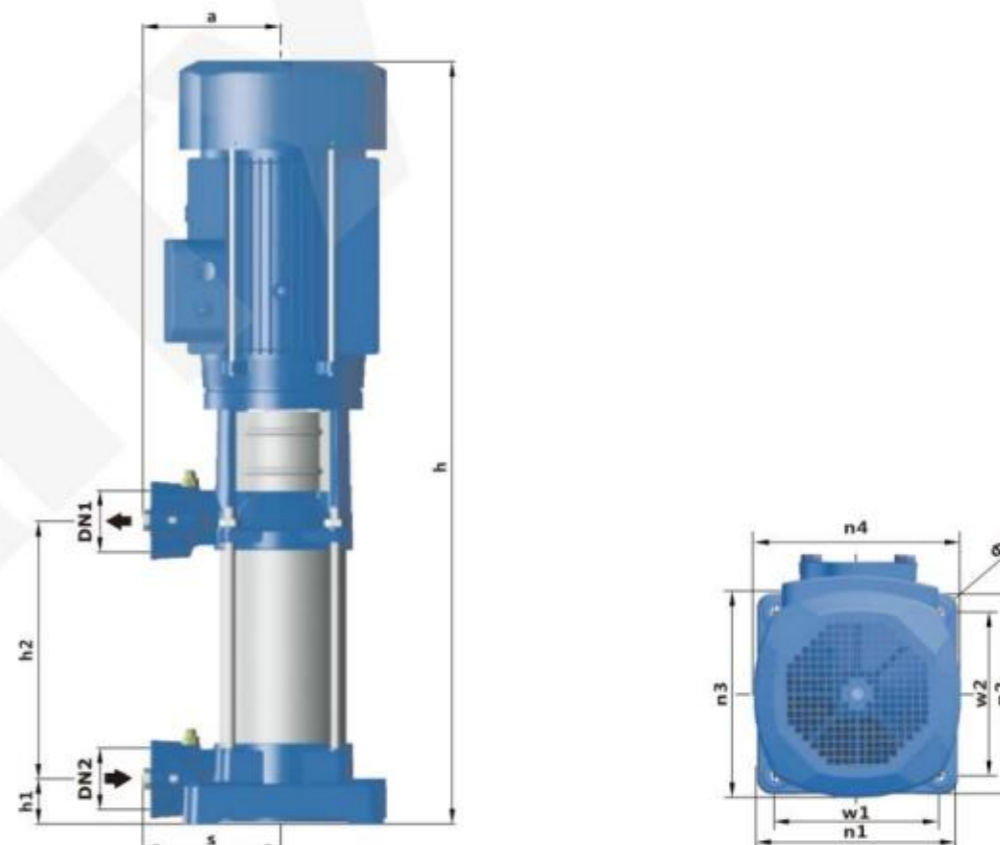

MODEL/ MODELO/ MODÈLE		DIMENSIONS/ DIMENSIONES/ DIMENSIONS mm															kg	
Single-phase Monofásico Monophasé	Three-phase Trifásico Triphasé	DN1	DN2	N	a	s	h	h1	h2	w1	w2	n1	n2	n3	n4	d	1~	3~
PV 4x4/1.5	PV 4x4/1.5	25/32	25/32	4	141	141	615.5	45.5	156.5	165	165	202	202	175	175	12	27.0	26.0
PV 4x6/2	PV 4x6/2	25/32	25/32	6	141	141	685.5	45.5	226.5	165	165	202	202	175	175	12	32.0	31.0
PV 4x8/3	PV 4x8/3	25/32	25/32	8	141	141	755.5	45.5	296.5	165	165	202	202	175	175	12	37.0	36.0
PV 4x10/4	PV 4x10/4	25/32	25/32	10	141	141	825.5	45.5	366.5	165	165	202	202	195	195	12	47.0	46.0
-	PV 4x13/5.5	25/32	25/32	13	141	141	977.5	45.5	471.5	165	165	202	202	195	195	12	-	51.0
-	PV 4x16/7.5	25/32	25/32	16	141	141	1132.5	45.5	576.5	165	165	202	202	204	204	12	-	61.0
PV 6x3/1.5	PV 6x3/1.5	25/32	25/32	3	141	141	580.5	45.5	121.5	165	165	202	202	175	175	12	26.0	25.0
PV 6x5/2	PV 6x5/2	25/32	25/32	5	141	141	650.5	45.5	191.5	165	165	202	202	175	175	12	31.0	30.0
PV 6x7/3	PV 6x7/3	25/32	25/32	7	141	141	720.5	45.5	261.5	165	165	202	202	175	175	12	36.0	35.0
PV 6x9/4	PV 6x9/4	25/32	25/32	9	141	141	837.5	45.5	331.5	165	165	202	202	195	195	12	46.0	45.0
-	PV 6x12/5.5	25/32	25/32	12	141	141	942.5	45.5	436.5	165	165	202	202	195	195	12	-	50.0
-	PV 6x16/7.5	25/32	25/32	16	141	141	1132.5	45.5	576.5	165	165	202	202	204	204	12	-	60.0
PV 8x4/2	PV 8x4/2	40/50	40/50	4	141	141	615.5	45.5	156.5	165	165	202	202	175	175	12	30.0	29.0
PV 8x6/3	PV 8x6/3	40/50	40/50	6	141	141	685.5	45.5	226.5	165	165	202	202	175	175	12	35.0	34.0
PV 8x8/4	PV 8x8/4	40/50	40/50	8	141	141	802.5	45.5	296.5	165	165	202	202	195	195	12	45.0	44.0
-	PV 8x10/5.5	40/50	40/50	10	141	141	872.5	45.5	366.5	165	165	202	202	195	195	12	-	49.0
-	PV 8x13/7.5	40/50	40/50	13	141	141	1027.5	45.5	471.5	165	165	202	202	204	204	12	-	59.0
-	PV 8x17/10	40/50	40/50	17	141	141	1167.5	45.5	611.5	165	165	202	202	204	204	12	-	64.0
PV 12x3/2	PV 12x3/2	40/50	40/50	3	141	141	580.5	45.5	121.5	165	165	202	202	175	175	12	28.0	27.0
PV 12x4/3	PV 12x4/3	40/50	40/50	4	141	141	615.5	45.5	156.5	165	165	202	202	175	175	12	33.0	32.0
PV 12x5/4	PV 12x5/4	40/50	40/50	5	141	141	697.5	45.5	191.5	165	165	202	202	195	195	12	41.0	40.0
-	PV 12x7/5.5	40/50	40/50	7	141	141	767.5	45.5	261.5	165	165	202	202	195	195	12	-	45.0
-	PV 12x9/7.5	40/50	40/50	9	141	141	887.5	45.5	331.5	165	165	202	202	204	204	12	-	55.0
-	PV 12x11/10	40/50	40/50	11	141	141	957.5	45.5	401.5	165	165	202	202	204	204	12	-	62.0
-	PV 12x15/15	40/50	40/50	15	141	141	1127.5	45.5	541.5	165	165	202	202	260	260	12	-	80.0
-	PV 30x5/10	50/65	50/65	5	170	170	939	62	309	187	187	230	230	260	260	12	-	84.0
-	PV 30x6/12	50/65	50/65	6	170	170	993	62	362.5	187	187	230	230	260	260	12	-	90.0
-	PV 30x8/15	50/65	50/65	8	170	170	1100	62	469.5	187	187	230	230	260	260	12	-	97.0



PVT/PVS

S.S.304 vertical multistage pump  
 Bomba de etapas múltiples inox304  
 Pompe multicellulaire verticale inox304



NEW/NUEVO/NOUVEAU

DESCRIPTION/DESCRIPCIONES/DESCRIPTION

- SS304 vertical, multistage centrifugal pump
- The suction and discharge ports on the same level
- PVT pump head and base are in cast iron
- PVT pump impeller and shaft are in stainless steel
- PVS pump all wetted parts are in stainless steel
- YE3 high efficient motor, with protection IP55 class F
- Quality bearing, wear resistance mechanical seal
- Liquid temperature between -10°C and +120°C
- *Inox 304 bomba centrifuga vertical de etapas múltiples*
- *Los puertos de succión y descarga en el mismo nivel*
- *El cabezal y la base de la bomba PVT son de hierro fundido*
- *El impulsor y el eje de la bomba PVT son de acero inoxidable*
- *PVS todas las partes húmedas son de acero inoxidable*
- *Motor de alta eficiencia YE3, con protección IP55 clase F*
- *Rodamiento de marca NSK y cierre mecánico personalizado*
- *Temperatura del líquido entre -10 °C y + 120 °C*
- *Pompe centrifuge multicellulaire verticale inox 304*
- *Les orifices d'aspiration et de refoulement au même niveau*
- *La tête et la base de la pompe PVT sont en fonte.*
- *Roue et arbre de pompe PVT en acier inoxydable*
- *PVS toutes les pièces en contact avec le fluide sont en inox*
- *Moteur haute efficacité YE3, avec protection IP55 classe F*
- *Roulement NSK qualité, joint mécanique résistance à l'usure*
- *Température du liquide entre -10°C et + 120°C*

APPLICATIONS/APLICACIONES/APPLICATIONS

- The stainless steel multistage pumps are suitable for industrial processing systems, washing and cleaning systems, pumping of acids and alkalis, filtration systems, water pressure boosting, water treatment, HVAC, irrigation, fire protection systems etc.
- Las bombas multietapa de acero inoxidable son adecuadas para sistemas de procesamiento industrial, sistemas de lavado y limpieza, bombeo de ácidos y álcalis, sistemas de filtración, aumento de la presión del agua, HVAC, riego, sistemas de protección contra incendios, etc.*
- Les pompes à plusieurs étages en acier inoxydable conviennent systèmes de traitement industriel, systèmes de lavage et de nettoyage, pompage des acides et des alcalis, systèmes de filtration, à la surpression, traitement de l'eau, CVC, à l'irrigation, systèmes de protection contre les incendies, etc.*

MODEL CODE/CÓDIGO MODELO/CODE MODÈLE

For example/Par ejemplo/Par exemple

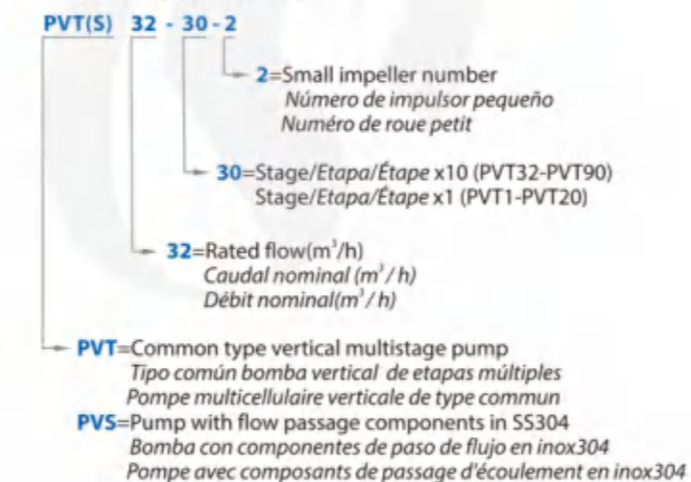

60Hz n=3500 r/min

MODEL MODELO MODÈLE	DN mm	Power Potencia Puissance kw hp	Q=DELIVERY/CAUDAL/DÉBIT																		
			H=Head/Altura/Hauteur(m)																		
			2.6	3.5	4.4	5.3	6.2	6.6	7	7.9	8.8	11	13	15	18	20	22	26	31	35	
			10	13	17	20	23	25	27	30	33	42	50	58	67	75	83	100	117	133	
			0.6	0.8	1	1.2	1.4	1.5	1.6	1.8	2	2.5	3	3.5	4	4.5	5	6	7	8	
PVT 1-2	25x25	0.37 0.5	17.5	17	16.5	16	15.5	15.3	15	14	13	-	-	-	-	-	-	-	-		
PVT 1-3	25x25	0.37 0.5	26.5	26	25	24	23	22.5	22	21	20	-	-	-	-	-	-	-	-		
PVT 1-4	25x25	0.37 0.5	35	34	33	32	31	30.5	30	28	26	-	-	-	-	-	-	-	-		
PVT 1-5	25x25	0.55 0.75	43	42	41	40	39	38.5	38	35	33	-	-	-	-	-	-	-	-		
PVT 1-6	25x25	0.55 0.75	52	51	50	48	47	46	45	43	39	-	-	-	-	-	-	-	-		
PVT 1-7	25x25	0.75 1	60	59	58	56	55	54	52	50	46	-	-	-	-	-	-	-	-		
PVT 1-8	25x25	0.75 1	68	67	65	64	62	61	59	57	53	-	-	-	-	-	-	-	-		
PVT 1-9	25x25	0.75 1	76	75	74	73	71	69	66	64	60	-	-	-	-	-	-	-	-		
PVT 1-10	25x25	1.1 1.5	85	84	83	81	78	76	74	72	67	-	-	-	-	-	-	-	-		
PVT 1-11	25x25	1.1 1.5	95	93	90	87	85	83	81	78	73	-	-	-	-	-	-	-	-		
PVT 1-12	25x25	1.1 1.5	103	102	98	96	92	90	88	86	79	-	-	-	-	-	-	-	-		
PVT 1-13	25x25	1.1 1.5	112	110	107	105	100	98	95	93	86	-	-	-	-	-	-	-	-		
PVT 1-15	25x25	1.5 2	127	125	123	121	117	115	112	107	99	-	-	-	-	-	-	-	-		
PVT 1-17	25x25	1.5 2	144	141	139	137	132	128	124	120	112	-	-	-	-	-	-	-	-		
PVT 1-19	25x25	2.2 3	160	157	155	153	147	144	141	134	124	-	-	-	-	-	-	-	-		
PVT 1-21	25x25	2.2 3	177	174	172	168	162	158	153	147	138	-	-	-	-	-	-	-	-		
PVT 1-23	25x25	2.2 3	193	190	188	184	174	171	167	161	152	-	-	-	-	-	-	-	-		
PVT 1-25	25x25	3 4	210	207	205	202	192	188	184	176	164	-	-	-	-	-	-	-	-		
PVT 2-2	25x25	0.55 0.75	-	-	26	25	24	24	24	23	22	21	18	16	12	9	-	-	-		
PVT 2-3	25x25	0.75 1	-	-	39	38	37	36	35	34	33	31	27	24	19	15	-	-	-		
PVT 2-4	25x25	1.1 1.5	-	-	52	50	49	48	47	46	45	42	36	32	26	20	-	-	-		
PVT 2-5	25x25	1.1 1.5	-	-	65	63	61	60	59	58	57	52	46	41	32	25	-	-	-		
PVT 2-6	25x25	1.1 1.5	-	-	78	76	75	74	73	71	69	63	56	49	40	30	-	-	-		
PVT 2-7	25x25	1.5 2	-	-	91	89	87	86	85	83	81	74	66	57	47	35	-	-	-		
PVT 2-9	25x25	2.2 3	-	-	117	115	112	111	110	107	104	95	86	75	61	45	-	-	-		
PVT 2-11	25x25	2.2 3	-	-	143	140	137	136	134	131	128	116	104	90	75	56	-	-	-		
PVT 2-13	25x25	3 4	-	-	171	168	165	163	161	156	152	139	126	108	90	66	-	-	-		
PVT 2-15	25x25	3 4	-	-	195	191	188	186	184	180	176	160	142	125	103	77	-	-	-		
PVT 2-18	25x25	4 5.5	-	-	234	232	229	228	225	218	212	195	171	151	126	94	-	-	-		
PVT 3-2	25x25	0.37 0.5	-	-	-	-	-	17.5	17	17	16	15	14	13	11	9	8	-	-		
PVT 3-3	25x25	0.55 0.75	-	-	-	-	-	26.5	26	26	25	24	23	20	18	15	12	-	-		
PVT 3-4	25x25	0.55 0.75	-	-	-	-	-	35	35	34	34	32	30	27	25	20	17	-	-		
PVT 3-5	25x25	0.75 1	-	-	-	-	-	44	44	43	42	40	38	33	31	26	23	-	-		
PVT 3-6	25x25	1.1 1.5	-	-	-	-	-	51	51	50	50	48	45	40	37	32	27	-	-		
PVT 3-7	25x25	1.1 1.5	-	-	-	-	-	61	61	60	59	56	52	46	43	38	31	-	-		
PVT 3-8	25x25	1.1 1.5	-	-	-	-	-	70	69	68	67	64	61	53	49	44	35	-	-		
PVT 3-9	25x25	1.5 2	-	-	-	-	-	78	78	77	77	72	68	60	56	50	40	-	-		
PVT 3-10	25x25	1.5 2	-	-	-	-	-	87	86	85	84	81	76	68	63	55	44	-	-		
PVT 3-11	25x25	1.5 2	-	-	-	-	-	96	95	94	92	87	82	74	69	59	48	-	-		
PVT 3-12	25x25	2.2 3	-	-	-	-	-	104	103	102	100	96	90	79	73	63	52	-	-		
PVT 3-13	25x25	2.2 3	-	-	-	-	-	112	111	110	109	104	98	86	80	69	57	-	-		
PVT 3-15	25x25	2.2 3	-	-	-	-	-	129	128	127	126	120	112	99	93	81	65	-	-		
PVT 3-17	25x25	2.2 3	-	-	-	-	-	147	146	145	143	137	128	114	106	91	74	-	-		
PVT 3-19	25x25	3 4	-	-	-	-	-	165	164	162	160	153	142	126	118	102	82	-	-		
PVT 3-21	25x25	3 4	-	-	-	-	-	183	182	180	178	170	160	141	129	112	91	-	-		
PVT 3-23	25x25	3 4	-	-	-	-	-	200	199	196	194	185	174	154	142	122	98	-	-		
PVT 3-25	25x25	4 5.5	-	-	-	-	-	217	216	213	211	202	187	167	154	134	108	-	-		
PVT 4-2	32x32	0.75 1	-	-	-	-	-	-	-	-	-	-	26	25	24	23	22	21	19	16	14
PVT 4-3	32x32	1.1 1.5	-	-	-	-	-	-	-	-	-	-	39	38	37	36	34	32	28	24	21
PVT 4-4	32x32	1.5 2	-	-	-	-	-	-	-	-	-	-	52	50	49	48	46	44	38	35	31
PVT 4-5	32x32	2.2 3	-	-	-	-	-	-	-	-	-	-	65	62	61	60	58	55	49	44	39
PVT 4-6	32x32	2.2 3	-	-	-	-	-	-	-	-	-	-	78	75	74	72	70	67	59	54	47
PVT 4-7	32x32	3 4	-	-	-	-	-	-	-	-	-	-	92	88	86	84	81	78	69	62	55
PVT 4-8	32x32	3 4	-	-	-	-	-	-	-	-	-	-	104	100	98	95	93	90	79	72	63
PVT 4-10	32x32	4 5.5	-	-	-	-	-	-	-	-	-	-	130	125	123	120	117	113	102	90	80
PVT 4-12	32x32	4 5.5	-	-	-	-	-	-	-	-	-	-	156	150	148	145	141	136	122	109	96
PVT 4-14	32x32	5.5 7.5	-	-	-	-	-	-	-	-	-	-	182	176	173	170	165	159	145	129	112
PVT 4-16	32x32	5.5 7.5	-	-	-	-	-	-	-	-	-	-	207	201	199	196	190	183	165	146	128

PVS also available/también disponible/aussi disponible

Performance curve in page/Curva en página/Courbe en page 171-172



## MATERIAL DESCRIPTION/DESCRIPCIÓN DE MATERIAL/DESCRIPTION DU MATÉRIEL

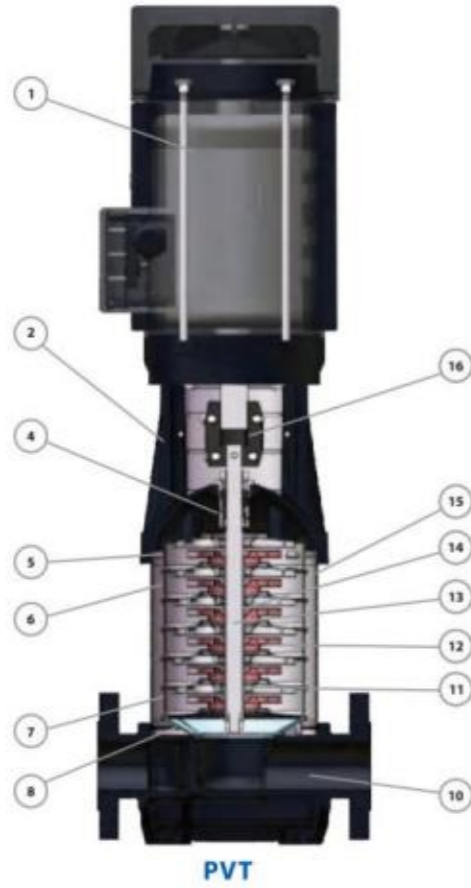

PVT

No.	Description Descripción Description	Material Material Matériel	No.	Description Descripción Description	Material Material Matériel
1	Motor Motor Moteur	IP55 Class F IP55 Clase F IP55 classe F	9	-	-
2	Pump Case Cuerpo de Bomba Boîtier de pompe	Cast iron Fundición Fonte	10	Inlet&Outlet Chamber Cámara de entrada y salida Chambre d'entrée et de sortie	Cast iron Fundición Fonte
3	-	-	11	Bearing Cojinete Palier	Tungsten Carbide Carburo de Tungsteno Le carbure de tungstène
4	Mechanical Seal Sello Mecánico Garniture mécanique	SS304 Inox 304 Inox 304	12	Impeller Impulsor Roue	SS304 Inox 304 Inox 304
5	Top Diffuser Difusor Tope Diffuseur supérieur	SS304 Inox 304 Inox 304	13	Shaft Eje Arbre	SS304 Inox 304 Inox 304
6	Diffuser Difusor Diffuseur	SS304 Inox 304 Inox 304	14	Impeller Sleeve Casquillo Impulsor Manchon de roue	SS304 Inox 304 Inox 304
7	Support Diffuser Difusor Soporte Diffuseur de support	SS304 Inox 304 Inox 304	15	Cylinder Cilindro Cylindre	SS304 Inox 304 Inox 304
8	Inducer Inductor Inducteur	SS304 Inox 304 Inox 304	16	Coupling Unión Coulpage	Carbon Steel Acero al Carbono Acier Carbone

## MATERIAL DESCRIPTION/DESCRIPCIÓN DE MATERIAL/DESCRIPTION DU MATÉRIEL

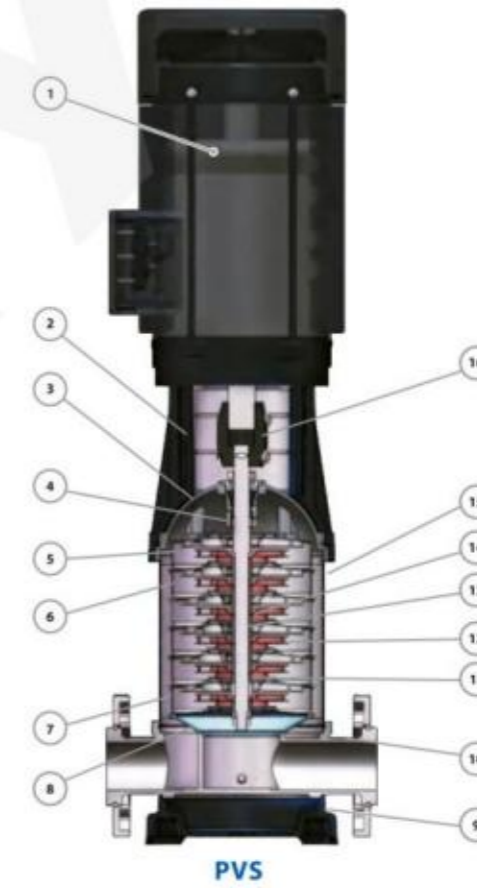

PVS

No.	Description Descripción Description	Material Material Matériel	No.	Description Descripción Description	Material Material Matériel
1	Motor Motor Moteur	IP55 Class F IP55 Clase F IP55 classe F	9	Base Plate Placa Base Plaque de base	Cast iron Fundición Fonte
2	Pump Case Cuerpo de Bomba Boîtier de pompe	Cast iron Fundición Fonte	10	Inlet&Outlet Chamber Cámara de entrada y salida Chambre d'entrée et de sortie	SS304 Inox304 Inox304
3	Seal Base Soporte Sello Seal Base	SS304 Inox 304 Inox 304	11	Bearing Cojinete Palier	Tungsten Carbide Carburo de Tungsteno Le carbure de tungstène
4	Mechanical Seal Sello Mecánico Garniture mécanique	SS304 Inox 304 Inox 304	12	Impeller Impulsor Roue	SS304 Inox 304 Inox 304
5	Top Diffuser Difusor Tope Diffuseur supérieur	SS304 Inox 304 Inox 304	13	Shaft Eje Arbre	SS304 Inox 304 Inox 304
6	Diffuser Difusor Diffuseur	SS304 Inox 304 Inox 304	14	Impeller Sleeve Casquillo Impulsor Manchon de roue	SS304 Inox 304 Inox 304
7	Support Diffuser Difusor Soporte Diffuseur de support	SS304 Inox 304 Inox 304	15	Cylinder Cilindro Cylindre	SS304 Inox 304 Inox 304
8	Inducer Inductor Inducteur	SS304 Inox 304 Inox 304	16	Coupling Unión Coulpage	Carbon Steel Acero al Carbono Acier Carbone

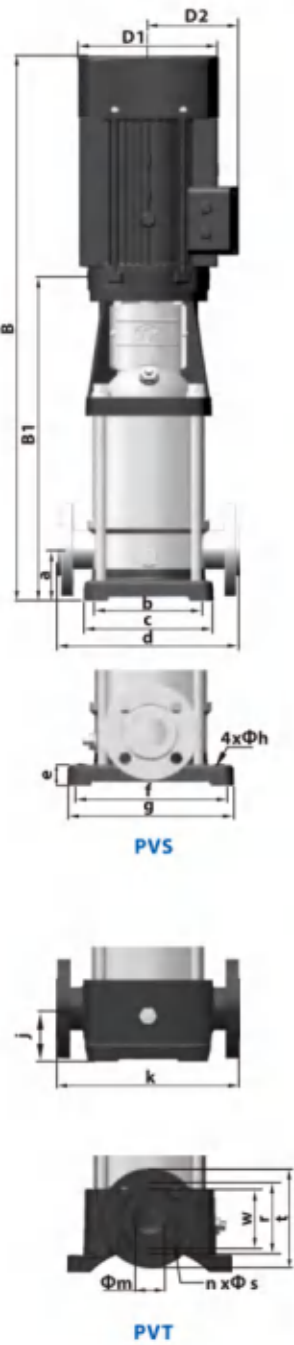

MODEL MODELO MODÈLE	B1	B	D1	D2	COMMON COMUN COMMUN	kg
1-2	258	483	148	117	DN=25 a=50 b=100 c=150 d=210 e=20 f=180 g=210 h=13 j=75 k=250 m=32 n=4 r=85 s=14 t=115 w=60	20
1-3	276	501	148	117		20
1-4	294	519	148	117		21
1-5	312	537	148	117		22
1-6	330	555	148	117		23
1-7	358	603	170	142		26
1-8	376	621	170	142		27
1-9	394	639	170	142		28
1-10	412	657	170	142		29
1-11	430	675	170	142		29
1-12	448	693	170	142		30
1-13	466	711	170	142		31
1-15	512	802	190	155		37
1-17	548	838	190	155		38
1-19	584	874	190	155		41
1-21	620	910	190	155		42
1-23	656	946	190	155		43
1-25	702	1047	197	165		51
2-2	258	483	148	117		21
2-3	286	531	170	142		24
2-4	304	549	170	142		25
2-5	322	567	170	142		26
2-6	340	585	170	142		26
2-7	368	658	190	155		32
2-9	404	694	190	155		36
2-11	440	730	190	155	37	
2-13	486	831	197	165	44	
2-15	522	867	197	165	45	
2-18	576	931	230	188	54	
3-2	258	483	148	117	20	
3-3	276	501	148	117	21	
3-4	294	519	148	117	22	
3-5	322	567	170	142	25	
3-6	340	585	170	142	26	
3-7	358	603	170	142	27	
3-8	376	621	170	142	27	
3-9	404	694	190	155	33	
3-10	422	712	190	155	34	
3-11	440	730	190	155	34	
3-12	458	748	190	155	37	
3-13	476	766	190	155	38	
3-15	512	802	190	155	39	
3-17	548	838	190	155	40	
3-19	594	939	197	165	48	
3-21	630	975	197	165	49	
3-23	666	1011	197	165	50	
3-25	702	1057	230	188	58	

MODEL MODELO MODÈLE	B1	B	D1	D2	COMMON COMUN COMMUN	kg	
4-2	286	531	170	142	DN=32 a=50 b=100 c=150 d=210 e=20 f=180 g=210 h=13 j=75 k=250 m=32 n=4 r=100 s=18 t=140 w=60	24	
4-3	313	558	170	142		25	
4-4	350	640	190	155		31	
4-5	376	667	190	155		34	
4-6	404	694	190	155		35	
4-7	441	786	197	165		42	
4-8	468	813	197	165		42	
4-10	522	877	230	188		51	
4-12	576	931	230	188		52	
4-14	650	1040	260	208		64	
4-16	704	1094	260	208		66	
8-2-1	347	592	170	142		DN=40 a=80 b=130 c=199 d=260 e=25 f=215 g=247 h=14 j=80 k=280 m=50 n=4 r=110 s=18 t=150 w=80	32
8-2	357	647	190	155			38
8-3	387	677	190	155			41
8-4	427	772	197	165			49
8-5	457	802	197	165			50
8-6	487	842	230	188			58
8-8	567	957	260	208	71		
8-10	627	1017	260	208	80		
8-12	687	1077	260	208	82		
8-14	835	1335	330	255	153		
10-1	347	592	170	142	40		
10-2	347	637	190	155	47		
10-3	377	667	190	155	51		
10-4	417	762	197	165	60		
10-5	447	792	197	165	61		
10-6	477	832	230	188	70		
10-7	517	907	260	208	92		
10-8	547	937	260	208	93		
10-9	577	967	260	208	94		
10-10	607	997	260	208	98		
10-12	667	1057	260	208	100		
10-14	747	1247	330	255	157		
10-16	807	1307	330	255	159		
10-17	837	1337	330	255	160		
12-1	357	602	170	142	DN=50 a=90 b=130 c=199 d=260 e=35 f=215 g=247 h=14 j=90 k=300 m=50 n=4 r=125 s=18 t=165 w=80	32	
12-2	367	657	190	155		41	
12-3	407	762	230	188		56	
12-4	457	847	260	208		69	
12-5	487	877	260	208		71	
12-6	517	907	260	208		77	
12-7	547	937	260	208		78	
12-8	665	1165	330	255		147	
12-10	725	1225	330	255		151	
12-12	785	1285	330	255		164	
12-14	845	1345	330	255		167	

MODEL MODELO MODÈLE	B1	B	D1	D2	COMMON COMUN COMMUN	kg
16-2-1	397	687	190	155	DN=50 a=90 b=130 c=199 d=260 e=35 f=215 g=247 h=14 j=90 k=300 m=50 n=4 r=125 s=18 t=165 w=80	42
16-2	407	762	230	188		56
16-3	472	862	260	208		68
16-4	517	907	260	208		75
16-5	650	1150	330	255		148
16-6	695	1195	330	255		150
16-7	740	1240	330	255		161
16-8	785	1285	330	255		163
16-10	875	1425	330	255		186
20-1	397	687	190	155		41
20-2	407	762	230	188	56	
20-3	472	862	260	208	69	
20-4	517	907	260	208	79	
20-5	650	1150	330	255	148	
20-6	695	1195	330	255	150	
20-7	740	1240	330	255	162	
20-8	785	1285	330	255	163	
20-10	875	1425	330	255	187	
32-10-1	505	850	197	165	DN=65 a=105 b=170 c=225 d=320 e=30 f=240 g=298 h=14 j=105 k=320 m=74 n=8 r=145 s=18 t=185 w=107	73
32-10	505	860	230	188		81
32-20-2	575	965	260	208		95
32-20	575	965	260	208		101
32-30-2	645	1035	330	255		104
32-30	750	1250	330	255		172
32-40-2	820	1320	330	255		176
32-40	820	1320	330	255		186
32-50-2	890	1390	330	255		191
32-50	890	1440	330	255		211
32-60-2	960	1510	330	255		216
32-60	960	1510	330	255		216
32-70-2	1030	1605	360	285		255
32-70	1030	1605	360	285		255
32-80-2	1100	1675	400	310		259
32-80	1100	1750	400	310		315
32-90-2	1170	1820	400	310	319	
32-90	1170	1820	400	310	319	
32-100-2	1240	1890	400	310	324	

MODEL MODELO MODÈLE	B1	B	D1	D2	COMMON COMUN COMMUN	kg
45-10-1	561	952	260	208	DN=80 a=140 b=190 c=245 d=365 e=45 f=266 g=330 h=14 j=140 k=365 m=80 n=8 r=160 s=18 t=200 w=120	101
45-10	561	952	260	208		106
45-20-2	748	1248	330	255		178
45-20	748	1248	330	255		188
45-30-2	828	1378	330	255		213
45-30	828	1378	330	255		213
45-40-2	908	1483	360	285		253
45-40	908	1558	400	310		309
45-50-2	988	1638	400	310		313
45-50	988	1638	400	310		313
45-60-2	1068	1718	400	310	340	
45-60	1068	1718	400	310	340	
45-70-2	1148	1833	460	340	404	
45-70	1148	1833	460	340	404	
64-10-1	561	951	260	208	DN=100 a=140 b=190 c=245 d=365 e=45 f=266 g=330 h=14 j=140 k=365 m=100 n=8 r=180 s=18 t=220 w=150	109
64-10	671	1171	330	255		177
64-20-2	754	1254	330	255		187
64-20	754	1329	360	285		248
64-30-2	836	1411	360	285		252
64-30	836	1486	400	310		313
64-40-2	919	1569	400	310		336
64-40	919	1604	460	340		398
64-50-2	1001	1686	460	340	402	
90-10-1	571	1071	330	255	DN=100 a=140 b=199 c=255 d=380 e=45 f=280 g=348 h=14 j=140 k=380 m=100 n=8 r=180 s=18 t=220 w=150	177
90-10	571	1071	330	255		188
90-20-2	773	1323	330	255		211
90-20-1	773	1348	360	285		248
90-20	773	1423	400	310		304
90-30-2	865	1515	400	310		330
90-30-1	865	1515	400	310		330
90-30	865	1550	460	340		392
90-40-2	957	1642	460	340		396



**PEDJ**  
**Fire fighting system**  
**Sistema de contra incendio**  
**Systeme anti-incendie**

**NEW/NUEVO/NOUVEAU**  
**DESCRIPTION/DESCRIPCIONES/DESCRIPTION**

- ♦ Fire pumps are designed for whole operational life, the maximum reliability is always the first priority
- ♦ The components affixed onto a steel framing structure
- ♦ Each controller has its own individual pressure sensing line
- ♦ The suction line should never include a strainer
- ♦ Check valve and butterfly valve in the discharge line
- ♦ NFPA 20 not allows suction from negative level for end suction and split case pumps
- ♦ Bombas contra incendios están diseñadas para vida operativa completa, la máxima fiabilidad es siempre primera prioridad
- ♦ Los componentes se fijarán en una estructura armazón de acero
- ♦ Cada controlador tendrá su propia línea detección presión
- ♦ La línea de succión nunca debe incluir un filtro
- ♦ Válvula de retención y mariposa en la línea de descarga
- ♦ NFPA 20 no permite la succión desde el nivel negativo para la succión final y las bombas de carcasa dividida
- ♦ Pompes à incendie sont conçues pour toute la durée de vie opérationnelle, la fiabilité maximale est toujours la première priorité
- ♦ Tous les composants fixés sur une structure charpente en acier
- ♦ Chaque contrôleur possède sa propre ligne détection pression
- ♦ La conduite d'aspiration ne doit jamais comprendre de crépine
- ♦ Clapet anti-retour et papillon dans la conduite de refoulement
- ♦ NFPA 20 n'autorise pas l'aspiration à partir du niveau négatif pour les pompes à aspiration d'extrémité et à boîtier divisé

**PRINCIPLE/PRINCIPIO/PRINCIPE**

- When pressure drops below the set value, jockey starts running with the signal from the pressure switch and continues running for 10 minutes till the system pressure reaches the set value. If the pressure continues drop, first the main pump starts to run. If the system pressure can't supply and pressure continues drop, the standby pump starts to run.
- Cuando la presión cae por debajo del valor, jockey comienza a funcionar con la señal del interruptor de presión y continúa funcionando durante 10 minutos hasta que la presión del sistema alcanza el valor establecido. Si la presión continúa bajando, primero la bomba principal comienza a funcionar. Si la presión del sistema no puede suministrar y la presión continúa bajando, la bomba de reserva comienza a funcionar.
- Lorsque la pression chute en dessous de la valeur, jockey commence à fonctionner avec le signal du pressostat et continue de fonctionner pendant 10 minutes jusqu'à ce que la pression du système atteigne la valeur définie. Si la pression continue de chuter, la pompe principale commence d'abord à fonctionner. Si la pression du système ne peut pas fournir et que la pression continue de chuter, la pompe de secours commence à fonctionner.

**MODEL CODE/CÓDIGO MODELO/CODE MODÈLE**

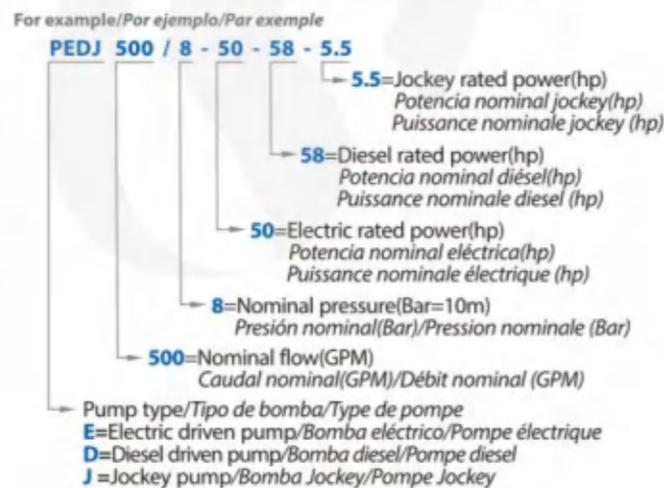

**NFPA 20 FIRE PUMP VERSIONS/VERSIONES DE LA BOMBA CONTRA INCENDIOS NFPA 20/VERSIONS DE POMPE À INCENDIE NFPA 20**

DESCRIPTION/DESCRIPCION/DESCRIPTION	PHOTO/FOTO/PHOTO
<p><b>PEJ Version:</b>                      Fire pump set consists of <b>Electric pump+Diesel pump+Jockey pump</b> and all accessories</p> <p><b>Versión PEJ:</b>                      Consiste en una bomba eléctrica + bomba diesel + bomba Jockey y todos los accesorios</p> <p><b>Versión PEJ:</b>                      L'ensemble de pompe à incendie comprend pompe électrique +pompe diesel +pompe Jockey et tous les accessoires</p>	
<p><b>PDJ Version:</b>                      Fire pump set consists of <b>Diesel pump+Jockey pump</b> and all accessories</p> <p><b>Versión PDJ:</b>                      Consiste en una bomba Diesel + bomba Jockey y todos los accesorios.</p> <p><b>Versión PDJ:</b>                      L'ensemble de pompe à incendie comprend pompe diesel + pompe Jockey et tous les accessoires.</p>	
<p><b>PEJ Version:</b>                      Fire pump set consists of <b>Electric pump+Jockey pump</b> and all accessories</p> <p><b>Versión PEJ:</b>                      Consiste en una bomba eléctrica + bomba Jockey y todos los accesorios</p> <p><b>Versión PEJ:</b>                      L'ensemble de pompe à incendie comprend pompe électrique +pompe Jockey et tous les accessoires</p>	
<p><b>PEEJ Version:</b>                      Fire pump set consists of <b>Electric pump+Electric pump+Jockey pump</b> and all accessories</p> <p><b>Versión PEEJ:</b>                      Consiste en una bomba eléctrica + bomba eléctrica + bomba Jockey y todos los accesorios</p> <p><b>Versión PEEJ:</b>                      L'ensemble de pompe à incendie comprend pompe électrique +pompe électrique + pompe Jockey et tous les accessoires</p>	

60Hz n=3500 r/min

60Hz n=3500 r/min

	Q	H	Electric/Electrico/Électrique		Diesel/Diésel/Diesel	Jockey/Jockey/Jockey	
			Option 1	Option 2	Coupling type Tipo acoplado Type d'accouplement	Option 1	Option 2
			Close coupled Coplado cerrado Couplage étroit	Separate coupled Acoplado separado Séparé couplé		Plastic impeller Impulsor plástico Roue plastique	SS304 impeller Impulsor inox304 Roue inox304
GPM	Bar						
PEDJ 50/6-5.5-8.6-2	50	6	P2C 32-200/40 5.5HP	PSM 32-250/55 7.5HP	PSD 32-250/55 8.6HP	PV 4x6/2HP	PVT(S) 1-9 1HP
PEDJ 50/7-7.5-10-2	50	7	P2C 40-210/55 7.5HP	PSM 32-250/75 10HP	PSD 32-250/75 10HP	PV 4x6/2HP	PVT(S) 1-9 1HP
PEDJ 50/8-10-12-3	50	8	P2C 40-210/75 10HP	PSM 32-250/110 15HP	PSD 32-250/110 12HP	PV 4x8/3HP	PVT(S) 1-11 1.5HP
PEDJ 50/9-10-27-3	50	9	P2C 40-210/75 10HP	PSM 32-250/150 20HP	PSD 32-250/150 27HP	PV 4x8/3HP	PVT(S) 1-11 1.5HP
PEDJ 100/7-10-10-2	100	6-7	PST 32-200/75 10HP	PSM 32-250/75 10HP	PSD 32-250/75 10HP	PV 4x6/2HP	PVT(S) 2-7 2HP
PEDJ 100/8-15-27-3	100	8	P2C 40-200/110 15HP	PSM 32-250/150 20HP	PSD 32-250/150 27HP	PV 4x8/3HP	PVT(S) 2-7 2HP
PEDJ 100/9-17.5-27-3	100	9	P2C 40-200/130 17.5HP	PSM 40-250/185 25HP	PSD 40-250/185 27HP	PV 4x8/3HP	PVT(S) 2-9 3HP
PEDJ 120/7-10-12-3	120	7	PST 32-200/75 10HP	PSM 32-250/75 10HP	PSD 32-250/75 12HP	PV 4x8/3HP	PVT(S) 2-7 2HP
PEDJ 150/7-15-12-3	150	7	PST 40-200/110 15HP	PSM 40-250/110 15HP	PSD 40-250/110 12HP	PV 4x8/3HP	PVT(S) 4-6 3HP
PEDJ 200/6-20-27-3	200	6	PST 50-200/150 20HP	PSM 50-250/150 20HP	PSD 50-250/150 27HP	PV 4x8/3HP	PVT(S) 4-6 3HP
PEDJ 200/7-25-27-3	200	7	PST 50-200/185 25HP	PSM 50-250/185 25HP	PSD 50-250/185 27HP	PV 4x8/3HP	PVT(S) 4-6 3HP
PEDJ 200/8-30-32-3	200	8	PST 50-200/220 30HP	PSM 50-250/220 30HP	PSD 50-250/220 32HP	PV 4x8/3HP	PVT(S) 4-8 4HP
PEDJ 200/9-40-38-4	200	9	-	PSM 50-250/300 40HP	PSD 50-250/300 38HP	PV 4x10/4HP	PVT(S) 4-8 4HP
PEDJ 200/10-50-58-5.5	200	10	-	PSM 50-250/370 50HP	PSD 50-315/370 58HP	PV 4x13/5.5HP	PVT(S) 4-10 5.5HP
PEDJ 250/7-25-27-3	250	7	PST 50-200/185 25HP	PSM 50-250/185 25HP	PSD 50-250/185 27HP	PV 6x7/3HP	PVT(S) 4-6 3HP
PEDJ 300/6-25-27-3	300	6	PST 50-200/185 25HP	PSM 50-250/185 25HP	PSD 50-250/185 27HP	PV 6x7/3HP	PVT(S) 8-5 4HP
PEDJ 300/7-30-32-4	300	7	PST 50-200/220 30HP	PSM 50-250/220 30HP	PSD 50-250/220 32HP	PV 6x9/4HP	PVT(S) 8-5 4HP
PEDJ 300/8-40-38-4	300	8	-	PSM 50-250/300 40HP	PSD 50-250/300 38HP	PV 6x9/4HP	PVT(S) 8-6 5.5HP
PEDJ 300/10-50-58-5.5	300	9-10	-	PSM 50-250/370 50HP	PSD 50-315/370 58HP	PV 6x12/5.5HP	PVT(S) 8-8 7.5HP
PEDJ 350/7-30-32-4	350	7	PST 50-200/220 30HP	PSM 50-250/220 30HP	PSD 50-250/220 32HP	PV 8x8/4HP	PVT(S) 8-5 4HP
PEDJ 400/6-30-32-4	400	6	PST 65-200/220 30HP	PSM 65-250/220 30HP	PSD 65-250/220 32HP	PV 8x8/4HP	PVT(S) 8-5 4HP
PEDJ 400/7-40-38-5.5	400	7	PST 65-200/300 40HP	PSM 65-250/300 40HP	PSD 65-250/300 38HP	PV 8x10/5.5HP	PVT(S) 8-6 5.5HP
PEDJ 400/8-50-58-5.5	400	8	PST 65-200/370 50HP	PSM 65-250/370 50HP	PSD 65-250/370 58HP	PV 8x10/5.5HP	PVT(S) 8-6 5.5HP
PEDJ 400/9-60-61-7.5	400	9	PST 65-250/450 60HP	PSM 65-315/450 60HP	PSD 65-315/450 61HP	PV 8x13/7.5HP	PVT(S) 8-8 7.5HP
PEDJ 500/7-40-38-5.5	500	6-7	PST 65-200/300 40HP	PSM 65-250/300 40HP	PSD 65-250/300 38HP	PV 12x7/5.5HP	PVT(S) 12-5 7.5HP
PEDJ 500/8-50-58-5.5	500	8	PST 65-200/370 50HP	PSM 65-250/370 50HP	PSD 65-250/370 58HP	PV 12x7/5.5HP	PVT(S) 12-5 7.5HP
PEDJ 500/9-60-61-7.5	500	9	PST 65-250/450 60HP	PSM 65-315/450 60HP	PSD 65-315/450 61HP	PV 12x9/7.5HP	PVT(S) 12-7 10HP
PEDJ 500/11-75-75-10	500	10-11	PST 65-250/550 75HP	PSM 65-315/550 75HP	PSD 65-315/550 75HP	PV 12x11/10HP	PVT(S) 12-7 10HP
PEDJ 500/13-100-100-10	500	12-13	PST 65-250/750 100HP	PSM 65-315/750 100HP	PSD 65-315/750 100HP	PV 12x11/10HP	PVT(S) 12-10 15HP

PDJ PEJ PEEJ also available/también disponible/aussi disponible

Other model can provide on request/Otro modelo disponible/Autre modèle disponible

	Q	H	Electric/Electrico/Électrique		Diesel/Diésel/Diesel	Jockey/Jockey/Jockey	
			Option 1	Option 2	Coupling type Tipo acoplado Type d'accouplement	Option 1	Option 2
			Close coupled Coplado cerrado Couplage étroit	Separate coupled Acoplado separado Séparé couplé		Plastic impeller Impulsor plástico Roue plastique	SS304 impeller Impulsor inox304 Roue inox304
GPM	Bar						
PEDJ 500/14-125-125-15	500	14	PST 65-250/900 125HP	PSM 65-315/900 125HP	PSD 65-315/900 125HP	PV 30x8/15HP	PVT(S) 12-10 15HP
PEDJ 750/7-60-61-10	750	6-7	PST 80-200/450 60HP	PSM 80-250/450 60HP	PSD 80-250/450 61HP	PV 12x11/10HP	PVT(S) 16-4 10HP
PEDJ 750/8-75-75-10	750	8	PST 80-200/550 75HP	PSM 80-250/550 75HP	PSD 80-250/550 75HP	PV 12x11/10HP	PVT(S) 16-6 15HP
PEDJ 750/9-100-100-10	750	9	-	PSM 80-250/750 100HP	PSD 80-250/750 100HP	PV 12x11/10HP	PVT(S) 16-6 15HP
PEDJ 750/11-100-100-12	750	10-11	PST 80-250/750 100HP	PSM 80-315/750 100HP	PSD 80-315/750 100HP	PV 30x6/12HP	PVT(S) 16-6 15HP
PEDJ 750/13-125-125-15	750	12-13	PST 80-250/900 125HP	PSM 80-315/900 125HP	PSD 80-315/900 125HP	PV 30x8/15HP	PVT(S) 16-8 20HP
PEDJ 750/14-150-150-15	750	14	-	PSM 80-315/1100 150HP	PSD 80-315/1100 150HP	PV 30x8/15HP	PVT(S) 16-8 20HP
PEDJ 1000/8-100-100-10	1000	8	PST 100-200/750 100HP	PSM 100-250/750 100HP	PSD 100-250/750 100HP	PV 30x5/10HP	PVT(S) 20-6 15HP
PEDJ 1000/9-125-125-12	1000	9	PST 100-200/900 125HP	PSM 100-250/900 125HP	PSD 100-250/900 125HP	PV 30x6/12HP	PVT(S) 20-6 15HP
PEDJ 1000/11-150-150-15	1000	10-11	PST 100-250/1100 150HP	PSM 100-315/1100 150HP	PSD 100-315/1100 150HP	PV 30x8/15HP	PVT(S) 20-6 15HP
PEDJ 1000/12-180-170-15	1000	12	PST 100-250/1320 180HP	PSM 100-315/1320 180HP	PSD 100-315/1320 170HP	PV 30x8/15HP	PVT(S) 20-8 20HP
PEDJ 1000/14-220-225-20	1000	13-14	PST 100-250/1600 220HP	PSM 100-315/1600 220HP	PSD 100-315/1600 225HP	-	PVT(S) 20-8 20HP
PEDJ 1250/8-150-150-12	1250	8	-	PSM 125-250/1100 150HP	PSD 125-250/1100 150HP	PV 30x6/12HP	PVT(S) 32-40-2 15HP
PEDJ 1250/9-180-170-12	1250	9	-	PSM 125-315/1320 180HP	PSD 125-315/1320 170HP	PV 30x6/12HP	PVT(S) 32-40 20HP
PEDJ 1250/11-220-225-15	1250	10-11	-	PSM 125-315/1600 220HP	PSD 125-315/1600 225HP	PV 30x8/15HP	PVT(S) 32-40 20HP
PEDJ 1250/12-250-270-25	1250	12	-	PSM 125-315/1850 250HP	PSD 125-315/1850 270HP	-	PVT(S) 32-60 25HP
PEDJ 1250/13-270-270-25	1250	13	-	PSM 125-315/2000 270HP	PSD 125-315/2000 270HP	-	PVT(S) 32-60 25HP
PEDJ 1500/8-180-170-15	1500	8	-	PSM 125-250H/1320 180HP	PSD 125-250H/1320 170HP	PV 30x8/15HP	PVT(S) 32-40-2 15HP
PEDJ 1500/9-180-170-15	1500	9	-	PSM 125-315/1320 180HP	PSD 125-315/1320 170HP	PV 30x8/15HP	PVT(S) 32-40 20HP
PEDJ 1500/10-220-225-20	1500	10	-	PSM 125-315/1600 220HP	PSD 125-315/1600 225HP	-	PVT(S) 32-50-2 20HP
PEDJ 1500/12-250-270-25	1500	11-12	-	PSM 125-315/1850 250HP	PSD 125-315/1850 270HP	-	PVT(S) 32-60 25HP
PEDJ 1500/13-270-270-25	1500	13	-	PSM 125-315/2000 270HP	PSD 125-315/2000 270HP	-	PVT(S) 32-60 25HP
PEDJ 2000/8-220-225-25	2000	8	-	PSM 150-250/1600 220HP	PSD 150-250/1600 225HP	-	PVT(S) 45-30 25HP
PEDJ 2000/9-270-270-25	2000	9	-	PSM 150-250/2000 270HP	PSD 150-250/2000 270HP	-	PVT(S) 45-30 25HP
PEDJ 2000/10-340-340-30	2000	10	-	PSM 150-315/2500 340HP	PSD 150-315/2500 340HP	-	PVT(S) 45-40-2 30HP
PEDJ 2000/13-430-410-40	2000	11-13	-	PSM 150-315/3150 430HP	PSD 150-315/3150 410HP	-	PVT(S) 45-40 40HP
PEDJ 2500/8-220-225-30	2500	8	-	PSM 150-250/1600 220HP	PSD 150-250/1600 225HP	-	PVT(S) 64-30-2 30HP
PEDJ 2500/9-270-270-40	2500	9	-	PSM 150-250/2000 270HP	PSD 150-250/2000 270HP	-	PVT(S) 64-30 40HP
PEDJ 2500/10-340-340-40	2500	10	-	PSM 150-315/2500 340HP	PSD 150-315/2500 340HP	-	PVT(S) 64-30 40HP
PEDJ 2500/12-430-410-50	2500	11-12	-	PSM 150-315/3150 430HP	PSD 150-315/3150 410HP	-	PVT(S) 64-40-2 50HP

PDJ PEJ PEEJ also available/también disponible/aussi disponible

Other model can provide on request/Otro modelo disponible/Autre modèle disponible



## MATERIAL DESCRIPTION/DESCRIPCIÓN DE MATERIAL/DESCRIPTION DU MATÉRIEL

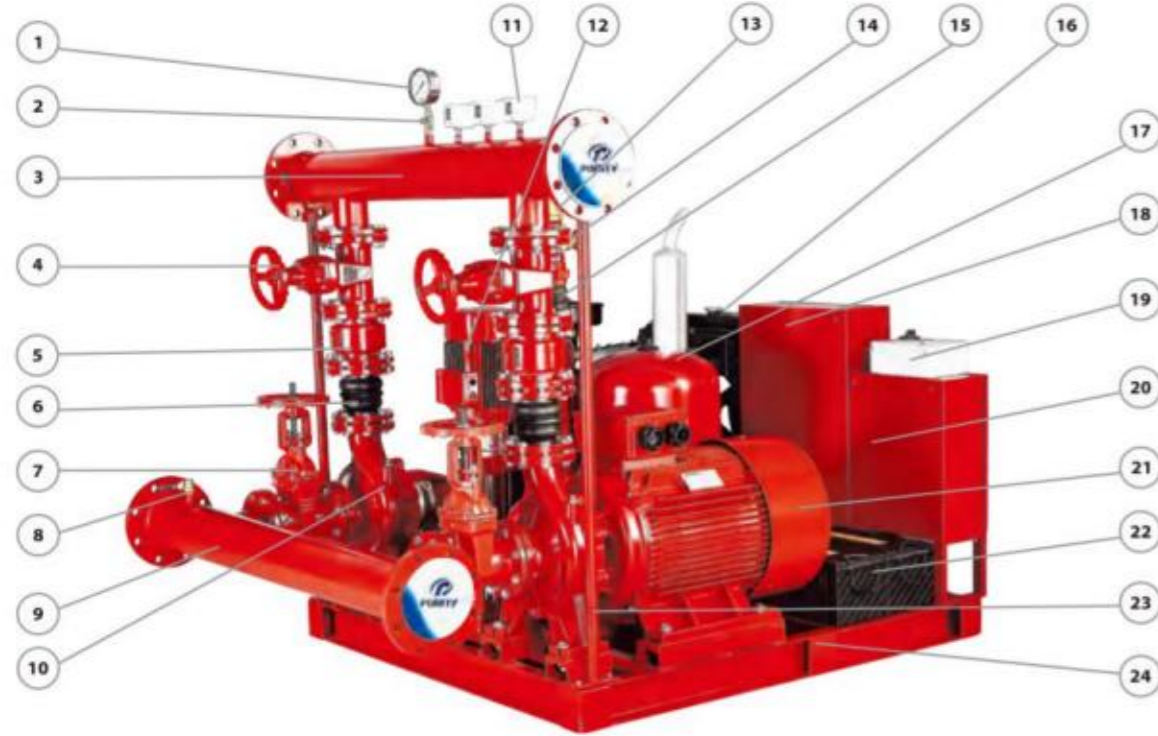

Pump Flow Rate Caudal de la bomba Débit de la pompe		Minimum Pipe Diameters (Nominal) Diámetros mínimos de tubería (nominal) Diamètres minimum de tuyau (nominal)	
GPM	m <sup>3</sup> /h	Suction Succión Succion	Discharge Descarga Décharge
25	6	1"-DN25	1"-DN25
50	11	1 ½"-DN40	1 ¼"-DN32
100	23	2"-DN50	2"-DN50
150	34	2 ½"-DN65	2 ½"-DN65
200	45	3"-DN80	3"-DN80
250	57	4"-DN100	3"-DN80
300	68	4"-DN100	4"-DN100
400	91	4"-DN100	4"-DN100
450	102	5"-DN125	5"-DN125
500	114	5"-DN125	5"-DN125

Pump Flow Rate Caudal de la bomba Débit de la pompe		Minimum Pipe Diameters (Nominal) Diámetros mínimos de tubería (nominal) Diamètres minimum de tuyau (nominal)	
GPM	m <sup>3</sup> /h	Suction Succión Succion	Discharge Descarga Décharge
750	170	6"-DN150	6"-DN150
1000	227	8"-DN200	6"-DN150
1250	284	8"-DN200	8"-DN200
1500	341	8"-DN200	8"-DN200
2000	455	10"-DN250	10"-DN250
2500	568	10"-DN250	10"-DN250
3000	682	12"-DN300	12"-DN300
3500	795	12"-DN300	12"-DN300
4000	909	14"-DN350	12"-DN300
4500	1023	16"-DN400	14"-DN350
5000	1136	16"-DN400	14"-DN350

No.	Description Descripción Description	Material Material Matériel	No.	Description Descripción Description	Material Material Matériel	No.	Description Descripción Description	Material Material Matériel
1	Pressure Gauge Manómetro Manomètre	0-16bar 0-16bar 0-16bar	9	Suction pipeline Tubería de succión Canalisation d'aspiration	Carbon steel Acero carbono Acier Carbone	17	Pressure tank Tanque de presión Réservoir de pression	Iron/EPDM membrane Hierro/Membrana EPDM Fer-Membrane EPDM
2	Relief Valve Válvula de alivio Soupape de décharge	Brass Latón Laiton	10	Diesel pump Bomba diesel Pompe diesel	Standby supplier Proveedor en espera Fournisseur de secours	18	Electric controller Controladora eléctrica Contrôleur électrique	DOL/Star-delta DOL/Star-delta DOL/étoile-delta
3	Discharge pipeline Tubería de descarga Canalisation de décharge	Carbon steel Acero carbono Acier Carbone	11	Pressure Switch Interruptor presión Pressostat	0-16bar 0-16bar 0-16bar	19	Jockey controller Controladora jockey Contrôleur Jockey	DOL DOL DOL
4	Gate Valve Válvula compuerta Robinet-vanne	Ductile Iron Hierro dúctil Fonte ductile	12	Jockey pump Bomba jockey Pompe jockey	Maintain supplier Mantener proveedor Maintenir le fournisseur	20	Diesel controller Controladora diesel Contrôleur diesel	DOL DOL DOL
5	Check Valve La válvula de retención Clapet anti-retour	Ductile Iron Hierro dúctil Fonte ductile	13	Jockey Check Valve Válvula de retención jockey Clapet anti-retour jockey	Brass Latón Laiton	21	Electric pump Bomba eléctrica Pompe électrique	Main supplier Proveedor principal Fournisseur principal
6	Flexible Joint Articulación flexible Joint flexible	Rubber Caucho Caoutchouc	14	Jockey Gate Valve Válvula de compuerta jockey Robinet-vanne jockey	Brass Latón Laiton	22	Batteries Pilas Piles	Main/Standby Principal/En espera Principal/Veille
7	OS&Y valve Válvula OS&Y Vanne OS&Y	Ductile Iron Hierro dúctil Fonte ductile	15	Flexible Joint Articulación flexible Joint flexible	Rubber Caucho Caoutchouc	23	Support rod Barra de soporte Tige de support	Iron Hierro Le fer
8	Relief Valve Válvula de seguridad Soupape de décharge	Brass Latón Laiton	16	Diesel engine Motor diesel Moteur diesel	Internal combustion Combustión interna Combustion interne	24	Base Base Base	Iron Hierro Le fer

## SCHEMATIC DIAGRAM OF FIRE PUMP/DIAGRAMA SCHMATIC DE BOMBA CONTRA INCENDIOS/SCHÉMA SCHMATIQUE DE POMPE À INCENDIE

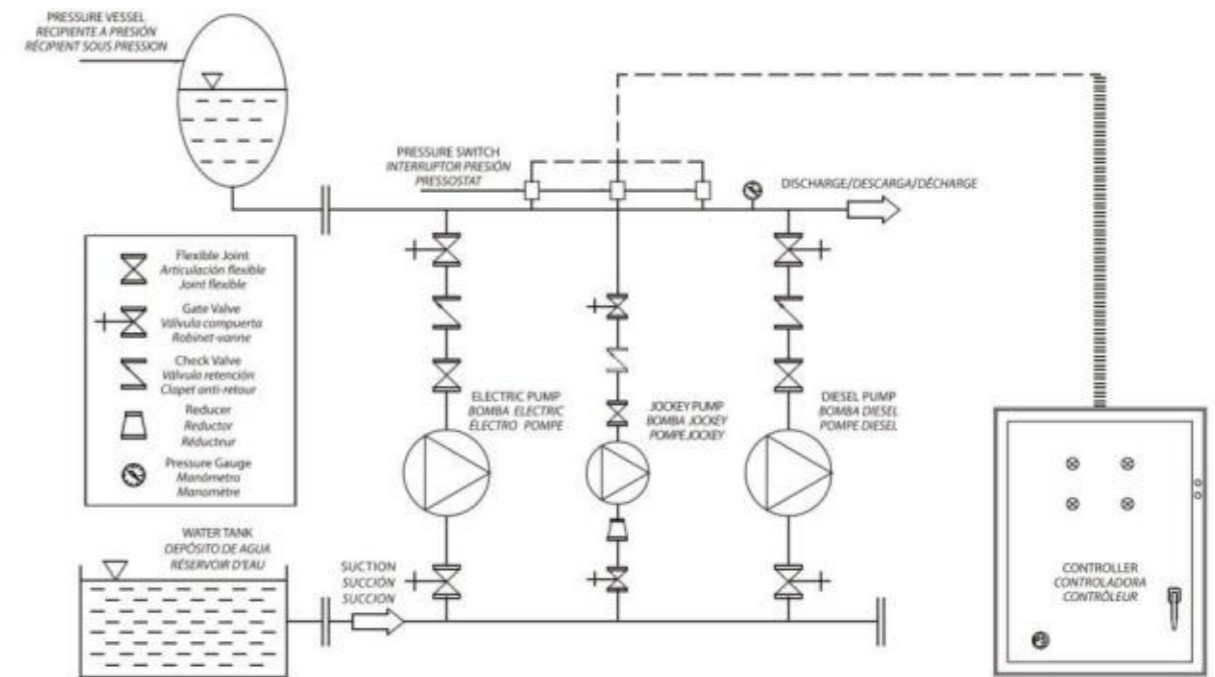

**TECHNICAL SHEET/HOJA TÉCNICA/FICHE TECHNIQUE**

Model/Modelo/Modèle	PST	
Capacity/Caudal/Débit	0-400	m <sup>3</sup> /h
Head/Altura/Hauteur	0-151	m
DN	32-125	mm
Speed/Velocidad/Vitesse	3500	rpm
T max	120	°C
Power/Potencia/Puiss.	0.75-160	kW
Voltage/Voltaje/Tension	220/380/400/440	V
HZ	60	
Class/Clase/Classe	Class F/IP 55	
Duty/Servicio/Devoir	S1 continuous	
Casing/Cuerpo/Corps	Grey Cast iron Hierro fundido gris Fonte grise	
Impeller/Impulsor/Roue	AISI 304/Brass Inox304/Bronce Inox304/Laiton	
Shaft/Eje/Arbre	AISI304 Inox304 Inox304	
Shaft seal/Sello/Scellé	Mechanical Seal Sello mecánico Garniture mécanique	
Bearing/Rodamiento/Palier	Grease lubrication rolling bearing Rodamientos lubricación con grasa Roulement lubrification à la graisse	

**Electric/Electrico/Électrique**

- Electric pump to primarily provide flow and pressure in the system
- Bomba eléctrica para proporcionar principalmente flujo y presión
- Pompe électrique pour fournir principalement le débit et la pression



Close coupled type  
Tipo acoplado cerrado  
Type à couplage étroit

**NEW/NUEVO/NOUVEAU**

**DESCRIPTION/DESCRIPCIONES/DESCRIPTION**

- According to NFPA20, centrifugal pump shall be of the overhung impeller design with close or separate coupled end suction type
- Pump capacities are based on the calculated system demand
- Fire pump shutoff head should not exceed 140% of the nominal value
- Recommended the maximum system demand flow correlate to a point on pump curve between 90% to 140% of the pump capacity
- De acuerdo con NFPA20, bomba centrífuga debe ser del diseño impulsor sobresaliente con tipo succión extremo acoplado cerrado o separado
- Las capacidades de la bomba se basan en la demanda calculada del sistema
- El cabezal de cierre de la bomba contra incendios no debe exceder el 140% del valor nominal
- Se recomienda que el flujo máximo de demanda se correlacione con un punto en la curva entre 90% y 140% de la capacidad nominal
- Selon NFPA20, pompe centrifuge doit être du type à roue surplombée avec type d'aspiration à extrémité couplée étroite ou séparée
- Les capacités de la pompe sont basées sur la demande calculée du système
- La tête d'arrêt de la pompe à incendie ne doit pas dépasser 140% de la valeur nominale
- Il est recommandé que le débit maximal de demande soit corrélé à un point sur la courbe entre 90% et 140% de la capacité nominale

**MODEL CODE/CÓDIGO MODELO/CODE MODÈLE**

For example/ Por ejemplo/ Par exemple

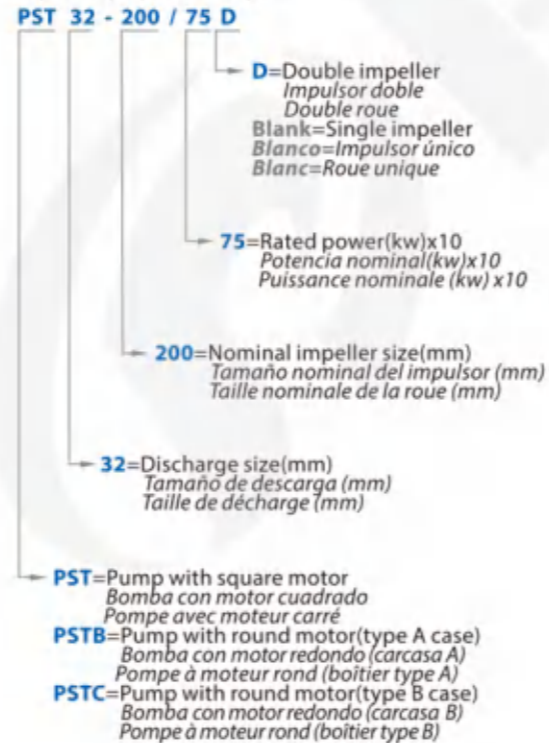

60Hz n=3500 r/min

MODEL MODELO MODÈLE	DN mm	Power Potencia Puissance		Q=DELIVERY/CAUDAL/DÉBIT																
		kw	hp	us gpm l/min m <sup>3</sup> /h	0	25	50	75	100	120	150	200	250	300	350	400	450	500	600	
PST 32-250/55	50x32	5.5	7.5	60	59.5	58	54	50	46	-	-	-	-	-	-	-	-	-	-	-
PST 32-250/75	50x32	7.5	10	75	74.5	74	72.5	70	67.3	62	-	-	-	-	-	-	-	-	-	-
PST 32-250/92	50x32	9.2	12.5	79	78.5	78	76.5	73.5	71.3	64.5	-	-	-	-	-	-	-	-	-	-
PST 32-250/110	50x32	11	15	90	88	84.3	80	76	72	66	-	-	-	-	-	-	-	-	-	-
PST 32-250/150	50x32	15	20	97	95	91.5	87.2	83	79	73.5	-	-	-	-	-	-	-	-	-	-
PST 32-250/55D	50x32	5.5	7.5	79.5	77	73	67	58	42	-	-	-	-	-	-	-	-	-	-	-
PST 32-250/75D	50x32	7.5	10	95	93	89	84	78	70	46	-	-	-	-	-	-	-	-	-	-
PST 40-250/92	65x40	9.2	12.5	64	-	-	60	57	55	51	42	-	-	-	-	-	-	-	-	-
PST 40-250/110	65x40	11	15	78	-	-	75.5	74	72	69	59	38	-	-	-	-	-	-	-	-
PST 40-250/150	65x40	15	20	88.5	-	-	83.5	81.5	79	76	67	47	-	-	-	-	-	-	-	-
PST 40-250/185	65x40	18.5	25	94	-	-	89	87	84.5	81.5	73	51	-	-	-	-	-	-	-	-
PST 50-250/150	65x50	15	20	68.5	-	-	-	-	-	65	62	58	53	45	-	-	-	-	-	-
PST 50-250/185	65x50	18.5	25	79	-	-	-	-	-	77	74	71	66	59	47	-	-	-	-	-
PST 50-250/220	65x50	22	30	89.5	-	-	-	-	-	88	85	81.5	76	68	57	-	-	-	-	-
PST 65-250/220	80x65	22	30	64.8	-	-	-	-	-	-	-	63.5	62	61	58.5	56	52.5	-	-	-
PST 65-250/300	80x65	30	40	80	-	-	-	-	-	-	-	79	78	77	74.5	72	70	59	-	-
PST 65-250/370	80x65	37	50	92	-	-	-	-	-	-	-	89.5	88.5	87	85	83	80	69	-	-

MODEL MODELO MODÈLE	DN mm	Power Potencia Puissance		Q=DELIVERY/CAUDAL/DÉBIT															
		kw	hp	us gpm l/min m <sup>3</sup> /h	0	250	400	500	600	750	850	950	1000	1250	1350	1500	1750		
PST 65-315/450	80x65	45	60	102	98	94.5	90	83	-	-	-	-	-	-	-	-	-	-	-
PST 65-315/550	80x65	55	75	122	120	114.5	111	104	85	-	-	-	-	-	-	-	-	-	-
PST 65-315/750	80x65	75	100	141	141	134.5	132	123	105	86	64	-	-	-	-	-	-	-	-
PST 65-315/900	80x65	90	125	151	150	144.5	141	133	115	95	74	-	-	-	-	-	-	-	-
PST 80-250/370	100x80	37	50	71.5	70.9	70.5	66	62	54	46	37	-	-	-	-	-	-	-	-
PST 80-250/450	100x80	45	60	88	86.7	86	84	80	72	62	49	-	-	-	-	-	-	-	-
PST 80-250/550	100x80	55	75	94.5	94.5	94.5	92	89	82	76	66	-	-	-	-	-	-	-	-
PST 80-315/450	100x80	45	60	85	84	82.6	82	78	72	64	52	-	-	-	-	-	-	-	-
PST 80-315/550	100x80	55	75	98	97	95.6	95	92	86	78	67	-	-	-	-	-	-	-	-
PST 80-315/750	100x80	75	100	124	123	121.6	119	116	110	103	94.5	89	-	-	-	-	-	-	-
PST 80-315/900	100x80	90	125	144	143	141.6	140	137	130	122	114	108	-	-	-	-	-	-	-
PST 100-250/450	125x100	45	60	65	65	64	63	62	58.5	56	53	51	39	33.5	-	-	-	-	-
PST 100-250/550	125x100	55	75	77	76	75.5	76	75	73	72	70	70	62.3	59	-	-	-	-	-
PST 100-250/750	125x100	75	100	91	91	90.5	89.7	88	86	84	82	81	71.7	68.5	56	-	-	-	-
PST 100-250/900	125x100	90	125	100	100	99.5	98	97	95	93	91	90	80.7	77.5	65	-	-	-	-
PST 100-315/750	125x100	75	100	80	-	-	78	78	76	74	73	72	66	64	56	-	-	-	-
PST 100-315/900	125x100	90	125	100	-	-	98	98	96	94	93	92	86	84	77	-	-	-	-
PST 100-315/1100	125x100	110	150	118	-	-	116	115.5	114	112	111	110	104	102	95	-	-	-	-
PST 100-315/1320	125x100	132	180	129	-	-	127	126	124	123	122	121	115	112	105	-	-	-	-
PST 100-315/1600	125x100	160	220	148	-	-	146	145	144	142	141	140	134	132	125	-	-	-	-
PST 125-250/550	150x125	55	75	70	-	-	67	66.5	65	63.5	61.5	60.5	54	50.5	-	-	-	-	-
PST 125-250/750	150x125	75	100	80	-	-	77	76	74.5	73	72	71	67	65	60	-	-	-	-
PST 125-250/900	150x125	90	125	87	-	-	84	83	81.5	80	78.5	78	73.5	71.5	67.5	60	-	-	-



TECHNICAL SHEET/HOJA TÉCNICA/FICHE TECHNIQUE

Model/Modelo/Modèle	PSD
Capacity/Caudal/Débit	0-1000 m <sup>3</sup> /h
Head/Altura/Hauteur	0-164 m
DN	32-150 mm
Speed/Velocidad/Vitesse	3000 rpm
T max	120 °C
Power/Potencia/Puiss.	6.3-300 kW
Casing/Cuerpo/Corps	Grey cast iron Hierro fundido gris Fonte grise
Impeller/Impulsor/Roue	AISI 304/Brass Inox304/Bronce Inox 304/Laiton
Shaft/Eje/Arbre	AISI 304 Inox304 Inox304
Shaft seal/Sello/Scellé	Mechanical Seal Sello mecánico Garniture mécanique
Bearing/Rodamiento/Palier	Grease lubrication rolling bearing Rodamientos lubricación con grasa Roulement lubrification à la graisse

**Diesel/Diésel/Diesel**

- 🇬🇧 Diesel pump as standby provider flow and pressure in the system
- 🇪🇸 Bomba diesel como proveedor de reserva de flujo y presión
- 🇫🇷 Pompe diesel comme débit et pression du fournisseur de secours



NEW/NUEVO/NOUVEAU

DESCRIPTION/DESCRIPCIONES/DESCRIPTION

- 🇬🇧 Diesel engines have proven to be very reliable and effective for driving fire pumps
- Diesel engines are currently the only type of internal combustion engine permitted by NFPA 20
- Each engine shall be provided with two storage battery units according to NFPA20
- Diesel engines for fire pump is of the compression ignition type
- Advanced direct injection and combustion system.
- 🇪🇸 Los motores diesel han demostrado ser muy confiables y efectivos para conducir bombas contra incendios
- Los motores diesel son actualmente el único tipo de motor de combustión interna permitido por NFPA 20
- Cada motor debe contar con dos unidades de batería de almacenamiento de acuerdo con NFPA20
- Los motores diesel para el accionamiento de la bomba contra incendios son del tipo de encendido por compresión
- Sistema avanzado de inyección directa y combustión
- 🇫🇷 Les moteurs diesel se sont révélés très fiables et efficaces pour entraîner des pompes à incendie
- Les moteurs diesel sont actuellement le seul type de moteur à combustion interne autorisé par la NFPA 20
- Chaque moteur doit être équipé de deux batteries d'accumulateurs selon NFPA20
- Les moteurs diesel pour l'entraînement des pompes à incendie sont du type à allumage par compression
- Système avancé d'injection directe et de combustion

MODEL CODE/CÓDIGO MODELO/CODE MODÈLE

For example/ Por ejemplo/ Par exemple

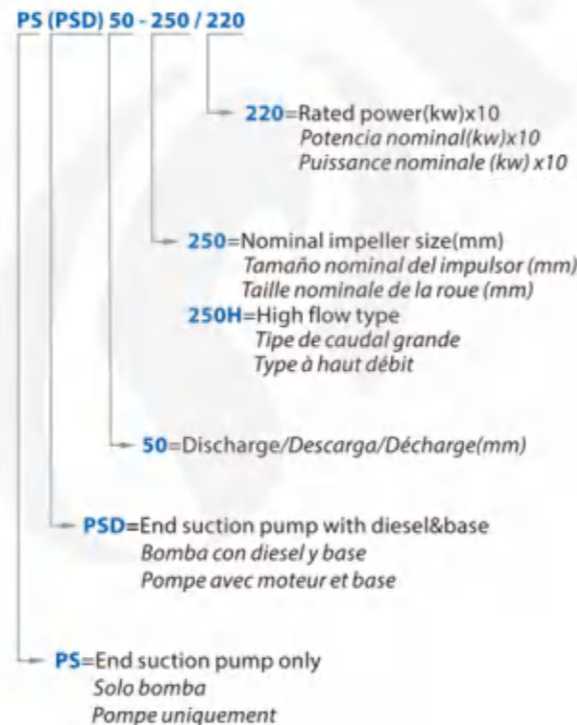

TECHNICAL DATA/DATOS TÉCNICOS/DONNÉES TECHNIQUES

50Hz n=3000 r/min

MODEL MODELO MODÈLE	DN mm	Impr dia. mm	Power Potencia Puissance kw hp	Q=DELIVERY/CAUDAL/DÉBIT																
				0	25	50	75	100	120	150	200	250	300	350	400	450	500	600		
PSD 32-250/55	50x32	208	6.3 8.6	60	59.5	58	54	50	46	-	-	-	-	-	-	-	-	-	-	-
PSD 32-250/75	50x32	230	7.2 10	75	74.5	74	72.5	70	67.3	62	-	-	-	-	-	-	-	-	-	-
PSD 32-250/92	50x32	237	8.2 12	79	78.5	78	76.5	73.5	71.3	64.5	-	-	-	-	-	-	-	-	-	-
PSD 32-250/110	50x32	250	8.2 12	90	88	84.3	80	76	72	66	-	-	-	-	-	-	-	-	-	-
PSD 32-250/150	50x32	258	20 27	97	95	91.5	87.2	83	79	73.5	-	-	-	-	-	-	-	-	-	-
PSD 40-250/110	65x40	230	8.2 12	78	-	-	75.5	74	72	69	59	38	-	-	-	-	-	-	-	-
PSD 40-250/150	65x40	250	20 27	88.5	-	-	83.5	81.5	79	76	67	47	-	-	-	-	-	-	-	-
PSD 40-250/185	65x40	258	20 27	94	-	-	89	87	84.5	81.5	73	51	-	-	-	-	-	-	-	-
PSD 40-315/185	65x40	260	20 27	95	-	-	95	94	92.5	88	74	-	-	-	-	-	-	-	-	-
PSD 40-315/220	65x40	275	24 32	106	-	-	105	104	103.5	99	86	-	-	-	-	-	-	-	-	-
PSD 40-315/300	65x40	290	28 38	120	-	-	120	119	117	116	108	-	-	-	-	-	-	-	-	-
PSD 40-315/370	65x40	322	42 58	144	-	-	144	143	142	139	134	-	-	-	-	-	-	-	-	-
PSD 40-315/450	65x40	340	45 61	160	-	-	160	160	159	158	154	-	-	-	-	-	-	-	-	-
PSD 50-250/150	65x50	228	20 27	68.5	-	-	-	-	-	65	62	58	53	45	-	-	-	-	-	-
PSD 50-250/185	65x50	235	20 27	79	-	-	-	-	-	77	74	71	66	59	47	-	-	-	-	-
PSD 50-250/220	65x50	250	24 32	89.5	-	-	-	-	-	88	85	81.5	76	68	57	-	-	-	-	-
PSD 50-250/300	65x50	258	28 38	95.5	-	-	-	-	-	92	90	87	81	74	63	-	-	-	-	-
PSD 50-315/370	65x50	284	42 58	114	-	-	-	-	-	111	108	104	98	92	84	-	-	-	-	-
PSD 50-315/450	65x50	306	45 61	132	-	-	-	-	-	129	125.5	122	117	110	102	-	-	-	-	-
PSD 50-315/550	65x50	322	55 75	146	-	-	-	-	-	143	140	136	132	125	116	-	-	-	-	-
PSD 50-315/750	65x50	340	75 100	164	-	-	-	-	-	162	158	154	148	141	134	-	-	-	-	-
PSD 65-250/220	80x65	225	24 32	64.8	-	-	-	-	-	-	-	63.5	62	61	58.5	56	52.5	-	-	-
PSD 65-250/300	80x65	244	28 38	80	-	-	-	-	-	-	-	79	78	77	74.5	72	70	59	-	-
PSD 65-250/370	80x65	258	42 58	92	-	-	-	-	-	-	-	89.5	88.5	87	85	83	80	69	-	-

MODEL MODELO MODÈLE	DN mm	Impr dia. mm	Power Potencia Puissance kw hp	Q=DELIVERY/CAUDAL/DÉBIT																				
				0	250	400	500	600	750	850	950	1000	1250	1350	1500	1750	2000	2500	3000	3500	4500			
PSD 65-315/450	80x65	262	45 61	102	98	94.5	90	83	-	-	-	-	-	-	-	-	-	-	-	-	-			
PSD 65-315/550	80x65	290	55 75	122	120	114.5	111	104	85	-	-	-	-	-	-	-	-	-	-	-	-			
PSD 65-315/750	80x65	317	75 100	141	141	134.5	132	123	105	86	64	-	-	-	-	-	-	-	-	-	-			
PSD 65-315/900	80x65	328	90 125	151	150	144.5	141	133	115	95	74	-	-	-	-	-	-	-	-	-	-			
PSD 80-250/450	100x80	240	45 61	88	86.7	86	84	80	72	62	49	-	-	-	-	-	-	-	-	-	-			
PSD 80-250/550	100x80	258	55 75	94.5	94.5	94.5	92	89	82	76	66	-	-	-	-	-	-	-	-	-	-			
PSD 80-250/750	100x80	276	75 100	108.5	108.5	108.5	106	103	96.5	90	80	-	-	-	-	-	-	-	-	-	-			
PSD 80-315/550	100x80	270	55 75	98	97	95.6	95	92	86	78	67	-	-	-	-	-	-	-	-	-	-			
PSD 80-315/750	100x80	295	75 100	124	123	121.6	119	116	110	103	94.5	89	-	-	-	-	-	-	-	-	-			
PSD 80-315/900	100x80	320	90 125	144	143	141.6	140	137	130	122	114	108	-	-	-	-	-	-	-	-	-			
PSD 80-315/1100	100x80	328	110 150	153	152	150.6	149	146	140	132	123	118	-	-	-	-	-	-	-	-	-			
PSD 100-250/550	125x100	240	55 75	77	76	75.5	76	75	73	72	70	70	62.3	59	-	-	-	-	-	-	-			
PSD 100-250/750	125x100	257	75 100	91	91	90.5	89.7	88	86	84	82	81	71.7	68.5	56	-	-	-	-	-	-			
PSD 100-250/900	125x100	270	90 125	100	100	99.5	98	97	95	93	91	90	80.7	77.5	65	-	-	-	-	-	-			
PSD 100-315/1100	125x100	300	110 150	118	-	-	116	115.5	114	112	111	110	104	102	95	-	-	-	-	-	-			
PSD 100-315/1320	125x100	315	125 170	129	-	-	127	126	124	123	122	121	115	112	105	-	-	-	-	-	-			
PSD 100-315/1600	125x100	328	165 225	148	-	-	146	145	144	142	141	140	134	132	125	-	-	-	-	-	-			
PSD 125-250/750	150x125	255	75 100	80	-	-	77	76	74.5	73	72	71	67	65	60	-	-	-	-	-	-			
PSD 125-250/900	150x125	265	90 125	87	-	-	84	83	81.5	80	78.5	78	73.5	71.5	67.5	60	-	-	-	-	-			
PSD 125-250/1100	150x125	274	110 150	97	-	-	94	93	92	90.5	89	88	84	83.5	78.5	71	-	-	-	-	-			
PSD 125-250H/1100	150x125	240	110 150	74	-	-	74.5	74	74	73	73	72.5	70.8	70.4	69	66	62.5	53	-	-	-			
PSD 125-250H/1320	150x125	260	125 170	84	-	-	84	84	83.5	83	82.5	82	80.8	80.4	78.5	76	72	63	-	-	-			
PSD 125-250H/1600	150x125	280	165 225	98	-	-	97.5	97.5	97.5	97	97	96.5	94.8	94.4	93	90	87	78	66	-	-			
PSD 125-315/1320	150x125	280	125 170	96	-	-	-	-	-	-	96	96	94	93.5	92	88.5	84	65	-	-	-			
PSD 125-315/1600	150x125	295	165 225	106	-	-	-	-	-	-	105.5	105	104	103.5	102	100	96	82	-	-	-			
PSD 125-315/1850	150x125	310	200 270	122	-	-	-	-	-	-	122	121.7	120	119.5	118.5	116	110	95	-	-	-			
PSD 125-315/2000	150x125	328	200 270	136	-	-	-	-	-	-	136	135.5	135	133.5	133	130	125	110	-	-	-			
PSD 150-250/1320	200x150	265	125 170	80.2	-	-	-	-	-	-	-	-	-	78	75	73.5	71	67	61	54	37			
PSD 150-250/1600	200x150	280	165 225	90	-	-	-	-	-	-	-	-	-	88	87	85	84	79	74	66	47			
PSD 150-250/2000	200x150	295	200 270	100	-	-	-	-	-	-	-	-	-	97	96	95	93	89	84	76	56			
PSD 150-315/1850	200x150	287	200 270	92	-	-	-	-	-	-	-	-	-	90	89	87.2	85	80	71	61	-			
PSD 150-315/2500	200x150	305	250 340	111	-	-	-	-	-	-	-	-	-	110	108	106	104	98	90	82	62			
PSD 150-315/2800	200x150	315	300 410	124	-	-	-	-	-	-	-	-	-	121	120	118	116	111	104	95	73			
PSD 150-315/3150	200x150	327	300 410	135	-	-	-	-	-	-	-	-	-	134	133	132	130	124	116	107	84			

## TECHNICAL SHEET/HOJA TÉCNICA/FICHE TECHNIQUE

Model/Modelo/Modèle	PSD-L	
Capacity/Caudal/Débit	0-400	m <sup>3</sup> /h
Head/Altura/Hauteur	0-114	m
DN	40-125	mm
Speed/Velocidad/Vitesse	2500/2300	rpm
T max	120	°C
Power/Potencia/Puiss.	20-118	kW
Casing/Cuerpo/Corps	Grey cast iron Hierro fundido gris Fonte grise	
Impeller/Impulsor/Roue	AISI 304/Brass Inox304/Bronce Inox 304/Laiton	
Shaft/Eje/Arbre	AISI 304 Inox304 Inox304	
Shaft seal/Sello/Scellé	Mechanical Seal Sello mecánico Garniture mécanique	
Bearing/Rodamiento/Palier	Grease lubrication rolling bearing Rodamientos lubricación con grasa Roulement lubrification à la graisse	

**Diesel/Diesel/Diesel**

Diesel pump as standby provider flow and pressure in the system

Bomba diesel como proveedor de reserva de flujo y presión

Pompe diesel comme débit et pression du fournisseur de secours

**NEW/NUEVO/NOUVEAU**
**DESCRIPTION/DESCRIPCIONES/DESCRIPTION**

- Air-cooled 2-to 6-cylinder naturally aspirated in-line engines.
- Advanced direct injection and combustion system.
- Enormous traction through high torque backup.
- Extremely compact dimensions.
- Noise-optimized technology.
- Motores en línea de 2 a 6 cilindros refrigerados por aire.
- Sistema avanzado de inyección directa y combustión.
- Enorme tracción a través del respaldo de alto torque.
- Dimensiones extremadamente compactas.
- La tecnología de ruido optimizado.
- Moteurs en ligne à aspiration naturelle de 2 à 6 cylindres refroidis par air.
- Système avancé d'injection directe et de combustion.
- Traction énorme grâce à un couple élevé.
- Dimensions extrêmement compactes.
- Technologie optimisée pour le bruit.

**MODEL CODE/CÓDIGO MODELO/COE MODÈLE**

For example/Por ejemplo/Par exemple

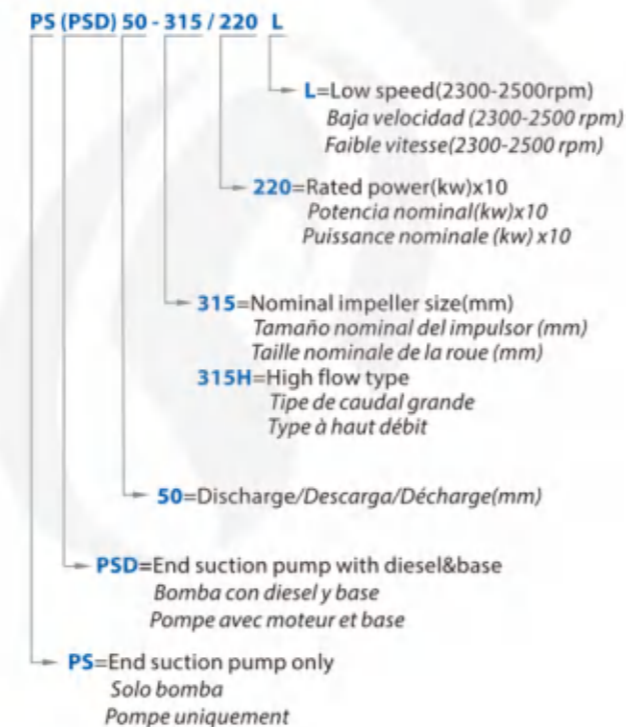
**TECHNICAL DATA/DATOS TÉCNICOS/DONNÉES TECHNIQUES**

50Hz n=2500/2300 r/min

MODEL MODELO MODÈLE	DN mm	Implr dia. 2500 rpm mm	2300 rpm mm	Power Potencia Puissance 2500 rpm kw	2300 rpm kw	Q=DELIVERY/CAUDAL/DÉBIT																											
						m <sup>3</sup> /h																											
						H=Head/Altura/Hauteur(m)																											
PSD 40-315/92L	65x40	269	292	21	20	64	59	55	49.5	45	39.8	-	-	-	-	-	-	-	-	-	-	-	-	-	-	-	-	-	-	-	-	-	
PSD 40-315/110L	65x40	276	300	21	20	72	67.5	63.5	57.5	52.2	47	-	-	-	-	-	-	-	-	-	-	-	-	-	-	-	-	-	-	-	-	-	
PSD 40-315/150L	65x40	300	326	21	20	84.5	79.3	75.2	70	66	61	-	-	-	-	-	-	-	-	-	-	-	-	-	-	-	-	-	-	-	-	-	
PSD 40-315/185L	65x40	312	339	21	20	95	95	92.5	87	81	75	-	-	-	-	-	-	-	-	-	-	-	-	-	-	-	-	-	-	-	-	-	
PSD 40-315/220L	65x40	330	-	21	20	106	106	103.5	98	92	85	-	-	-	-	-	-	-	-	-	-	-	-	-	-	-	-	-	-	-	-	-	
PSD 50-315/150L	65x50	274	297	21	20	68.5	-	-	64	63	61.5	57	50	39	-	-	-	-	-	-	-	-	-	-	-	-	-	-	-	-	-	-	
PSD 50-315/185L	65x50	282	307	21	20	79	-	-	75.8	74.8	74	70	63.5	47	-	-	-	-	-	-	-	-	-	-	-	-	-	-	-	-	-	-	-
PSD 50-315/220L	65x50	300	326	21	20	89.5	-	-	86	85.3	84	80	73.5	57	-	-	-	-	-	-	-	-	-	-	-	-	-	-	-	-	-	-	
PSD 50-315/300L	65x50	310	337	38	36	95.5	-	-	92	91.3	90	85	79.5	63	-	-	-	-	-	-	-	-	-	-	-	-	-	-	-	-	-	-	
PSD 50-315/370L	65x50	340	-	38	36	114	-	-	111	109	107.5	103	97	84	-	-	-	-	-	-	-	-	-	-	-	-	-	-	-	-	-	-	
PSD 65-315/220L	80x65	270	293	21	20	64.8	-	-	-	64.7	63	62	58.5	56.5	50	-	-	-	-	-	-	-	-	-	-	-	-	-	-	-	-	-	-
PSD 65-315/300L	80x65	293	318	38	36	80	-	-	-	79.8	79	77.5	74.5	72.5	66	55	-	-	-	-	-	-	-	-	-	-	-	-	-	-	-	-	-
PSD 65-315/370L	80x65	310	328	38	36	92	-	-	-	91	89	88.5	85	83	78	65	-	-	-	-	-	-	-	-	-	-	-	-	-	-	-	-	-
PSD 65-315/450L	80x65	314	-	51	46	102	-	-	-	100	98	97	94.5	93	90	78	-	-	-	-	-	-	-	-	-	-	-	-	-	-	-	-	-
PSD 80-315/370L	100x80	271	295	38	36	71.5	-	-	-	-	70.9	70.7	70.5	68	65.5	59	51	38.5	-	-	-	-	-	-	-	-	-	-	-	-	-	-	-
PSD 80-315/450L	100x80	288	313	51	46	88	-	-	-	-	86.7	86.4	86	85.6	83.6	78	70.5	51	-	-	-	-	-	-	-	-	-	-	-	-	-	-	-
PSD 80-315/550L	100x80	310	328	56	50	94.5	-	-	-	-	94.5	94.5	94.5	93.2	91.8	87	79.5	68.3	-	-	-	-	-	-	-	-	-	-	-	-	-	-	-
PSD 80-315/750L	100x80	328	-	78	74	108.5	-	-	-	-	108.5	108.5	108.5	108	105.8	101	93.5	82.3	-	-	-	-	-	-	-	-	-	-	-	-	-	-	-
PSD 100-315/450L	125x100	264	287	51	46	65	-	-	-	-	65	64.5	64	63.8	63	60.5	58	55	50	39	33.5	-	-	-	-	-	-	-	-	-	-	-	-
PSD 100-315/550L	125x100	288	313	56	50	77	-	-	-	-	76	75.8	75.5	75.5	75	73.8	72	71.5	69	62.3	59	-	-	-	-	-	-	-	-	-	-	-	-
PSD 100-315/750L	125x100	308	328	78	74	91	-	-	-	-	91	90.8	90.5	90	89.7	88	85.5	83.3	78	71.7	68.5	48	-	-	-	-	-	-	-	-	-	-	-
PSD 100-315/900L	125x100	324	-	85	79	100	-	-	-	-	100	99.8	99.5	99	98.7	96	94.5	92.3	87	80.7	77.5	57	-	-	-	-	-	-	-	-	-	-	-
PSD 125-315/550L	150x125	288	313	56	50	70	-	-	-	-	-	-	-	-	67	66	64	62	59.5	54	50.5	-	-	-	-	-	-	-	-	-	-	-	
PSD 125-315/750L	150x125	306	328	78	74	80	-	-	-	-	-	-	-	-	76.5	75.5	74	72	70	67	65	56	-	-	-	-	-	-	-	-	-	-	-
PSD 125-315/900L	150x125	318	-	85	79	87	-	-	-	-	-	-	-	-	84	82.5	81	79	77	73.5	71.5	65	60	-	-	-	-	-	-	-	-	-	-
PSD 125-315/1100L	150x125	328	-	118	112	97	-	-	-	-	-	-	-	-	94	92.8	91	89.3	87.4	84	83.5	76	71	-	-	-	-	-	-	-	-	-	-

**DIESEL TECHNICAL DATA/DATOS TÉCNICOS DIESEL/DONNÉES TECHNIQUES DIESEL**

Model Modelo Modèle	F2L912	F3L912	F4L912	F6L912	F4L913	F6L913	BF4L913	BF6L913	BF6L913C
Type Tipo Type	4 strokes,Air cooling/4 tiempos,Refrigeración por aire/4 temps, refroidissement par air								
Intake Type Tipo de aspirada Type d'admission	Naturally Aspirated/Aspiración natural/Aspiration naturelle						Turbo-charging/Turbocarga/Turbo-charge		
Bore*Stroke(mm) Diámetro*Carrera(mm) Alésage * Course(mm)	100*120	100*120	100*120	100*120	102*125	102*125	102*125	102*125	102*125
Cylinder No. Cilindro No. N° de cylindre	2	3	4	6	4	6	4	6	6
Displacement Desplazamiento Déplacement	1.88L	2.828L	3.77L	5.655L	4.086L	6.128L	4.086L	6.128L	6.128L
r/min	2300/2500	2300/2500	2300/2500	2300/2500	2300/2500	2300/2500	2300/2500	2300/2500	2300/2500
Rated kW kW nominal kW nominale	20kW/21kW	36kW/38kW	46kW/51kW	74kW/78kW	50kW/56kW	79kW/85kW	68kW/78kW	112kW/118kW	125kW/141kW
Rated HP HP nominal HP nominale	27HP/29HP	49HP/52HP	63HP/69HP	101HP/106HP	68HP/76HP	107HP/116HP	93HP/106HP	152HP/161HP	170HP/192HP
Fuel Consumption(g/kw.h) El consumo combustible Consommation carburant	230	221	221	221	221	228	221	225	220
Start Voltage Voltaje de inicio Tension de démarrage	12/24V	12/24V	12/24V	12/24V	12/24V	12/24V	12/24V	12/24V	12/24V
Speed regulation type Tipo regulación Type régulation vitesse	Mechanical/Mecánico/Mécanique								
Weight/Peso/Poid (kgs)	245	275	300	410	310	420	350	485	510

## TECHNICAL SHEET/HOJA TÉCNICA/FICHE TECHNIQUE

Model/Modelo/Modèle	PV	
Capacity/Caudal/Débit	0-48	m <sup>3</sup> /h
Head/Altura/Hauteur	0-176	m
DN	25-65	mm
Speed/Velocidad/Vitesse	3500	rpm
T max	120	°C
Power/Potencia/Puiss.	1.1-11	kW
Voltage/Voltaje/Tension	220/380/400/440	V
HZ	60	
Class/Clase/Classe	Class F/IP 55	
Duty/Servicio/Devoir	S1 continuous	
Casing/Cuerpo/Corps	Grey Cast Iron Hierro fundido gris Fonte grise	
Impeller/Impulsor/Roue	Plastic Plástico Plastique	
Shaft/Eje/Arbre	AISI304 Inox304 Inox304	
Shaft seal/Sello/Scellé	Mechanical Seal Sello mecánico Garniture mécanique	
Bearing/Rodamiento/Palier	Grease lubrication rolling bearing Rodamientos lubricación con grasa Roulement lubrification à la graisse	

**Jockey/Jockey/Jockey**

- Jockey pump to maintain the necessary pressure in the system
- Bomba jockey para mantener la presión necesaria en el sistema
- Pompe jockey pour maintenir la pression nécessaire dans le système

 Plastic impeller type  
 Tipo impulsor plástico  
 Type roue en plastique

## TECHNICAL SHEET/HOJA TÉCNICA/FICHE TECHNIQUE

Model/Modelo/Modèle	PVT/S	
Capacity/Caudal/Débit	0-110	m <sup>3</sup> /h
Head/Altura/Hauteur	0-305	m
DN	25-100	mm
Speed/Velocidad/Vitesse	3500	rpm
T max	120	°C
Power/Potencia/Puiss.	0.37-45	kW
Voltage/Voltaje/Tension	220/380/400/440	V
HZ	60	
Class/Clase/Classe	Class F/IP 55	
Duty/Servicio/Devoir	S1 continuous	
Casing/Cuerpo/Corps	Grey Cast Iron Hierro fundido gris Fonte grise	
Impeller/Impulsor/Roue	AISI304 Inox304 Inox304	
Shaft/Eje/Arbre	AISI304 Inox304 Inox304	
Shaft seal/Sello/Scellé	Mechanical Seal Sello mecánico Garniture mécanique	
Bearing/Rodamiento/Palier	Grease lubrication rolling bearing Rodamientos lubricación con grasa Roulement lubrification à la graisse	

**Jockey/Jockey/Jockey**

- Jockey pump to maintain the necessary pressure in the system
- Bomba jockey para mantener la presión necesaria en el sistema
- Pompe jockey pour maintenir la pression nécessaire dans le système

 SS304 impeller type  
 Tipo impulsor inox  
 Type de roue inox

**NEW/NUEVO/NOUVEAU**

## DESCRIPTION/DESCRIPCIONES/DESCRIPTION

- The jockey pump is designed to maintain the pressure on the fire protection system between preset limits when the system is not flowing water.
  - Rated capacity not less than any normal leakage rate.
  - Discharge pressure sufficient to maintain the desired fire protection system pressure.
  - YE3 high efficient motor, with protection IP55 class F
- La bomba jockey está diseñada para mantener la presión sobre los sistemas de protección contra incendios entre los límites preestablecidos cuando el sistema no fluye agua
  - Tener una capacidad nominal no menor que cualquier tasa de fuga normal
  - Tener una presión de descarga suficiente para mantener la presión deseada del sistema de protección contra incendios
  - Motor de alta eficiencia YE3, con protección IP55 clase F
- La pompe jockey est conçue pour maintenir la pression sur le (s) système (s) de protection contre les incendies entre les limites prédéfinies lorsque le système ne coule pas.
  - Capacité nominale non inférieure à tout taux de fuite normal.
  - Pression de décharge suffisante pour maintenir la pression souhaitée du système de protection contre les incendies.
  - Moteur haute efficacité YE3, avec protection IP55 classe F

**MODEL CODE/CÓDIGO MODELO/CODE MODÈLE**

For example/Por ejemplo/Par exemple

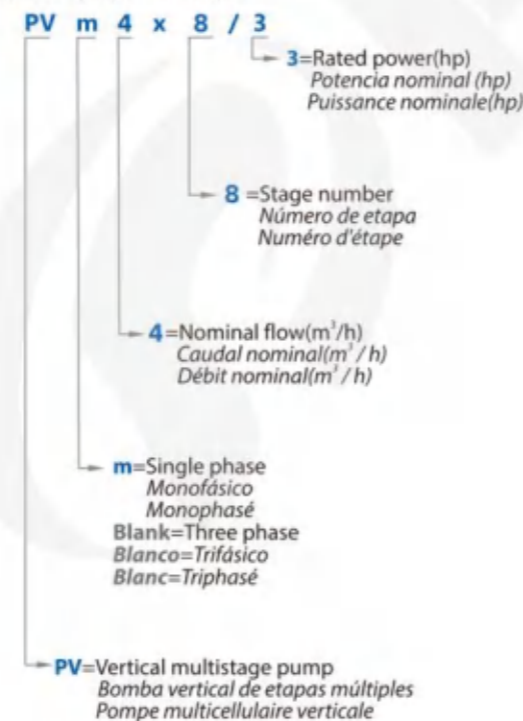

**NEW/NUEVO/NOUVEAU**

## DESCRIPTION/DESCRIPCIONES/DESCRIPTION

- The jockey pump is designed to maintain the pressure on the fire protection system between preset limits when the system is not flowing water.
  - Rated capacity not less than any normal leakage rate.
  - Discharge pressure sufficient to maintain the desired fire protection system pressure.
  - YE3 high efficient motor, with protection IP55 class F
- La bomba jockey está diseñada para mantener la presión sobre los sistemas de protección contra incendios entre los límites preestablecidos cuando el sistema no fluye agua
  - Tener una capacidad nominal no menor que cualquier tasa de fuga normal
  - Tener una presión de descarga suficiente para mantener la presión deseada del sistema de protección contra incendios
  - Motor de alta eficiencia YE3, con protección IP55 clase F
- La pompe jockey est conçue pour maintenir la pression sur le (s) système (s) de protection contre les incendies entre les limites prédéfinies lors que le système ne coule pas.
  - Capacité nominale non inférieure à tout taux de fuite normal.
  - Pression de décharge suffisante pour maintenir la pression souhaitée du système de protection contre les incendies.
  - Moteur haute efficacité YE3, avec protection IP55 classe F

**MODEL CODE/CÓDIGO MODELO/CODE MODÈLE**

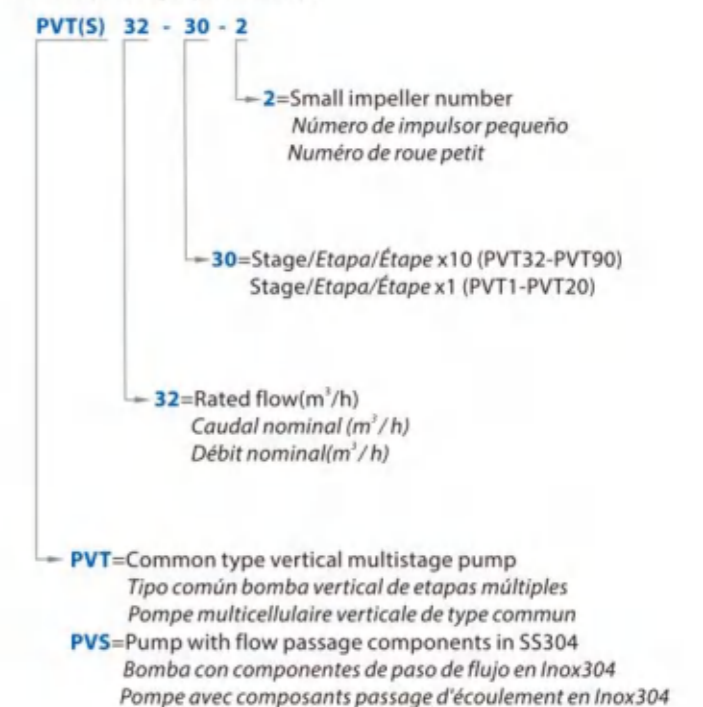
For example/Por ejemplo/Par exemple



**NEW/NUEVO/NOUVEAU**
**DESCRIPTION/DESCRIPCIONES/DESCRIPTION**

- Equipped with **Smartgen** display screen, integrates digitalization, intellectualization and network technologies for precise data measurement, alarm protection, remote control, measuring and communication
  - DOL or Star Delta starter
  - All controllers completely assembled, wired, and tested
  - Self-acting to start, run, and protect the driver
  - Automatic or manual operation options
- Equipado con una pantalla de visualización **Smartgen**, se integra con las tecnologías de digitalización, intelectualización y red para la medición precisa de datos, protección de alarmas, control remoto, medición y comunicación
  - DOL o Star Delta starter
  - Todos los controladores completamente cableados y probados
  - De acción automática para iniciar, ejecutar y proteger al conductor
  - Opciones de operación automática o manual
- Équipé d'un écran d'affichage **Smartgen**, s'intègre aux technologies de numérisation, d'intellectualisation et de réseau pour la mesure précise des données, la protection des alarmes, la télécommande, la mesure et la communication
  - Démarrageur DOL ou Star Delta
  - Tous les contrôleurs sont complètement assemblés, câblés et testés
  - Agit automatiquement pour démarrer, exécuter et protéger le conducteur
  - Options de fonctionnement automatique ou manuel

**Controller/Controladora /Contrôleur**

- Fire pump controllers are used to monitor and to start and stop fire pumps
- Los controladores se utilizan para monitorear y para iniciar y detener bombas
- Les contrôleurs sont utilisés pour surveiller et pour démarrer et arrêter les pompes

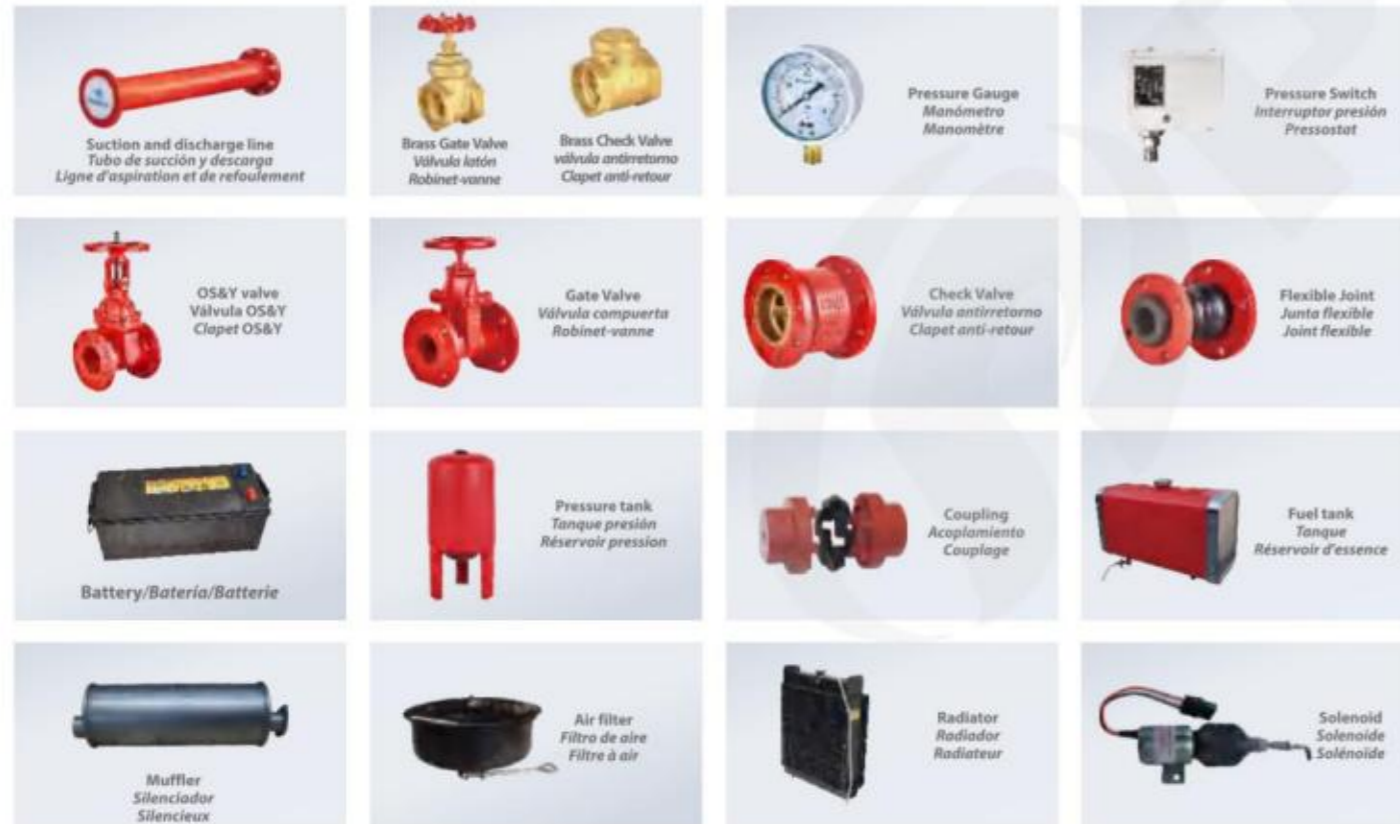
**PVK**
**Jockey+Tank system  
Sistema de Jockey+Tanque  
Système Jockey + Tank**
**OTHER ACCESSORIES/OTROS ACCESORIOS/AUTRES ACCESSOIRES**

**NEW/NUEVO/NOUVEAU**
**DESCRIPTION/DESCRIPCIONES/DESCRIPTION**

- New jockey+tank system design
  - Original design by PURITY
  - YE3 high efficient motor, with protection IP55 class F
  - Pump case with anti-corrosive coating
  - Impeller in techno-polimer
  - Shaft in stainless steel AISI 304 or galvanized iron
  - Quality NSK bearing, wear resistance mechanical seal
- Nuevo diseño de sistema de jockey+tanque
  - Diseño original de PURITY (Patentado)
  - Motor de eficiencia YE3 con Protección IP55 clase F
  - Cuerpo de bomba con tratamiento anti-corrosión
  - Impulsor en tecnopolímero
  - Eje de la bomba en inox AISI304 o hierro galvanizado
  - Rodamiento de marca NSK y cierre mecánico personalizado
- Nouvelle conception du système jockey + tank
  - Design original par PURITY
  - Moteur haute efficacité YE3, avec protection IP55 classe F
  - Boîtier de pompe avec revêtement anti-corrosif
  - Turbine en techno-polimer
  - Arbre en acier inoxydable AISI 304 ou en fer galvanisé
  - Roulement NSK de qualité, joint mécanique résistance à l'usure

**USING LIMITS/LÍMITES UTILIZACIÓN/UTILISATION LIMITES**

- Liquid temperature between -10°C and +120°C
  - Ambient temperature between -10°C and +50°C
  - Max. working pressure **25 bar**
  - Continuous service **S1**
- Temperatura del líquido de -10 °C hasta +120 °C
  - Temperatura ambiente de -10 °C hasta +50 °C
  - Presión máxima en el cuerpo de la bomba **25 bar**
  - Funcionamiento continuo **S1**
- Température du liquide entre -10 °C et +120 °C
  - Température ambiante entre -10 °C et +50 °C
  - Max. pression de service **25 bar**
  - Service continu **S1**

**TECHNICAL DATA/DATOS TÉCNICOS/DONNÉES TECHNIQUES**

Model Modelo Modèle	Flow Caudal Débit	Head Altura Hauteur	Power Potencia Puissance	Jockey Jockey Jockey	Tank Tanque Réservoir
	GPM	Bar	hp		L
PVK25/3	25	7	3	PV 6×7/3	60
PVK35/4	35	7	4	PV 8×8/4	60
PVK50/5.5	50	8	5.5	PV 12×7/5.5	60
PVK75/7.5	75	8	7.5	PV 12×9/7.5	60
PVK100/10	100	8	10	PV 30×5/10	100
PVK125/12	125	8	12	PV 30×6/12	100
PVK150/15	150	9	15	PV 30×8/15	100

*New*



**PTD**



**Inline circulation pump**  
**Bomba de circulación en línea**  
**Pompe de circulation en ligne**

**NEW/NUEVO/NOUVEAU**

**DESCRIPTION/DESCRIPCIONES/DESCRIPTION**

- ◆ Single-stage centrifugal pumps in inline design
  - ◆ With high temperature seal for using in heating systems
  - ◆ Easily back pull-out from motor for coupling design
  - ◆ YE3 high efficient motor, with protection IP55 class F
  - ◆ Pump case with anti-corrosive coating
  - ◆ Shaft in stainless steel AISI 304
  - ◆ Quality NSK bearing, wear resistance mechanical sea
- ◆ Bombas centrifugas de una etapa en diseño en línea.
  - ◆ Con cierre de alta temperatura para sistemas calefacción
  - ◆ Extracción fácil del motor para el diseño del acoplamiento
  - ◆ Motor de alta eficiencia YE3, con protección IP55 clase F
  - ◆ Caja de bomba con revestimiento anticorrosivo
  - ◆ Eje en acero inoxidable 304
  - ◆ Rodamiento de marca NSK y cierre mecánico personalizado
- ◆ Pompes centrifuges à un étage de conception en ligne
  - ◆ Avec garniture haute température pour les systèmes chauffage
  - ◆ Retrait facile du moteur pour la conception de l'accouplement
  - ◆ Moteur haute efficacité YE3, avec protection IP55 classe F
  - ◆ Boîtier de pompe avec revêtement anti-corrosif
  - ◆ Arbre en acier inoxydable 304
  - ◆ Roulement NSK qualité, joint mécanique de résistance à l'usure

**APPLICATIONS/APLICACIONES/APPLICATIONS**

- ◆ Heating system: heating cycle, boiler mixed flow, temperature mixed flow, intermittent heating, domestic water cycle.
  - ◆ Air conditioning system: chilled cooling water circulation.
  - ◆ Water supply system: filtration and transmission, pipeline pressurization.
  - ◆ Industrial production: flushing and cleaning system, boiler feed water, cooling water circulation, water treatment system, equipment leather cover facilities, fire protection system.
- ◆ Sistema de calefacción: ciclo de calefacción, caldera de flujo mixto, flujo mixto de temperatura, calefacción intermitente, ciclo de agua doméstica.
  - ◆ Sistema de aire acondicionado: circulación de agua fría de refrigeración.
  - ◆ Sistema de abastecimiento de agua: filtración y transmisión, presurización de tuberías.
  - ◆ Producción Industrial: sistema de lavado y limpieza, agua de alimentación de caldera, circulación de agua de refrigeración, sistema de tratamiento de agua, instalaciones de revestimiento de cuero, sistema de protección contra incendios.
- ◆ Système de chauffage: cycle de chauffage, écoulement mixte de chaudière, écoulement mixte de température, chauffage intermittent, cycle de l'eau domestique.
  - ◆ Système de climatisation: circulation d'eau de refroidissement réfrigérée. Système d'approvisionnement en eau: filtration et transmission, pressurisation des pipelines.
  - ◆ Production industrielle: système de rinçage et de nettoyage, eau d'alimentation de la chaudière, circulation de l'eau de refroidissement, système de traitement de l'eau, équipements de couverture en cuir, système de protection contre l'incendie.

**USING LIMITS/LÍMITES UTILIZACIÓN/UTILISATION LIMITES**

- ◆ Liquid temperature between **-15°C** and **+110°C**
  - ◆ Ambient temperature maximum **+40°C**
  - ◆ Max. working pressure **16 bar/Continuo S1**
- ◆ Temperatura del líquido de **-15°C** hasta **+110°C**
  - ◆ Temperatura ambiente de **+40°C**
  - ◆ Presión máxima **16 bar/Continuo S1**
- ◆ Température du liquide entre **-15°C** et **+110°C**
  - ◆ Température ambiante entre **+40°C**
  - ◆ Max. pression de service **16 bar/Continu S1**

**Conditions of Use**

Protection grade: IP55  
Flow range: 8-900m<sup>3</sup>/h  
Head range: 9-81m  
Power range: 0.75~260kW  
Maximum working pressure: 12bar for conventional type;  
Special type is 16bar  
Liquid temperature: -15°C to 110°C  
Ambient temperature: maximum +40°C  
Altitude: up to 1000 m  
Rotation direction: clockwise (looking down at the motor blade end)

**MODEL CODE/CÓDIGO MODELO/CODE MODÈLE**

For example/Par ejemplo/Par exemple



For example/Par ejemplo/Par exemple

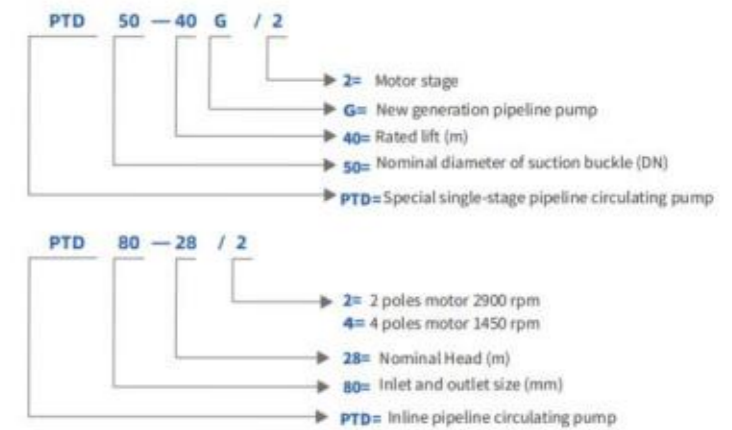

**DIMENSIONS AND WEIGHT/DIMENSIONES Y PESOS/DIMENSIONS ET POIDS**

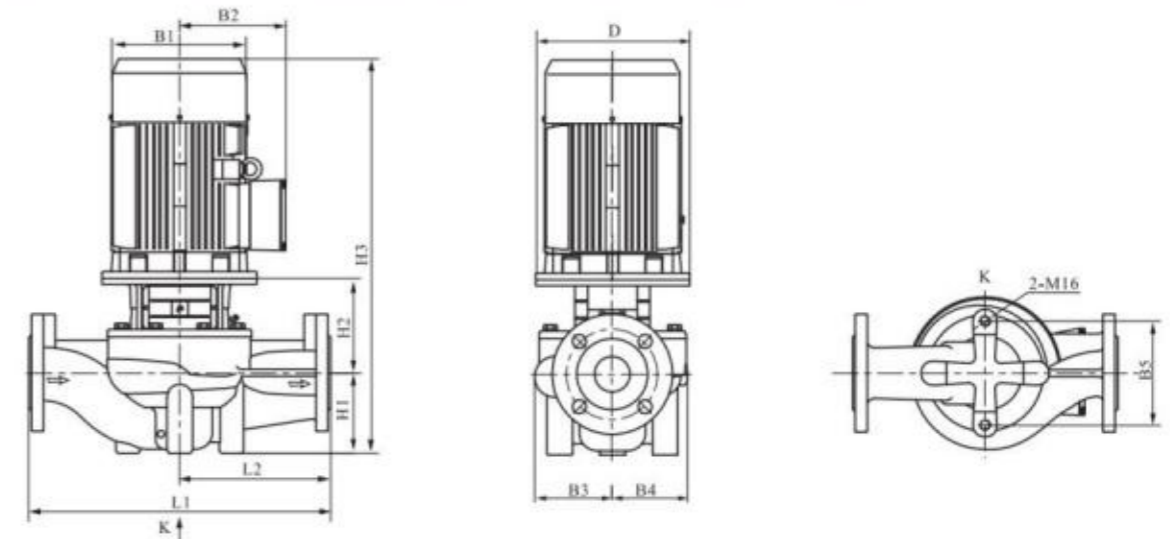



MODEL MODELO MODÈLE	Q m³/h	H m	P kW	RPM	DIMENSIONS/DIMENSIONES/DIMENSIONS mm											KG
					D	B1	B2	B3	B4	B5	H1	H2	H3	L1	L2	
PTD32-14G/2	8	14	0.75	3500	120	151	125	101	101	144	90	135	469	320	160	33
PTD32-18G/2	8	18	1.1	3500	120	151	125	101	101	144	90	135	469	320	160	34
PTD32-21G/2	12.5	21	1.5	3500	140	171	137	101	101	144	90	137	514	320	160	38
PTD32-26G/2	12.5	26	2.2	3500	140	171	137	101	101	144	90	137	514	320	160	42
PTD32-33G/2	12.5	33	3	3500	160	196	150	109	109	144	90	145	572	340	170	52
PTD32-40G/2	12.5	40	4	3500	160	214	169	128	128	144	100	151	593	360	180	65
PTD32-50G/2	12.5	50	5.5	3500	200	257	190	128	128	144	100	173	656	360	180	84
PTD40-14G/2	8	14	0.75	3500	122	151	125	98	95	120	68	139	451	320	160	31
PTD40-16G/2	12.5	16	1.1	3500	122	151	125	98	95	120	68	139	451	320	160	32
PTD40-21G/2	12.5	21	1.5	3500	140	171	137	98	95	120	68	149	504	320	160	38
PTD40-20G/2	20	20	2.2	3500	140	171	137	105	95	144	85	144	516	320	160	43
PTD40-26G/2	20	26	3	3500	160	196	150	116	109	144	85	156	578	340	170	54
PTD40-30G/2	25	30	4	3500	160	214	169	116	109	144	85	156	583	340	170	62
PTD40-36G/2	25	36	5.5	3500	200	257	190	133	128	144	90	181	654	380	190	85
PTD40-48G/2	25	48	7.5	3500	200	257	190	133	128	144	90	181	654	380	190	94
PTD50-12G/2	16	12	1.1	3500	120	151	125	114	101	144	105	135	484	340	170	37
PTD50-15G/2	20	15	1.5	3500	140	171	137	114	101	144	105	137	529	340	170	42
PTD50-18G/2	25	18	2.2	3500	140	171	137	114	101	144	105	137	529	340	170	45
PTD50-24G/2	25	24	3	3500	160	196	150	114	101	144	105	147	589	340	170	55
PTD50-28G/2	30	28	4	3500	160	214	169	118	109	144	105	152	599	340	170	54
PTD50-32G/2	12.5	32	3	3500	160	196	150	128	128	144	105	150	592	400	200	64
PTD50-35G/2	30	35	5.5	3500	200	257	190	118	109	144	105	176	664	340	170	81
PTD50-39G/2	12.5	39	4	3500	160	214	169	128	128	144	105	150	597	400	200	71
PTD50-40G/2	35	40	7.5	3500	200	257	190	142	138	144	105	175	663	400	200	98
PTD50-49G/2	12.5	49	5.5	3500	200	257	190	128	128	144	105	172	660	400	200	88
PTD50-50G/2	40	50	11	3500	350	314	261	142	138	144	105	255	830	400	200	173
PTD50-59G/2	12.5	59	7.5	3500	200	257	190	163	163	144	105	178	666	440	220	112
PTD50-60G/2	50	60	15	3500	350	314	261	171	163	144	115	225	840	440	220	196
PTD50-70G/2	50	70	18.5	3500	350	314	261	171	163	144	115	225	884	440	220	174
PTD50-80G/2	12.5	80	11	3500	350	314	261	163	163	144	105	222	827	440	220	184
PTD50-81G/2	50	81	22	3500	350	355	273	171	163	144	115	225	917	440	220	256
PTD65-15G/2	30	15	2.2	3500	140	171	137	116	101	144	105	153	545	340	170	48
PTD65-20G/2	30	20	3	3500	160	196	150	116	101	144	105	163	605	340	170	57
PTD65-22G/2	40	22	4	3500	160	214	169	116	101	144	105	163	610	340	170	64
PTD65-30G/2	40	30	5.5	3500	160	257	190	131	115	144	105	194	682	360	180	85
PTD65-34G/2	50	34	7.5	3500	200	257	190	131	115	144	105	194	682	360	180	94
PTD65-37G/2	25	37	5.5	3500	200	257	190	128	128	144	105	180	668	400	200	90
PTD65-41G/2	50	41	11	3500	200	314	261	148	138	144	105	234	839	400	200	173
PTD65-48G/2	25	48	7.5	3500	350	257	190	128	128	144	105	180	668	400	200	98
PTD65-51G/2	50	51	15	3500	200	314	261	148	138	144	105	234	839	400	200	188
PTD65-61G/2	50	61	18.5	3500	350	314	261	174	162	160	125	228	897	475	238	177
PTD65-68G/2	50	68	22	3500	350	355	273	174	162	160	125	228	930	475	238	260
PTD65-85G/2	50	85	30	3500	400	397	314	174	162	160	125	231	1008	475	238	322
PTD80-13G/2	50	13	3	3500	160	196	150	134	112	144	105	171	613	400	200	63
PTD80-18G/2	50	18	4	3500	160	214	169	134	112	144	105	171	618	400	200	70
PTD80-23G/2	50	23	5.5	3500	200	257	190	134	112	144	105	195	683	400	200	87
PTD80-29G/2	50	29	7.5	3500	200	257	190	134	112	144	105	195	683	400	200	95
PTD80-32G/2	70	32	11	3500	350	314	261	159	138	144	115	240	855	450	225	179
PTD80-38G/2	80	38	15	3500	350	314	261	159	138	144	115	240	855	450	225	194
PTD80-41G/2	50	41	11	3500	350	314	261	137	128	144	115	221	836	500	250	176
PTD80-47G/2	80	47	18.5	3500	350	314	261	137	128	144	115	221	836	500	250	191
PTD80-48G/2	50	48	15	3500	350	314	261	159	138	144	115	240	899	450	225	203
PTD80-54G/2	80	54	22	3500	350	355	273	159	138	144	115	250	932	450	225	256
PTD80-67G/2	80	67	30	3500	400	397	314	180	162	160	115	242	1009	500	250	324
PTD100-9/2	50	9	2.2	3500	140	171	137	134	101	160	108	172	573	450	225	65
PTD100-15/2	60	15	4	3500	160	214	169	134	101	160	108	190	675	450	225	83
PTD100-17/2	80	17	5.5	3500	200	257	190	146	117	144	145	215	780	500	250	119
PTD100-22/2	80	22	7.5	3500	200	257	190	146	117	144	145	215	780	500	250	122

MODEL MODELO MODÈLE	Q m³/h	H m	P kW	RPM	DIMENSIONS/DIMENSIONES/DIMENSIONS mm											KG
					D	B1	B2	B3	B4	B5	H1	H2	H3	L1	L2	
PTD100-27/2	100	27	11	3500	350	314	261	147	123	144	140	260	900	550	275	183
PTD100-33/2	100	33	15	3500	350	314	261	147	123	144	140	260	900	550	275	194
PTD100-40/2	100	40	18.5	3500	350	314	261	181	154	230	140	270	960	550	275	224
PTD100-48/2	100	48	22	3500	350	355	273	181	154	230	140	270	985	550	275	260
PTD100-52/2	130	52	30	3500	400	397	314	181	154	230	140	270	1060	550	275	318
PTD125-11/4	120	11	5.5	1750	200	257	190	216	176	230	215	228	873	620	310	166
PTD125-14/4	120	14	7.5	1750	200	257	190	216	176	230	215	228	873	620	310	179
PTD125-18/4	160	18	11	1750	350	314	261	211	178	230	160	304	989	660	330	257
PTD125-20/4	120	20	11	1750	350	314	261	235	210	230	215	292	1012	800	400	289
PTD125-22/4	160	22	15	1750	350	314	261	235	210	230	215	292	1047	800	400	301
PTD125-28/4	160	28	18.5	1750	350	355	273	235	210	230	215	292	1084	800	400	321
PTD125-32/4	160	32	22	1750	350	355	273	235	210	230	215	292	1122	800	400	356
PTD125-40/4	160	40	30	1750	400	397	314	271	250	230	220	297	1179	800	400	442
PTD125-48/4	160	48	37	1750	400	445	334	271	250	230	220	315	1204	800	400	498
PTD150-12.5/4	200	12.5	11	1750	350	314	261	217	180	230	215	272	1003	800	400	275
PTD150-17/4	200	17	15	1750	350	314	261	217	180	230	215	272	1045	800	400	278
PTD150-21/4	200	21	18.5	1750	350	355	273	217	180	230	215	272	1082	800	400	313
PTD150-25/4	200	25	22	1750	350	355	273	238	208	230	215	269	1099	800	400	354
PTD150-33/4	200	33	30	1750	400	397	314	238	208	230	215	269	1133	800	400	406
PTD150-40/4	200	40	37	1750	450	445	334	267	248	230	230	288	1192	900	450	511
PTD150-50/4	200	50	45	1750	450	445	334	267	248	230	230	288	1215	900	450	548
PTD200-12.5/4	400	12.5	22	1750	350	355	273	278	219	360	270	415	1300	1100	500	432
PTD200-16/4	300	16	18.5	1750	350	355	273	278	219	360	270					



No.	Description Descripción Description	Material Matériel
1	Fan Cover Tapa/Capot	Aluminum Aluminio/Aluminium
2	Fan Ventilador/Ventilateur	Plastic Plástico/Plastique
3	Back cover Tapa Trasera/Capot Arrière	Cast iron Fundición/Fonte
4	Through Bolt Perno/Boulon	Steel Acero/Acier
5	Motor Case Cuerpo Motor/Boitier Moteur	Aluminum Aluminio/Aluminium
6	Wound Stator Estator/Stator	Silicon-copper Silicio-Cobre/Silicium-Cuivre
7	Impeller Key Chaveta/Clé	Iron Hierro/Le fer
8	Rotor Rotor/Rotor	Silicon Steel Acero Silicio/Acier Silicium
9	Bearing Rodamiento/Palier	Ball Bearing Bola Rodamiento/Palier Balle
10	Motor Cover Tapa Motor/Capot Moteur	Cast iron Fundición/Fonte
11	Terminal Board Tablero Bornas/Bornier	Plastic Plástico/Plastique
12	Capacitor Capacitor/Condensateur	Plastic Plástico/Plastique
13	Pad Almohadilla/Tampon	Rubber Caucho/Caoutchouc
14	Terminal Box Caja Bornas/Boite Bornes	Aluminum Aluminio/Aluminium
15	Coupling Unión/Couplage	Steel Acero/Acier
16	Shaft Eje/Arbre	SS304 Inox 304/Inox 304
17	Connection Conexión/Lien	Cast iron Fundición/Fonte
18	Case Cover Tapa Cuerpo/Capot Boitier	SS304 Inox 304/Inox 304
19	Release Valve Tapón Cebado/Vanne Purge	Brass Bronce/Laiton
20	Mechanical Seal Cierre Mecánico/Sceller	SiC-Carbon Silicio-Grafito/Silicium-Carbon
21	Impeller Impulsor/Roue	Cast iron Fundición/Fonte
22	Washer Arandela/Rondelle	Steel Acero/Acier
23	Impeller Nut Nuez/Noix	Galvanized Steel Acero Galvanizado/Acier Galvanisé
24	O-ring Junta Tórica/Joint Torique	Rubber Caucho/Caoutchouc
25	Pump Case Cuerpo/Boitier	Cast iron Fundición/Fonte

SPECTRAL DIAGRAM

PTD single -level pipeline circulation pump  
 diameter range: 32-300mm  
 Power range: 0.75-260kW  
 2 poles below 100 caliber and 4 poles above 125 caliber

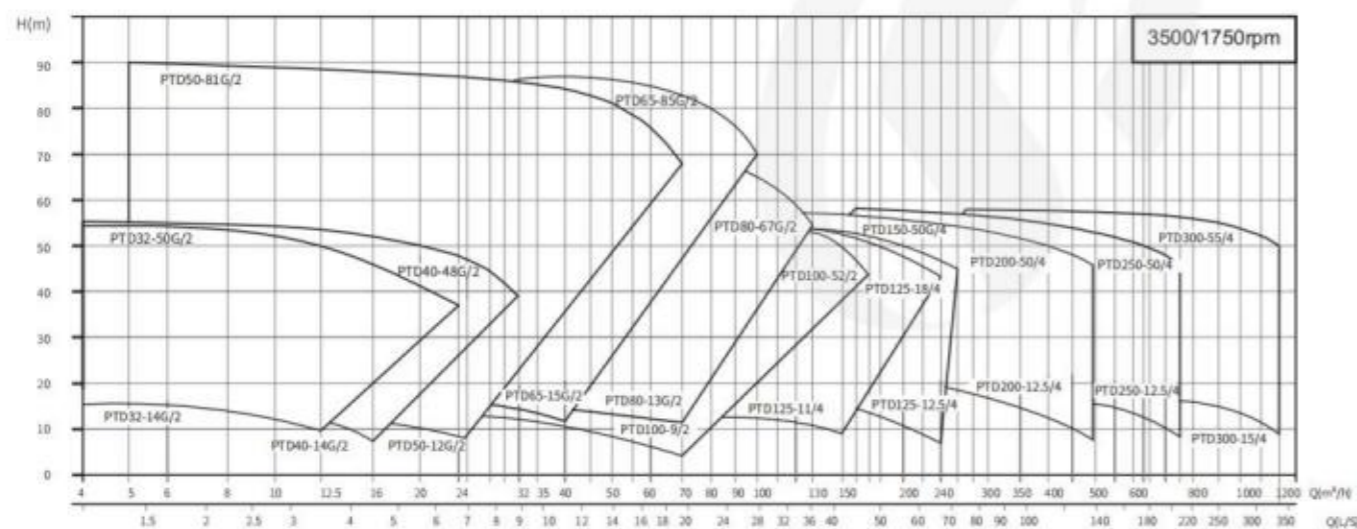

# PTD

## NEW INLINE CIRCULATION PUMP





PW

Same port centrifugal pump  
 Bomba centrífuga misma puerto  
 Pompe centrifuge même port



60Hz n=3500 r/min

MODEL MODELO MODÈLE	DN mm	Power Potencia Puissance		Q=DELIVERY/CAUDAL/DÉBIT																
		kw	hp	l/min	100	150	250	300	400	450	600	700	800	900	1200	1400	1500	1800	2000	2300
				m <sup>3</sup> /h	6	9	15	18	24	27	36	42	48	54	72	84	90	108	120	138
				H=Head/Altura/Hauteur(m)																
PW 80-125/22	80x80	2.2	3	17	-	-	-	-	-	-	15.4	14	12.8	11.5	6.5	-	-	-	-	
PW 80-125/30	80x80	3	4	20	-	-	-	-	-	-	18.8	18	17	15.6	11	-	-	-	-	
PW 80-125/40	80x80	4	5.5	24	-	-	-	-	-	-	23.1	23	21.5	20.3	15.8	11.8	-	-	-	
PW 80-160/55	80x80	5.5	7.5	32	-	-	-	-	-	-	30.6	30	28	26.6	20.5	14.8	-	-	-	
PW 80-160/75	80x80	7.5	10	40	-	-	-	-	-	-	38	37	36	34.4	29	24	21	-	-	
PW 80-200/92	80x80	9.2	12.5	50.5	-	-	-	-	-	-	46.8	45	43	40.9	32.5	25.7	-	-	-	
PW 80-200/110	80x80	11	15	57.5	-	-	-	-	-	-	53.5	52	50	47.5	40	33	29	-	-	
PW 80-250/150	80x80	15	20	68.5	-	-	-	-	-	-	64	63	61.5	59	50	41	-	-	-	
PW 80-250/185	80x80	18.5	25	79	-	-	-	-	-	-	75.8	74.8	74	71.5	63.5	55.5	47	-	-	
PW 80-250/220	80x80	22	30	89.5	-	-	-	-	-	-	86	85.3	84	81.5	73.5	65.5	57	-	-	
PW 100-125/40	100x100	4	5.5	19	-	-	-	-	-	-	-	-	17.3	16.8	14.5	13	11.8	-	-	
PW 100-125/55	100x100	5.5	7.5	23	-	-	-	-	-	-	-	-	21.3	20.9	19	17.5	16.7	13.7	-	
PW 100-125/75	100x100	7.5	10	27	-	-	-	-	-	-	-	-	26	25.6	24.5	23	22.5	20	18	
PW 100-160/92	100x100	9.2	12.5	33	-	-	-	-	-	-	-	-	31.5	30	28	27.1	24	21.5	-	
PW 100-160/110	100x100	11	15	36	-	-	-	-	-	-	-	-	34.5	33	31.5	30.8	28	25.5	-	
PW 100-160/150	100x100	15	20	42	-	-	-	-	-	-	-	-	41	40	38.5	37.8	35	33	29.5	
PW 100-200/150	100x100	15	20	45	-	-	-	-	-	-	-	-	45.5	43	41	40.2	36.5	34	-	
PW 100-200/185	100x100	18.5	25	52	-	-	-	-	-	-	-	-	52.3	51	49	48.2	44.5	42	-	
PW 100-200/220	100x100	22	30	59	-	-	-	-	-	-	-	-	59.5	58	56	55	52	49.5	44.5	

NEW/NUEVO/NOUVEAU

DESCRIPTION/DESCRIPCIONES/DESCRIPTION

- New same DN centrifugal pump
  - Original design by PURITY (Patent no.201530478502.0)
  - Both square motor & round motor available
  - YE3 high efficient motor, with protection IP55 class F
  - Pump case with anti-corrosive coating
  - Galvanized counter flange with bolts, nuts and gaskets
  - Quality NSK bearing, wear resistance mechanical seal
- Nuevas bomba centrífuga misma DN
  - Diseño original de PURITY (Patente no.201530478502.0)
  - Motor redondo y cuadrado disponible
  - Motor de eficiencia YE3 con Protección IP55 clase F
  - Cuerpo de bomba con tratamiento anti-corrosión
  - Contrabridas galvanizadas con pernos, tuercas y empaques
  - Rodamiento de marca NSK y cierre mecánico personalizado
- Nouvelle pompe centrifuge même DN
  - Design original par PURITY (Brevet no.201530478502.0)
  - Moteur carré et moteur rond disponibles
  - Moteur haute efficacité YE3, avec protection IP55 classe F
  - Boîtier de pompe avec revêtement anti-corrosif
  - Contre-bride galvanisée avec boulons, écrous et joints
  - Roulement NSK qualité, joint mécanique de résistance à l'usure

USING LIMITS/LÍMITES UTILIZACIÓN/UTILISATION LIMITES

- Liquid temperature between -10°C and +120°C
  - Ambient temperature between 0°C and +50°C
  - Max. working pressure 16 bar/Continuous S1
- Temperatura del líquido de -10 °C hasta +120 °C
  - Temperatura ambiente de 0 °C hasta +50 °C
  - Presión máxima 16 bar/Continuo S1
- Température du liquide entre -10 °C et +120 °C
  - Température ambiante entre 0 °C et +50 °C
  - Max. pression de service 16 bar/Continu S1

APPLICATIONS/APLICACIONES/APPLICATIONS

- For conveying water and other liquids similar to water in physical and chemical properties, suitable for energy, metallurgy, chemical, textile, paper and hotels and other boiler water pressurization transport and urban heating system circulation pump.
- Para el transporte de agua y otros líquidos similares al agua en propiedades físicas y químicas, adecuado para la energía, metalurgia, química, textil, papel y hoteles y otras calderas presurización de agua de transporte y sistema de calefacción urbana bomba de circulación.
- Pour le transport de l'eau et d'autres liquides semblables à l'eau dans les propriétés physiques et chimiques, approprié à l'énergie, à la métallurgie, à la chimie, au textile, au papier et aux hôtels et à d'autres transports de pressurisation d'eau de chaudière et pompe de circulation de système de chauffage Urbain.

MODEL CODE/CÓDIGO MODELO/CODE MODÈLE

For example/Por ejemplo/Par exemple

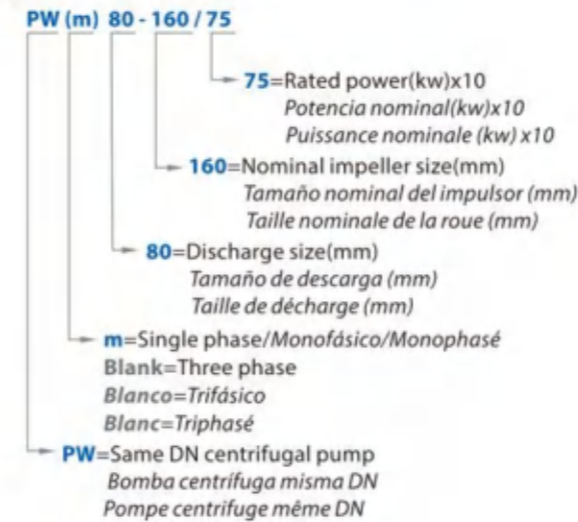

PERFORMANCE CURVE/CURVA DE RENDIMIENTO/COURBE DE PERFORMANCE

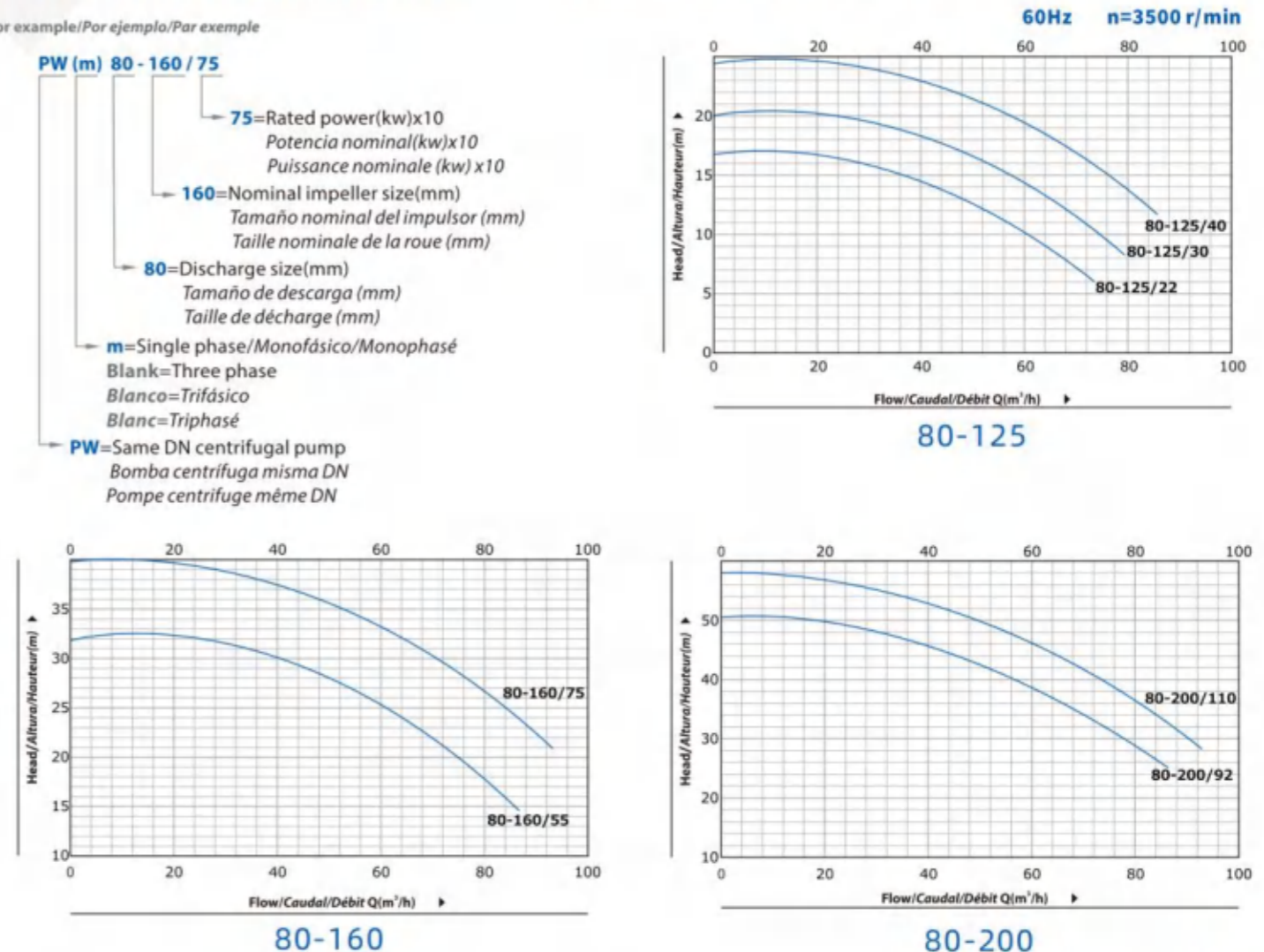

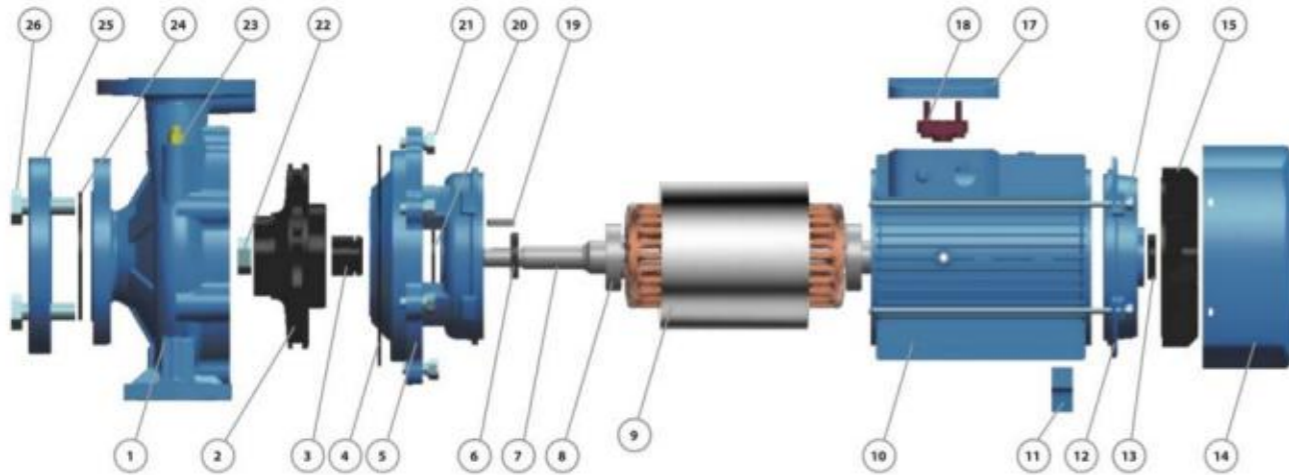
**MATERIAL DESCRIPTION/DESCRIPCIÓN DE MATERIAL/DESCRIPTION DU MATÉRIEL**

No.	Description Descripción Description	Material Material Matériel	No.	Description Descripción Description	Material Material Matériel	No.	Description Descripción Description	Material Material Matériel
1	Pump Case Cuerpo/Boitier	Cast iron Fundición/Fonte	10	Motor Case Cuerpo Motor/Boitier Moteur	Aluminum Aluminio/Aluminium	19	Impeller Key Chaveta/Clé	Iron Hierro/Le fer
2	Impeller Impulsor/Roue	Cast iron Fundición/Fonte	11	Support Foot Soporte Pie/Pied support	Plastic Plástico/Plastique	20	Water Deflector Deflector/Défecteur	Rubber Caucho/Caoutchouc
3	Mechanical Seal Cierre Mecánico/Sceller	SiC-Carbon Silicio-Grafito/Silicium-Carbon	12	Back Cover Tapa Trasera/Capot Arrière	Cast iron Fundición/Fonte	21	Connection Bolt Perno/Boulon	Steel Acero/Acier
4	O-ring	Rubber	13	Reinforced Seal Sello Reforzado/Sceller	Rubber Caucho/Caoutchouc	22	Impeller Nut Nuez/Noix	Galvanized Steel Acero Galvanizado/Acier Galvanisé
5	Joint Toric/Joint Torique	Caucha/Caoutchouc	14	Fan Cover Tapa/Capot	Aluminum Aluminio/Aluminium	23	Release Valve Tapón Cebado/Vanne Purge	Brass Bronce/Laiton
6	Connection Conexión/Lien	Cast iron Fundición/Fonte	15	Fan Ventilador/Ventilateur	Plastic Plástico/Plastique	24	Gasket Empaque/Joint	Rubber Caucho/Caoutchouc
7	Reinforced Seal Sello Reforzado/Sceller	Rubber	16	Through Bolt Perno/Boulon	Steel Acero/Acier	25	Counter Flange Contra Brida/Contre bride	Galvanized Cast iron Fundición Galvanizado/Fonte
8	Shaft Eje/Arbre	SS304-45# Steel Inox 304-Hierro/Inox304-Acier	17	Terminal Box Caja Bornas/Boite Bornes	Aluminum Aluminio/Aluminium	26	Flange Bolt Perno Brida/Boulon bride	Steel Acero/Acier
9	Bearing Rodamiento/Palier	Ball Bearing Bola Rodamiento/Palier Balle	18	Terminal Board Tablero Bornas/Bornier	Plastic Plástico/Plastique			

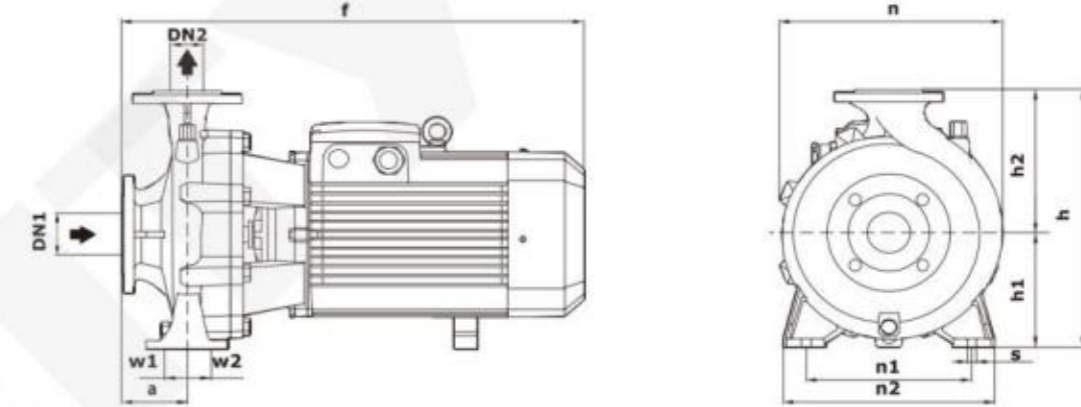
**DIMENSIONS AND WEIGHT/DIMENSIONES Y PESOS/DIMENSIONS ET POIDS**

MODEL/MODELO/MOÛLE		DIMENSIONS/DIMENSIONES/DIMENSIONS mm													kg	
Single-phase Monofásico Monophasé	Three-phase Trifásico Triphasé	DN1	DN2	a	f	h	h1	h2	n	n1	n2	w1	w2	s	1~	3~
80-125/22	80-125/22	80	80	102	525	305	135	170	263	190	245	37	37	8	45	41
80-125/30	80-125/30			102	525	305	135	170	263	190	245				54	50
-	80-125/40			110	560	345	162	193	270	212	262				-	64
-	80-160/55			110	560	345	162	193	270	212	262				-	71
-	80-160/75			104	722	392	186	206	307	232	307				-	90
-	80-200/92			104	722	392	186	206	307	232	307	-	106			
-	80-200/110			102	720	416	186	230	330	250	327	-	145			
-	80-250/150			102	720	416	186	230	330	250	327	-	153			
-	80-250/185			102	720	416	186	230	330	250	327	-	183			
-	80-250/220			102	720	416	186	230	330	250	327	-	183			
-	100-125/40	100	100	104	580	345	162	193	275	212	275	49	49	10	-	56
-	100-125/55			104	580	345	162	193	275	212	275				-	68
-	100-125/75			104	580	345	162	193	275	212	275				-	74
-	100-160/92			102	730	415	186	230	330	250	330				-	90
-	100-160/110			102	730	415	186	230	330	250	330				-	106
-	100-160/150			102	730	415	186	230	330	250	330	-	134			
-	100-160/150			120	740	415	186	230	330	250	330	-	140			
-	100-200/185			120	740	415	186	230	330	250	330	-	145			
-	100-200/185			120	740	415	186	230	330	250	330	-	145			
-	100-200/220			120	740	415	186	230	330	250	330	-	185			

60Hz n = 3500 r/min

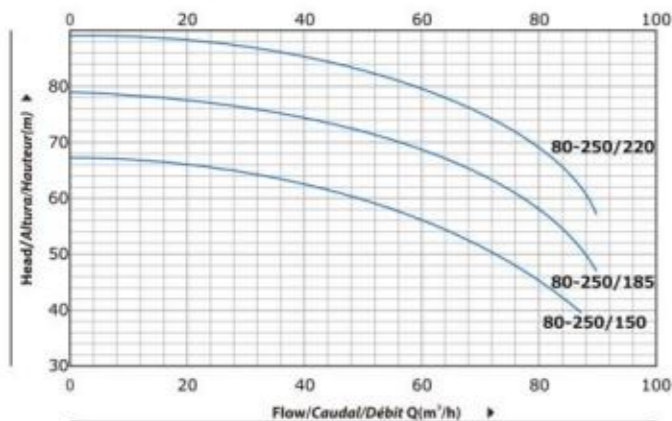

80-250

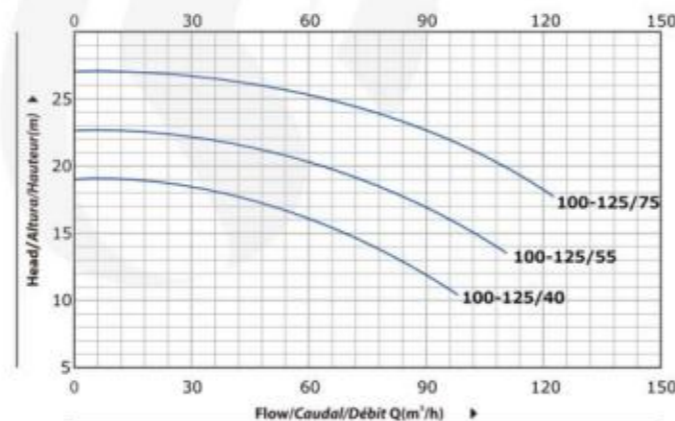

100-125

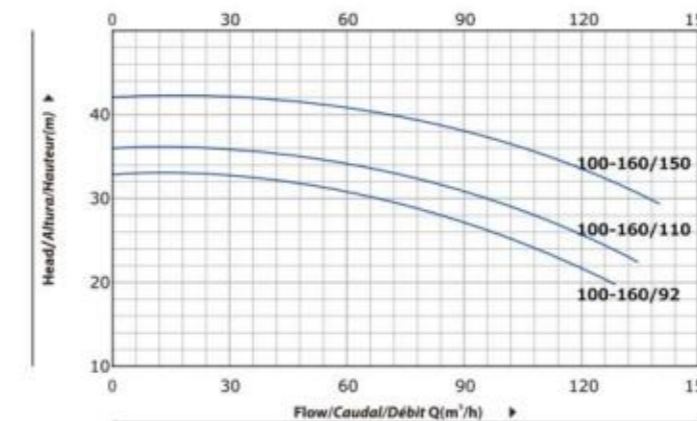

100-160

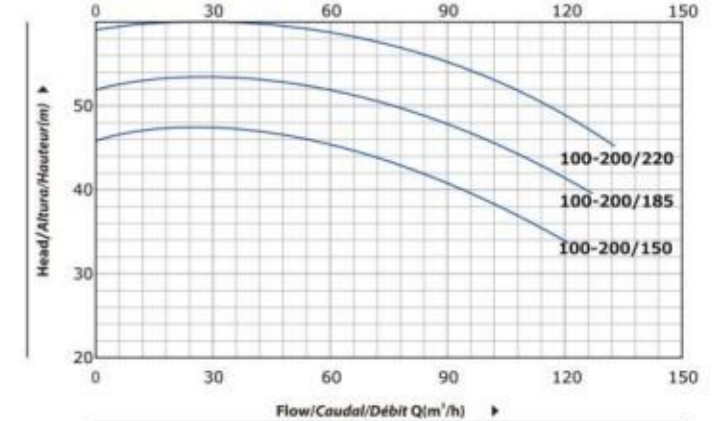

100-200

**PC**



**Thread port centrifugal pump  
Bomba centrífuga roscada  
Pompe centrifuge à orifice fileté**



**NEW/NUEVO/NOUVEAU**

**DESCRIPTION/DESCRIPCIONES/DESCRIPTION**

- ◆ Single impeller centrifugal pumps in thread port design
- ◆ Original design by PURITY (patented no. 201530476290.2)
- ◆ Suitable to cover any capacity request
- ◆ YE3 high efficient motor, with protection IP55 class F
- ◆ Impeller in brass or cast iron
- ◆ Suction and discharge port in G20 thread
- ◆ Quality NSK bearing, wear resistance mechanical seal
- ◆ Bombas centrífugas de impulsor simple en diseño
- ◆ Diseño original de PURITY (patentado no. 201530476290.2)
- ◆ Adecuado para cubrir cualquier solicitud de capacidad
- ◆ Motor de alta eficiencia YE3, con protección IP55 clase F
- ◆ Impulsor en latón o hierro fundido
- ◆ Puerto de succión y descarga en rosca G20
- ◆ Rodamiento de marca NSK y cierre mecánico personalizado

- ◆ Pompes centrifuges à une roue en version orifice fileté
- ◆ Design original par PURITY (breveté no.201530476290.2)
- ◆ Convient pour couvrir toute demande de capacité
- ◆ Moteur haute efficacité YE3, avec protection IP55 classe F
- ◆ Roue en laiton ou en fonte
- ◆ Orifice d'aspiration et de refoulement en filetage G20
- ◆ Roulement NSK qualité, joint mécanique de résistance à l'usure

**APPLICATIONS/APLICACIONES/APPLICATIONS**

- ◆ The high efficiency and continuous duty capabilities makes these pumps ideal for use in activities such as flood and spray irrigation, drawing water from lakes, rivers and wells, or for any number of different industrial applications where the characteristics of high flow rates and mid to low head are required. Suitable for use in civil and agricultural applications.
- ◆ La alta eficiencia y las capacidades de servicio continuo hacen que estas bombas sean ideales para su uso en actividades como riego por inundación y rociado, extracción de agua de lagos, ríos y pozos, o para cualquier número de aplicaciones industriales diferentes donde las características de caudales altos y medios a bajos se requieren cabezales.
- ◆ Le rendement élevé et les capacités de service continu rendent ces pompes idéales pour une utilisation dans des activités telles que l'irrigation par inondation et par pulvérisation, puisant de l'eau dans les lacs, les rivières et les puits, ou pour un certain nombre d'applications industrielles différentes où les caractéristiques des débits élevés et moyens à faibles la tête sont nécessaires.

**USING LIMITS/LÍMITES UTILIZACIÓN/UTILISATION LIMITES**

- ◆ Liquid temperature between -10°C and +120°C
- ◆ Ambient temperature between -10°C and +50°C
- ◆ Max. working pressure 16 bar
- ◆ Continuous service S1
- ◆ Temperatura del líquido de -10 °C hasta +120 °C
- ◆ Temperatura ambiente de -10 °C hasta +50 °C
- ◆ Presión máxima en el cuerpo de la bomba 16 bar
- ◆ Funcionamiento continuo S1
- ◆ Température du liquide entre -10 °C et +120 °C
- ◆ Température ambiante entre -10 °C et +50 °C
- ◆ Max. pression de service 16 bar
- ◆ Service continu S1

MODEL MODELO MODÈLE	DN mm	Power Potencia Puissance kw hp	l/min m³/h	Q=DELIVERY/CAUDAL/DÉBIT																			
				100	150	200	250	300	350	400	500	600	700	800	900	1000	1100	1200	1400	1500	1800	2000	2300
PC 5B	50x50	0.75	1	17.9	16.4	16.5	15	14	13.5	11.4	9.5	5	-	-	-	-	-	-	-	-	-	-	
PC 5BM	50x50	1.1	1.5	20.2	19.2	19	18	17	16	14	12	7.5	-	-	-	-	-	-	-	-	-	-	
PC 5AM	50x50	1.5	2	22.5	22	21.5	21	20	18.5	16.6	14.5	10	-	-	-	-	-	-	-	-	-	-	
PC 220C	50x50	2.2	3	32	31	30.5	30	29	28	26	24	21	-	-	-	-	-	-	-	-	-	-	
PC 220B	50x50	3	4	38	37	36.5	36	34.8	33.5	31.2	29	25	-	-	-	-	-	-	-	-	-	-	
PC 220A	50x50	4	5.5	49	48	47	46	44.8	43.5	41.5	39.5	36	-	-	-	-	-	-	-	-	-	-	
PC 680C	50x50	4	5.5	52	51	50.8	50.3	49	47.5	45	43	40	-	-	-	-	-	-	-	-	-	-	
PC 680B	50x50	5.5	7.5	61	60	59.5	59	58.5	57	55	52.5	50	-	-	-	-	-	-	-	-	-	-	
PC 680A	50x50	7.5	10	75	74.5	74.3	74	73.5	72.5	71	68.5	65	60	-	-	-	-	-	-	-	-	-	
PC 6C	80x80	1.1	1.5	11.9	-	-	11.7	11.5	11.3	11	10.7	10.2	9.2	8	6.7	5	3	-	-	-	-	-	
PC 6B	80x80	1.5	2	14.7	-	-	14.5	14.3	14	13.8	13.5	12.8	12	11	9.7	8.2	6.7	5	-	-	-	-	
PC 6A *	80x80	2.2	3	18.5	-	-	18.1	18	17.8	17.5	17.2	16.8	16	15	13.8	12.2	10.5	8.3	6	-	-	-	
PC 6H *	80x80	3	4	21.5	-	-	21	20.9	20.7	20.4	20	19.5	18.8	17.8	16.5	15	13.5	11.2	9	-	-	-	
PC 560C *	80x80	4	5.5	25	-	-	-	-	-	-	-	-	24.1	24	22.5	21.3	19.8	18.3	16.8	12.8	-	-	
PC 560B	80x80	5.5	7.5	32	-	-	-	-	-	-	-	-	30.6	30	28	26.6	24.8	22.7	20.5	14.8	-	-	
PC 560A	80x80	7.5	10	40	-	-	-	-	-	-	-	-	38	37	36	34.4	32.6	30.8	29	24	21	-	
PC 8C *	100x100	2.2	3	18.5	-	-	18.1	18	17.8	17.5	17.2	16.8	16	15	13.8	12.2	10.5	8.3	6	-	-	-	
PC 8B *	100x100	3	4	21.5	-	-	21	20.9	20.7	20.4	20	19.5	18.8	17.8	16.5	15	13.5	11.2	9	-	-	-	
PC 8A *	100x100	4	5.5	24.5	-	-	24	23.8	23.5	23.3	23	22.5	21.8	20.8	19.5	18.3	16.8	15	13	-	-	-	
PC 625B *	100x100	5.5	7.5	23	-	-	-	-	-	-	-	-	-	-	21.3	20.9	20.3	19.7	19	17.5	16.7	13.7	
PC 625A *	100x100	7.5	10	27	-	-	-	-	-	-	-	-	-	-	26	25.6	25.2	24.8	24.5	23	22.5	20	
PC 660D *	100x100	9.2	12.5	33	-	-	-	-	-	-	-	-	-	-	31.5	31	30.5	30	28	27.1	24	21.5	
PC 660C *	100x100	11	15	36	-	-	-	-	-	-	-	-	-	-	34.5	34	33.5	33	31.5	30.8	28	25.5	
PC 660B *	100x100	15	20	42	-	-	-	-	-	-	-	-	-	-	41	40.7	40.4	40	38.5	37.8	35	33	
PC 660A *	100x100	18.5	25	49	-	-	-	-	-	-	-	-	-	-	48	47.7	47.4	47	46	45	42	41	

\* = Cast iron impeller/Impulsor en fundición/Roue en fonte

**PERFORMANCE CURVE/CURVA DE RENDIMIENTO/COURBE DE PERFORMANCE**

60 Hz n=3500 1/min

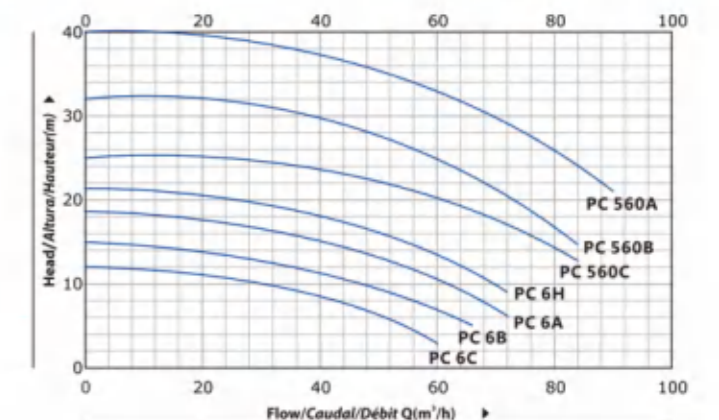
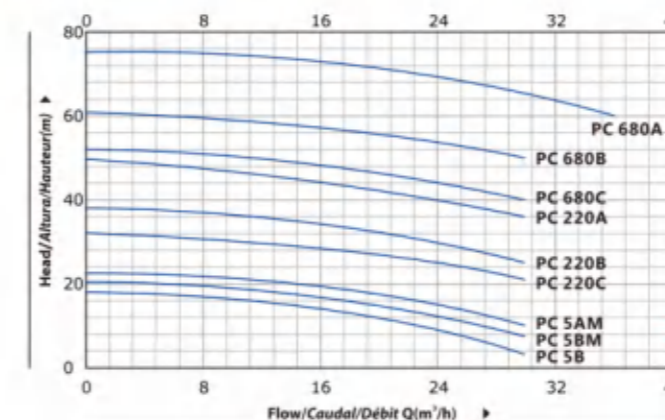

**PERFORMANCE CURVE/CURVA DE RENDIMIENTO/COURBE DE PERFORMANCE**

60Hz n=3500 r/min

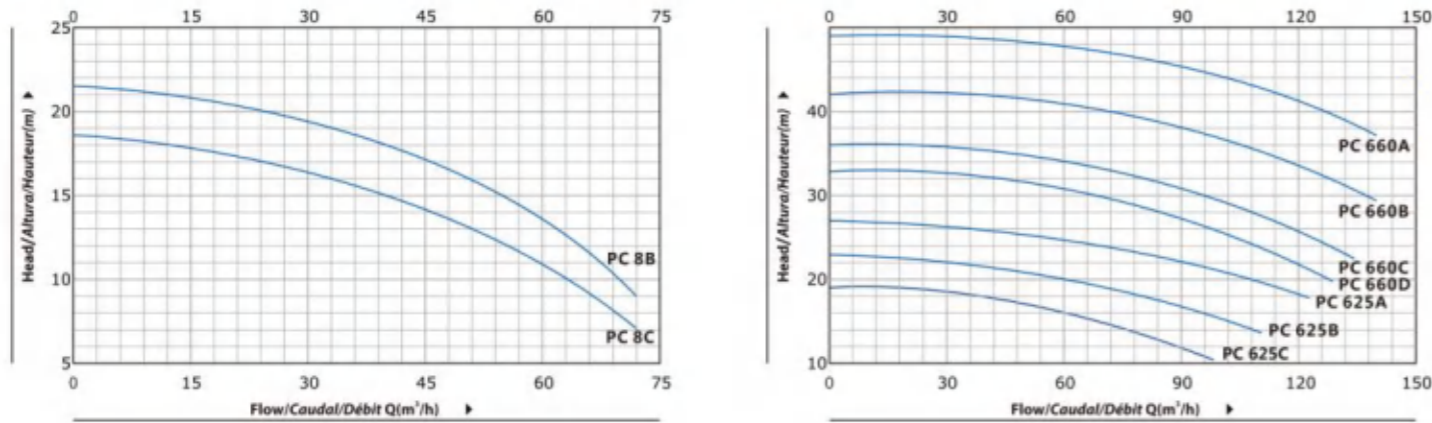
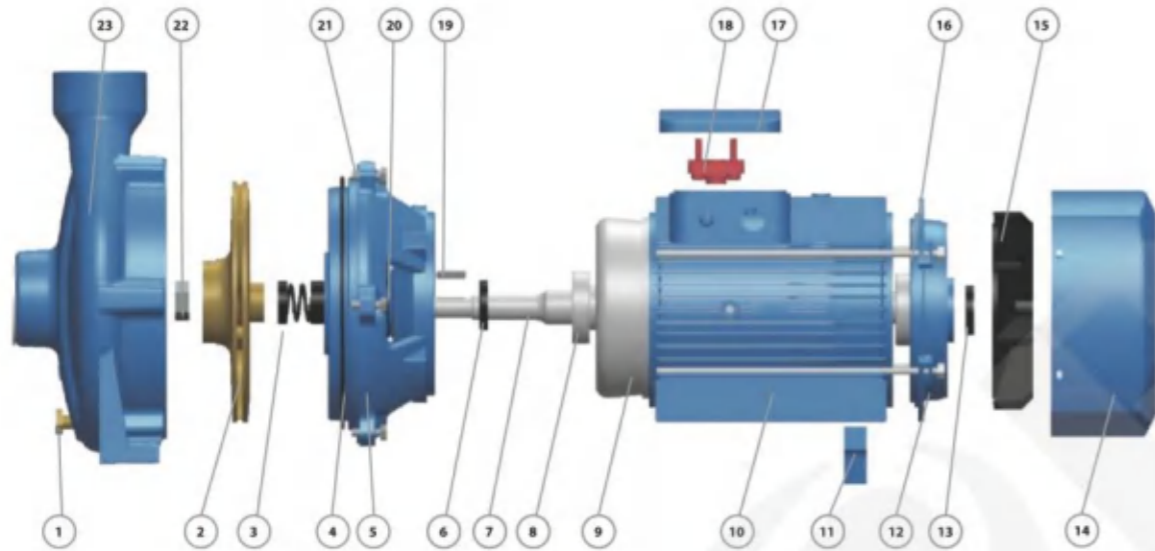
**MATERIAL DESCRIPTION/DESCRIPCIÓN DE MATERIAL/DESCRIPTION DU MATÉRIEL**

No.	Description Descripción	Material Matériel	No.	Description Descripción	Material Matériel	No.	Description Descripción	Material Matériel
1	Release Valve Tapón Cebado Soupape de décharge	Brass Bronce Laiton	9	Wound Stator/Rotor Estator/Rotor Stator/Rotor	Silicon Steel/Copper Silicio-Cobre Silicium-Cuivre	17	Terminal Box Caja Bornas Boîte Bornes	Aluminum Aluminio Aluminium
2	Impeller Impulsor Roue	Brass Bronce Laiton	10	Motor Case Cuerpo Motor Boîtier Moteur	Aluminum Aluminio Aluminium	18	Terminal Board Tablero Bornas Bornier	Plastic Plástico Plastique
3	Mechanical Seal Cierre Mecánico Sceller	SiC/Carbon/SS304 SiC/Grafito/Inox304 SiC/Carbon/Inox304	11	Support Foot Soporte Pie Pied support	Plastic Plástico Plastique	19	Impeller Key Chaveta Clé	Iron Hierro Le fer
4	O-ring Junta Tórica Joint Torique	Rubber Caucho Caoutchouc	12	Back Cover Tapa Trasera Capot Arrière	Cast Iron Fundición Fonte	20	Water Deflector Deflector Déflecteur	Rubber Caucho Caoutchouc
5	Connection Conexión Lien	Cast Iron Fundición Fonte	13	Reinforced Seal Sello Reforzado Sceller	Rubber Caucho Caoutchouc	21	Connection Bolt Perno Boulon	Steel Acero Acier
6	Reinforced Seal Sello Reforzado Sceller	Rubber Caucho Caoutchouc	14	Fan Cover Tapa Capot	Aluminum Aluminio Aluminium	22	Impeller Nut Nuez Noix	Galvanized Steel Acero Galvanizado Acier Galvanisé
7	Shaft Eje Arbre	SS304-45# Steel Inox304-Hierro Inox304-Acier	15	Fan Ventilador Ventilateur	Plastic Plástico Plastique	23	Pump Case Cuerpo de Bomba Boîtier de pompe	Cast Iron Fundición Fonte
8	Bearing Rodamiento Palier	Ball Bearing Bola Rodamiento Palier Balle	16	Through Bolt Perno Boulon	Steel Acero Acier			

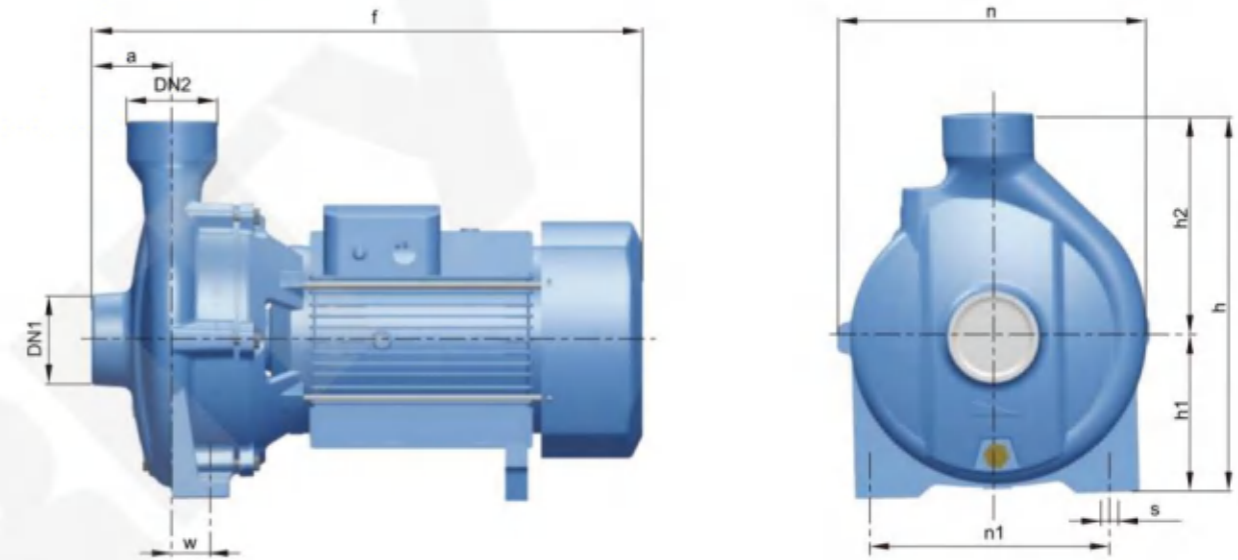
**DIMENSIONS AND WEIGHT/DIMENSIONES Y PESOS/DIMENSIONS ET POIDS**

MODEL/MODELO/MODÈLE		DIMENSIONS/DIMENSIONES/DIMENSIONS mm											kg	
Single-phase Monofásico Monophasé	Three-phase Trifásico Triphasé	DN1	DN2	a	f	h	h1	h2	n	n1	w	s	1~	3~
PC 5B	PC 5B	50	50	51	398	265	105	160	206	160	1	11	18	17
PC 5BM	PC 5BM	50	50	51	398	265	105	160	206	160	1	11	19.9	18.9
PC 5AM	PC 5AM	50	50	51	398	265	105	160	206	160	1	11	21.9	20.9
PC 220C	PC 220C	50	50	75	472	322	132	190	245	165	40	14	29.5	28.5
-	PC 220B	50	50	75	472	322	132	190	245	165	40	14	-	32.3
-	PC 220A	50	50	75	472	322	132	190	245	165	40	14	-	41
-	PC 680C	50	50	75	535	335	140	195	273	190	40	14	-	42
-	PC 680B	50	50	75	535	335	140	195	273	190	40	14	-	47
-	PC 680A	50	50	75	535	335	140	195	273	190	40	14	-	51
PC 6C	PC 6C	80	80	68	435	317	120	197	240	190	6	12	25	24
PC 6B	PC 6B	80	80	68	435	317	120	197	240	190	6	12	26.5	25.5
PC 6A	PC 6A	80	80	68	435	317	120	197	240	190	6	12	27.7	26.7
-	PC 6H	80	80	68	435	317	120	197	240	190	6	12	-	35
-	PC 560C	80	80	79	578	372	163	209	263	212	32	16	-	52
-	PC 560B	80	80	79	578	372	163	209	263	212	32	16	-	64
-	PC 560A	80	80	79	578	372	163	209	263	212	32	16	-	71
PC 8C	PC 8C	100	100	70	482	322	120	202	245	190	30	14	31	30
-	PC 8B	100	100	70	482	322	120	202	245	190	30	14	-	35
-	PC 8A	100	100	70	482	322	120	202	245	190	30	14	-	40
-	PC 625B	100	100	85	593	373	163	210	267	212	32	16	-	68
-	PC 625A	100	100	85	593	373	163	210	267	212	32	16	-	74
-	PC 660D	100	100	85	605	415	186	229	305	222	49	16	-	90
-	PC 660C	100	100	85	605	415	186	229	305	222	49	16	-	106
-	PC 660B	100	100	85	605	415	186	229	305	222	49	16	-	134
-	PC 660A	100	100	85	605	415	186	229	305	222	49	16	-	155



## P2C

### Double impeller centrifugal pump Bomba centrífuga con doble impulsores Pompe centrifuge à double roue



#### MODEL CODE/CÓDIGO MODELO/CODE MODÈLE

For example/Por ejemplo/Par exemple

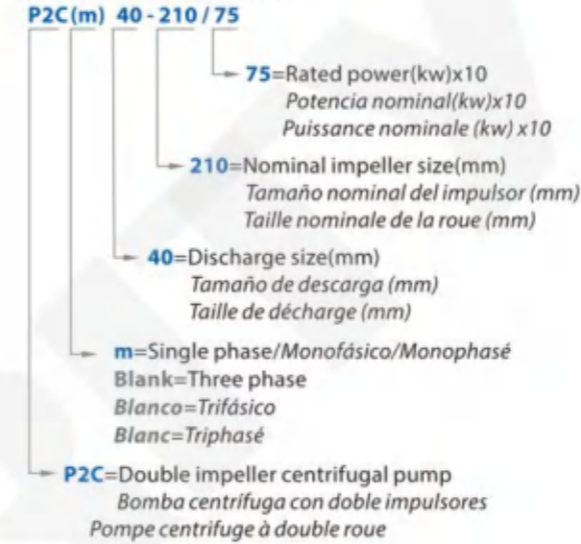

60Hz n=3500 r/min

#### NEW/NUEVO/NOUVEAU

##### DESCRIPTION/DESCRIPCIONES/DESCRIPTION

- Double brass impeller pump in thread port design
- Complete range with a full series of double impeller pump
- Pump case with high-strength alloy steel HT500
- YE3 high efficient motor, with protection IP55 class F
- Shaft in stainless steel AISI 304
- Quality NSK bearing, wear resistance mechanical seal
- Used for any high pressure requirement
- *Bomba doble impulsor de latón en diseño de puerto de rosca*
- *Gama completa con una serie completa de bomba doble impulsor*
- *Caja de bomba con acero aleado de alta resistencia HT500*
- *Motor de alta eficiencia YE3, con protección IP55 clase F*
- *Eje en acero inoxidable 304*
- *Rodamiento de marca NSK y cierre mecánico personalizado*
- *Se utiliza para cualquier requisito de alta presión.*
- *Pompe à double turbine en laiton dans la conception*
- *Gamme complète avec une série complète pompes à double roue*
- *Carter de pompe en acier allié haute résistance HT500*
- *Moteur haute efficacité YE3, avec protection IP55 classe F*
- *Arbre en acier inoxydable 304*
- *Roulement NSK qualité, joint mécanique de résistance à l'usure*
- *Utilisé pour toute exigence de haute pression*

#### USING LIMITS/LÍMITES UTILIZACIÓN/UTILISATION LIMITES

- Liquid temperature between -10°C and +120°C
- Ambient temperature between 0°C and +50°C
- Max. working pressure **20 bar/Continuo S1**
- *Temperatura del líquido de -10 °C hasta +120 °C*
- *Temperatura ambiente de 0 °C hasta +50 °C*
- *Presión máxima 20 bar/Continuo S1*
- *Température du liquide entre -10 °C et +120 °C*
- *Température ambiante entre 0 °C et +50 °C*
- *Max. pression de service 20 bar/Continu S1*

#### APPLICATIONS/APLICACIONES/APPLICATIONS

- For conveying water and other liquids similar to water in physical and chemical properties, suitable for energy, metallurgy, chemical, textile, paper and hotels and other boiler water pressurization transport and urban heating system circulation pump.
- *Para el transporte de agua y otros líquidos similares al agua en propiedades físicas y químicas, adecuado para la energía, metalurgia, química, textil, papel y hoteles y otras calderas de presurización de agua de transporte y sistema de calefacción urbana bomba de circulación.*
- *Pour le transport de l'eau et d'autres liquides semblables à l'eau dans les propriétés physiques et chimiques, approprié à l'énergie, à la métallurgie, à la chimie, au textile, au papier et aux hôtels et à d'autres transports de pressurisation d'eau de chaudière et pompe de circulation de système de chauffage Urbain.*

MODEL MODELO MODÈLE	DN mm	Power Potencia Puissance kw   hp		Q=DELIVERY/CAUDAL/DÉBIT																						
				l/min m³/h	H=Head/Altura/Hauteur(m)																					
					40	50	60	70	80	90	100	110	120	140	160	180	200	250	300	350	400	450				
P2C 25-140/11	32x25	1.1	1.5	54	47.5	44.5	41	37	33	28	22	-	-	-	-	-	-	-	-	-	-	-	-	-	-	-
P2C 25-160/11	32x25	1.1	1.5	47	44	42	40	38	35	33	30	27	24	-	-	-	-	-	-	-	-	-	-	-	-	-
P2C 25-160/15	32x25	1.5	2	58	54	53	51	49	47	45	43	40	37	30	-	-	-	-	-	-	-	-	-	-	-	-
P2C 25-160/22	32x25	2.2	3	68	64.5	63	62	60	58	56	54	51	48	41	32	-	-	-	-	-	-	-	-	-	-	-
P2C 32-200/30	40x32	3	4	70	-	-	-	-	63	62	60.5	59	57	55	52	49.5	46.5	36	-	-	-	-	-	-	-	-
P2C 32-200/40	40x32	4	5.5	85	-	-	-	-	77	76	75	74	72	69	66	62	58	49	-	-	-	-	-	-	-	-
P2C 32-210/55	50x32	5.5	7.5	94	-	-	-	-	91	90	89	87	85	83	79	75	70	56	-	-	-	-	-	-	-	-
P2C 32-210/75	50x32	7.5	10	112	-	-	-	-	110	109	108	107	105	102	99	94	89	74	-	-	-	-	-	-	-	-
P2C 40-210/55	50x40	5.5	7.5	94	-	-	-	-	91	90	89	87	85	83	79	75	70	56	-	-	-	-	-	-	-	-
P2C 40-210/75	50x40	7.5	10	112	-	-	-	-	110	109	108	107	105	102	99	94	89	74	-	-	-	-	-	-	-	-
P2C 50-180/40	50x50	4	5.5	62	-	-	-	-	59	58	57	56	55	55	50	48	44	36	31	23	-	-	-	-	-	-
P2C 50-180/55	50x50	5.5	7.5	72	-	-	-	-	69	68	67	66	65	65	60	58	54	46	41	33	-	-	-	-	-	-
P2C 50-180/75	50x50	7.5	10	84	-	-	-	-	81	80	79	78	76	75	72	72	66	58	53	45	-	-	-	-	-	-
P2C 40-200/92	50x40	9.2	12.5	97	-	-	-	-	-	-	-	-	-	-	91.5	91	90	88	85	80	74	68	61	-	-	-
P2C 40-200/110	50x40	11	15	105	-	-	-	-	-	-	-	-	-	-	100	99	98	97	93	88	83	76	69	-	-	-
P2C 50-200/92	50x50	9.2	12.5	97	-	-	-	-	-	-	-	-	-	-	91.5	91	90	88	85	80	74	68	61	-	-	-
P2C 50-200/110	50x50	11	15	105	-	-	-	-	-	-	-	-	-	-	100	99	98	97	93	88	83	76	69	-	-	-
P2C 40-250/130	50x40	13	17.5	120	-	-	-	-	-	-	-	-	-	-	114	113	112	110	107	103	98	91	82	-	-	-
P2C 40-250/150	50x40	15	20	130	-	-	-	-	-	-	-	-	-	-	124	123	122	120	117	113	108	102	92	-	-	-
P2C 40-250/185	50x40	18.5	25	145	-	-	-	-	-	-	-	-	-	-	139	138	137	136	131	126	121	114	107	-	-	-
P2C 40-250/220	50x40	22	30	160	-	-	-	-	-	-	-	-	-	-	155	153	152	151	146	141	135	130	122	-	-	-
P2C 50-250/130	50x50	13	17.5	120	-	-	-	-	-	-	-	-	-	-	114	113	112	110	107	103	98	91	82	-	-	-
P2C 50-250/150	50x50	15	20	130	-	-	-	-	-	-	-	-	-	-	124	123	122	120	117	113	108	102	92	-	-	-
P2C 50-250/185	50x50	18.5	25	145	-	-	-	-	-	-	-	-	-	-	139	138	137	136	131	126	121	114	107	-	-	-
P2C 50-250/220	50x50	22	30	160	-	-	-	-	-	-	-	-	-	-	155	153	152	151	146	141	135	130	122	-	-	-

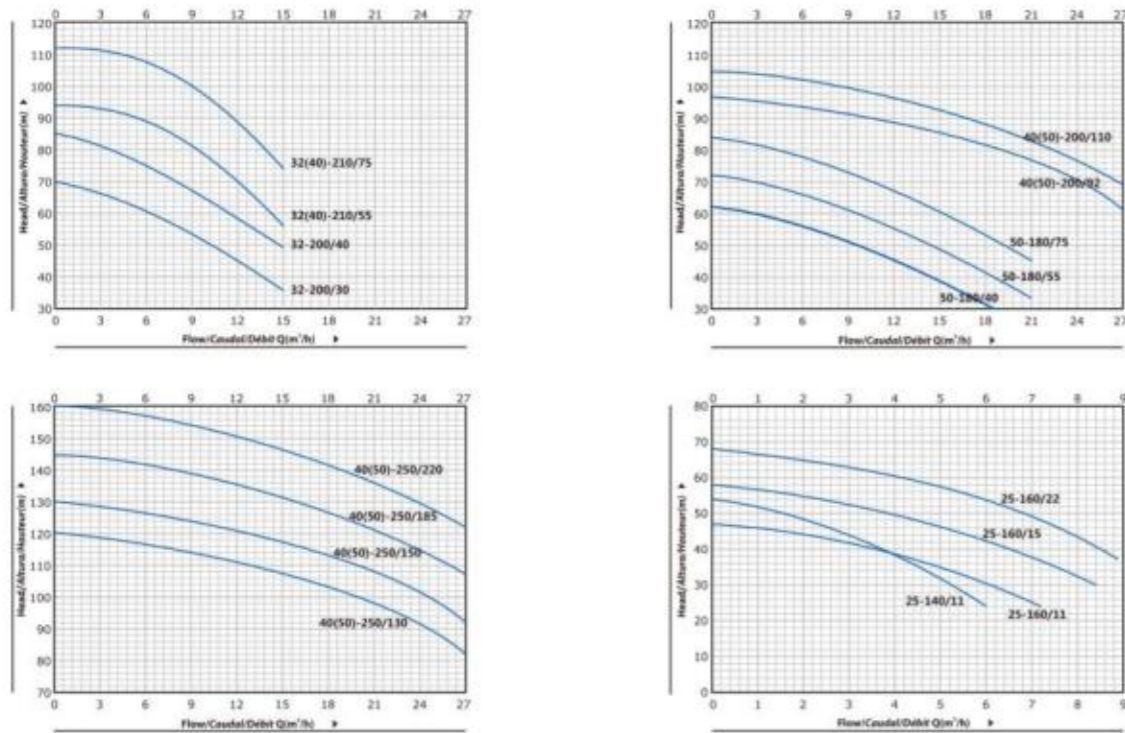

## DIMENSIONS AND WEIGHT/DIMENSIONES Y PESOS/DIMENSIONS ET POIDS

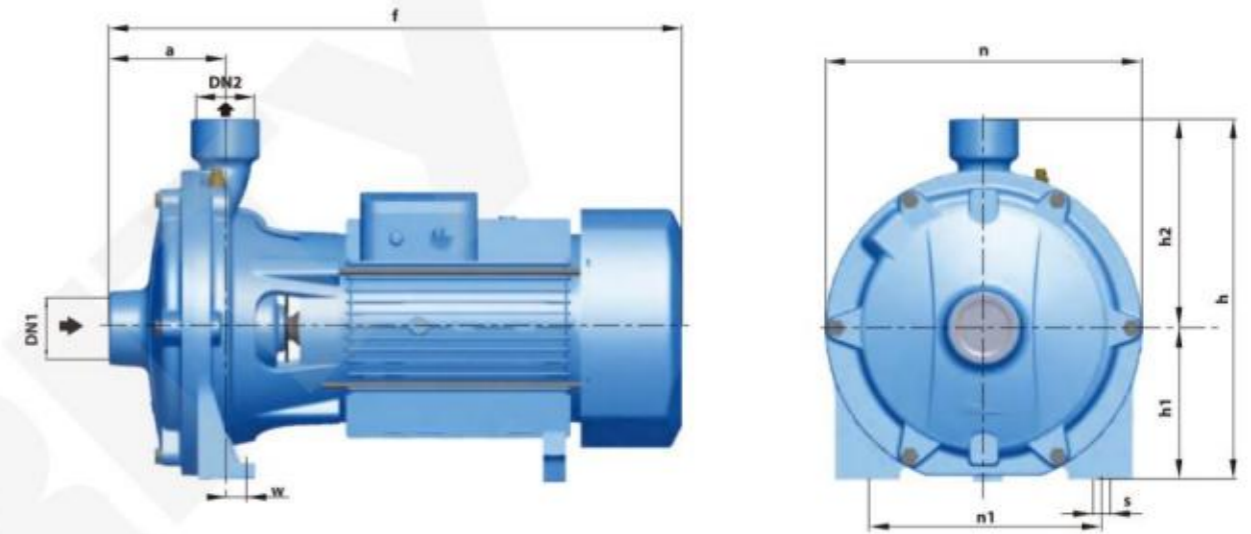

## MATERIAL DESCRIPTION/DESCRIPCIÓN DE MATERIAL/DESCRIPTION DU MATÉRIEL

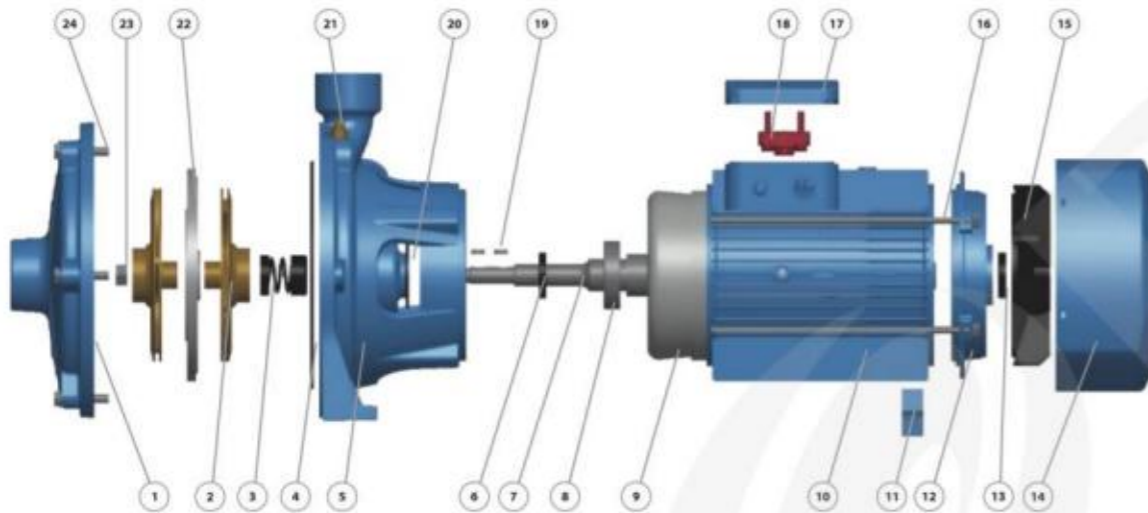

No.	Description Descripción	Material Matériel	No.	Description Descripción	Material Matériel	No.	Material Matériel	Material Matériel
1	Pump Case Cuerpo Boîtier	Cast iron Fundición Fonte	9	Wound Stator/Rotor Estator/Rotor	Silicon Steel/Copper Silicio-Cobre Silicium-Cuivre	17	Terminal Box Caja Bornas Boîte Bornes	Aluminum Aluminio Aluminium
2	Impeller Impulsor Roue	Brass Bronce Laiton	10	Motor Case Cuerpo Motor Boîtier Moteur	Aluminum Aluminio Aluminium	18	Terminal Board Tablero Bornas Bornier	Plastic Plástico Plastique
3	Mechanical Seal Cierre Mecánico Sceller	SiC/Carbon/SS304 SiC-Carbitto-Inox304 SiC/Carbon/Inox304	11	Support Foot Soporte Pie Pied support	Plastic Plástico Plastique	19	Impeller Key Chaveta Clé	Iron Hierro Le fer
4	O-ring Junta Tórica Joint Torique	Rubber Caucho Caoutchouc	12	Back Cover Tapa Trasera Capot Arrière	Cast iron Fundición Fonte	20	Water Deflector Deflector Déflecteur	Rubber Caucho Caoutchouc
5	Connection Conexión Lien	Cast iron Fundición Fonte	13	Reinforced Seal Sello Reforzado Sceller	Rubber Caucho Caoutchouc	21	Release Valve Tapón Cebado Soupape de décharge	Brass Bronce Laiton
6	Reinforced Seal Sello Reforzado Sceller	Rubber Caucho Caoutchouc	14	Fan Cover Tapa Capot	Aluminum Aluminio Aluminium	22	Diffuser Difusor Diffuseur	Cast iron Fundición Fonte
7	Shaft Eje Arbre	SS304-45# Steel Inox 304-Hier Inox304-Acier	15	Fan Ventilador Ventilateur	Plastic Plástico Plastique	23	Impeller Nut Nuez Noix	Galvanized Steel Acero Galvanizado Acier Galvanisé
8	Bearing Rodamiento Palier	Ball Bearing Bola Rodamiento Palier Balle	16	Through Bolt Perno Boulon	Steel Acero Acier	24	Connection Bolt Perno Boulon de connexion	Steel Acero Acier

MODEL/MODELO/MODÈLE		DIMENSIONS/DIMENSIONES/DIMENSIONS mm											kg	
Single-phase Monofásico Monophasé	Three-phase Trifásico Triphasé	DN1	DN2	a	f	h	h1	h2	n	n1	w	s	1-	3-
25-140/11	25-140/11	32	25	84	420	232	95	137	200	150	19	10	19.8	18.8
25-160/11	25-160/11	32	25	84	420	270	110	160	225	172	19	11	19.8	18.8
25-160/15	25-160/15	32	25	84	420	270	110	160	225	172	19	11	24.2	23.2
25-160/22	25-160/22	32	25	84	420	270	110	160	225	172	19	11	25.5	24.5
-	32-200/30	40	32	103	503	317	132	185	280	205	16	14	39	38
-	32-200/40	40	32	103	503	317	132	185	280	205	16	14	-	43
-	32-210/55	50	32	108	565	352	155	197	300	246	16	14	-	54
-	32-210/75	50	32	108	565	352	155	197	300	246	16	14	-	61
-	50-180/40-55-75	50	50	108	565	352	155	197	300	246	16	14	-	49/54/61
-	40-210/55-75	50	40	108	565	352	155	197	300	246	16	14	-	54/61
-	40-200/92	50	40	119	615	355	150	205	304	215	11	14	-	89
-	40-200/110	50	40	119	615	355	150	205	304	215	11	14	-	90
-	50-200/92	50	50	119	615	355	150	205	304	215	11	14	-	89
-	50-200/110	50	50	119	615	355	150	205	304	215	11	14	-	90
-	40-250/130	50	40	124	740	407	170	237	357	270	17	14	-	110
-	40-250/150	50	40	124	740	407	170	237	357	270	17	14	-	120
-	40-250/185	50	40	124	740	407	170	237	357	270	17	14	-	130
-	40-250/220	50	40	124	740	407	170	237	357	270	17	14	-	140
-	50-250/130	50	50	124	740	407	170	237	357	270	17	14	-	110
-	50-250/150	50	50	124	740	407	170	237	357	270	17	14	-	120
-	50-250/185	50	50	124	740	407	170	237	357	270	17	14	-	130
-	50-250/220	50	50	124	740	407	170	237	357	270	17	14	-	140



# PZ

**Stainless steel standard pump**  
**Bomba normalizada en acero inoxidable**  
**Pompe standard en acier inoxydable**



## NEW/NUEVO/NOUVEAU

### DESCRIPTION/DESCRIPCIONES/DESCRIPTION

- Stainless steel 304 standard pump design
  - All wetted parts are in stainless steel 304
  - Both square motor & round motor available
  - Stainless steel AISI 316 material as request
  - Back pull-out design without removing the pipes
  - Quality NSK bearing, wear resistance mechanical seal
  - Available to delivery some impure liquid
- Diseño de bomba estándar de acero inoxidable 304
  - Todas las partes húmedas son de acero inoxidable 304.
  - Motor cuadrado y motor redondo disponibles.
  - Material de acero inoxidable 316 según pedido
  - Diseño de extracción posterior sin quitar las tuberías
  - Rodamiento de marca NSK y cierre mecánico personalizado
  - Disponible para la entrega de algún líquido impuro
- Conception de pompe standard en acier inoxydable 304
  - Toutes les pièces en contact avec le fluide sont en inox304
  - Moteur carré et moteur rond disponibles
  - Matériau en acier inoxydable 316 comme demande
  - Conception arrière coulissante sans retirer les tuyaux
  - Roulement NSK qualité, joint mécanique de résistance à l'usure
  - Disponible pour la livraison de liquide impur

## USING LIMITS/LÍMITES UTILIZACIÓN/UTILISATION LIMITES

- Liquid temperature between **-10°C** and **+120°C**
  - Ambient temperature between **0°C** and **+50°C**
  - Max. working pressure **16 bar/Continuous S1**
- Temperatura del líquido de **-10 °C** hasta **+120 °C**
  - Temperatura ambiente de **0 °C** hasta **+50 °C**
  - Presión máxima **16 bar/Continuo S1**
- Température du liquide entre **-10 °C** et **+120 °C**
  - Température ambiante entre **0 °C** et **+50 °C**
  - Max. pression de service **16 bar/Continu S1**

## APPLICATIONS/APLICACIONES/APPLICATIONS

- Transport does not contain solid particles, suitable for pressurized transport of corrosive media, and places requiring clean water quality
- El transporte no contiene partículas sólidas, adecuadas para el transporte presurizado de medios corrosivos, y lugares que requieren agua de calidad limpia
- Le Transport ne contient pas de particules solides, convient au Transport sous pression de milieux corrosifs et aux endroits exigeant une qualité d'eau propre

## MODEL CODE/CÓDIGO MODELO/CODE MODÈLE

For example/ Por ejemplo/ Par exemple

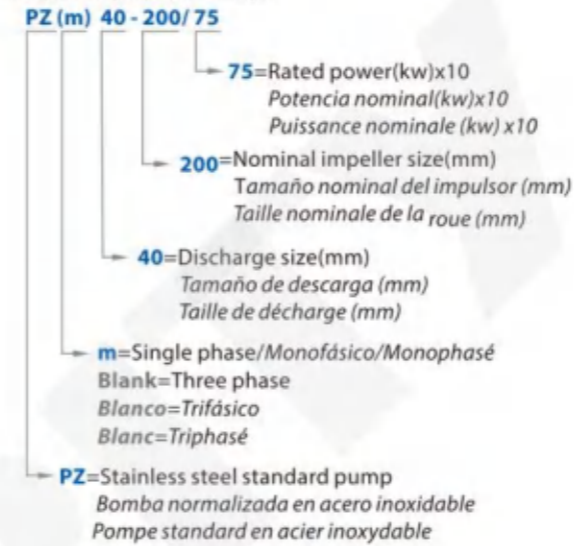

60Hz n=3500 r/min

MODEL MODELO MODÈLE	DN mm	Power Potencia Puissance		Q=DELIVERY/CAUDAL/DÉBIT																																					
		kw	hp	l/min		150		200		300		333		400		600		700		900		1200		1900		2100		2200		2300		2500		3400		3600		3800		4000	
				m <sup>3</sup> /h	0	9	12	18	20	24	36	42	54	72	114	126	132	138	150	204	216	228	240	H=Head/Altura/Hauteur(m)																	
PZ 32-160/11	50x32	1.1	1.5	22.5	19.9	18.4	14.1	12	-	-	-	-	-	-	-	-	-	-	-	-	-	-	-	-	-	-	-	-	-	-	-	-	-	-	-	-	-	-	-		
PZ 32-160/15	50x32	1.5	2	29.5	26.5	24.5	19.2	17	-	-	-	-	-	-	-	-	-	-	-	-	-	-	-	-	-	-	-	-	-	-	-	-	-	-	-	-	-	-	-		
PZ 32-160/22	50x32	2.2	3	37	34	32	27	25	-	-	-	-	-	-	-	-	-	-	-	-	-	-	-	-	-	-	-	-	-	-	-	-	-	-	-	-	-	-	-		
PZ 32-200/30	50x32	3	4	44	40	37.5	31	28	-	-	-	-	-	-	-	-	-	-	-	-	-	-	-	-	-	-	-	-	-	-	-	-	-	-	-	-	-	-	-		
PZ 32-200/40	50x32	4	5.5	55	52	49.5	43.5	40.5	37	-	-	-	-	-	-	-	-	-	-	-	-	-	-	-	-	-	-	-	-	-	-	-	-	-	-	-	-	-	-		
PZ 32-200/55	50x32	5.5	7.5	70.5	67.5	65	58.5	55	51	-	-	-	-	-	-	-	-	-	-	-	-	-	-	-	-	-	-	-	-	-	-	-	-	-	-	-	-	-	-		
PZ 40-125/15	65x40	1.5	2	20	-	19	17.6	17	15.7	10.3	7	-	-	-	-	-	-	-	-	-	-	-	-	-	-	-	-	-	-	-	-	-	-	-	-	-	-	-	-		
PZ 40-125/22	65x40	2.2	3	26.5	-	25.5	24	23.5	22	16.4	13	-	-	-	-	-	-	-	-	-	-	-	-	-	-	-	-	-	-	-	-	-	-	-	-	-	-	-	-		
PZ 40-160/30	65x40	3	4	31	-	29.5	27.5	27	25.5	20	17	-	-	-	-	-	-	-	-	-	-	-	-	-	-	-	-	-	-	-	-	-	-	-	-	-	-	-	-		
PZ 40-160/40	65x40	4	5.5	40	-	38.5	37	36	34.5	29	25.5	-	-	-	-	-	-	-	-	-	-	-	-	-	-	-	-	-	-	-	-	-	-	-	-	-	-	-	-		
PZ 40-200/55	65x40	5.5	7.5	47	-	45.5	44	43	41	35	31	-	-	-	-	-	-	-	-	-	-	-	-	-	-	-	-	-	-	-	-	-	-	-	-	-	-	-	-		
PZ 40-200/75	65x40	7.5	10	58	-	57	55.5	55	53.5	47.5	44	-	-	-	-	-	-	-	-	-	-	-	-	-	-	-	-	-	-	-	-	-	-	-	-	-	-	-	-		
PZ 40-200/110	65x40	11	15	72	-	71	70	70	68.5	63	59	-	-	-	-	-	-	-	-	-	-	-	-	-	-	-	-	-	-	-	-	-	-	-	-	-	-	-	-	-	
PZ 50-125/22	65x50	2.2	3	19	-	-	-	-	17.5	14.9	13.4	10.7	-	-	-	-	-	-	-	-	-	-	-	-	-	-	-	-	-	-	-	-	-	-	-	-	-	-	-		
PZ 50-125/30	65x50	3	4	22	-	-	-	-	20.5	18.4	17	14.4	8	-	-	-	-	-	-	-	-	-	-	-	-	-	-	-	-	-	-	-	-	-	-	-	-	-	-		
PZ 50-125/40	65x50	4	5.5	26.5	-	-	-	-	26	24	22.5	20.5	14	-	-	-	-	-	-	-	-	-	-	-	-	-	-	-	-	-	-	-	-	-	-	-	-	-	-		
PZ 50-160/55	65x50	5.5	7.5	33	-	-	-	-	31	28.5	27	24.5	18	-	-	-	-	-	-	-	-	-	-	-	-	-	-	-	-	-	-	-	-	-	-	-	-	-	-		
PZ 50-160/75	65x50	7.5	10	40	-	-	-	-	38.5	36	35	32.5	26	-	-	-	-	-	-	-	-	-	-	-	-	-	-	-	-	-	-	-	-	-	-	-	-	-	-		
PZ 50-200/92	65x50	9.2	12.5	53	-	-	-	-	49	47.5	44.5	34	-	-	-	-	-	-	-	-	-	-	-	-	-	-	-	-	-	-	-	-	-	-	-	-	-	-	-		
PZ 50-200/110	65x50	11	15	59	-	-	-	-	55	54	51	42	-	-	-	-	-	-	-	-	-	-	-	-	-	-	-	-	-	-	-	-	-	-	-	-	-	-	-		
PZ 50-200/150	65x50	15	20	72	-	-	-	-	69	68	65	57	-	-	-	-	-	-	-	-	-	-	-	-	-	-	-	-	-	-	-	-	-	-	-	-	-	-	-		
PZ 65-125/40	80x65	4	5.5	22.2	-	-	-	-	19.8	19	17.3	13.5	6.3	-	-	-	-	-	-	-	-	-	-	-	-	-	-	-	-	-	-	-	-	-	-	-	-	-	-		
PZ 65-125/55	80x65	5.5	7.5	27	-	-	-	-	24	22.2	18.5	10.8	8	-	-	-	-	-	-	-	-	-	-	-	-	-	-	-	-	-	-	-	-	-	-	-	-	-	-		
PZ 65-125/75	80x65	7.5	10	32	-	-	-	-	29.5	27.8	24	16.1	13.4	12	-	-	-	-	-	-	-	-	-	-	-	-	-	-	-	-	-	-	-	-	-	-	-	-	-		
PZ 65-160/92	80x65	9.2	12.5	36.5	-	-	-	-	34.5	32.8	29	21.1	18.3	16.8	-	-	-	-	-	-	-	-	-	-	-	-	-	-	-	-	-	-	-	-	-	-	-	-	-		
PZ 65-160/110	80x65	11	15	40.5	-	-	-	-	38.5	37.1	33.5	25.8	23	21.5	20	-	-	-	-	-	-	-	-	-	-	-	-	-	-	-	-	-	-	-	-	-	-	-	-		
PZ 65-200/150	80x65	15	20	53.5	-	-	-	-	51	49	44.5	35.3	31.8	30	-	-	-	-	-	-	-	-	-	-	-	-	-	-	-	-	-	-	-	-	-	-	-	-	-		
PZ 65-200/185	80x65	18.5	25	60.5	-	-	-	-	58.5	56.5	52	43	39.7	38	36.3	-	-	-	-	-	-	-	-	-	-	-	-	-	-	-	-	-	-	-	-	-	-	-	-		
PZ 65-200/220	80x65	22	30	67	-	-	-	-	65.5	64	60	51	48	46.5	45	-	-	-	-	-	-	-	-	-	-	-	-	-	-	-	-	-	-	-	-	-	-	-	-		
PZ 80-160/110	100x80	11	15	29	-	-	-	-	-	-	-	-	-	-	-	-	-	-	-	-	-	-	-	-	-	-	-	-	-	-	-	-	-	-	-	-	-	-	-		
PZ 80-160/150	100x80	15	20	35	-	-	-	-	-	-	-	-	-	-	-	-	-	-	-	-	-	-	-	-	-	-	-	-	-	-	-	-	-	-	-	-	-	-	-		
PZ 80-160/185	100x80	18.5	25	40	-	-	-	-	-	-	-	-	-	-	-	-	-	-	-	-	-	-	-	-	-	-	-	-	-	-	-	-	-	-	-	-	-	-	-		
PZ 80-200/220	100x80	22	30	50	-	-	-	-	-	-	-	-	-	-	-	-	-	-	-	-	-	-	-	-	-	-	-	-	-	-	-	-	-	-	-	-	-	-	-		
PZ 80-200/300	100x80	30	40	60	-	-	-	-	-	-	-	-	-	-	-	-	-	-	-	-	-	-	-	-	-	-	-	-	-	-	-	-	-	-	-	-	-	-	-		
PZ 80-200/370	100x80	37	50	66	-	-	-	-	-	-	-	-	-	-	-	-	-	-	-	-	-	-	-	-	-	-	-	-	-	-	-	-	-	-	-	-	-	-	-		

## PERFORMANCE CURVE/CURVA DE RENDIMIENTO/COURBE DE PERFORMANCE

60Hz n=3500 r/min

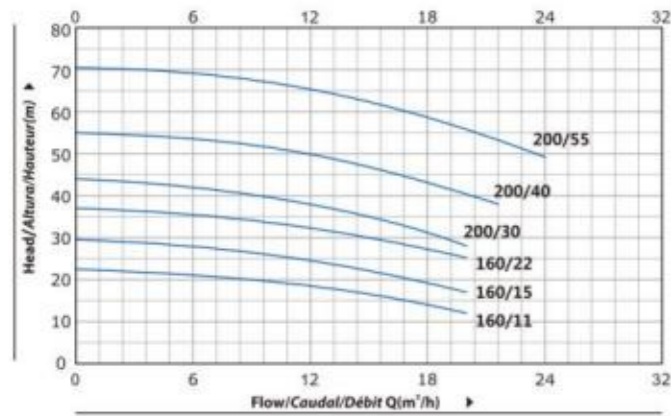

PZ 32

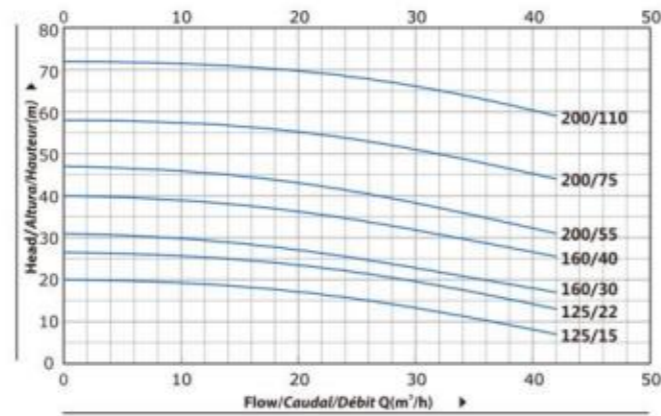

PZ 40

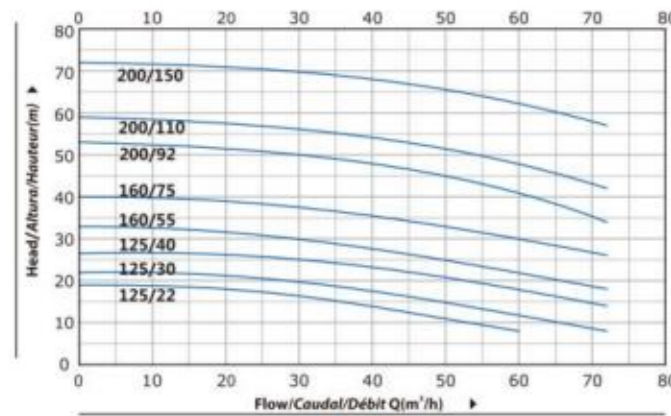

PZ 50

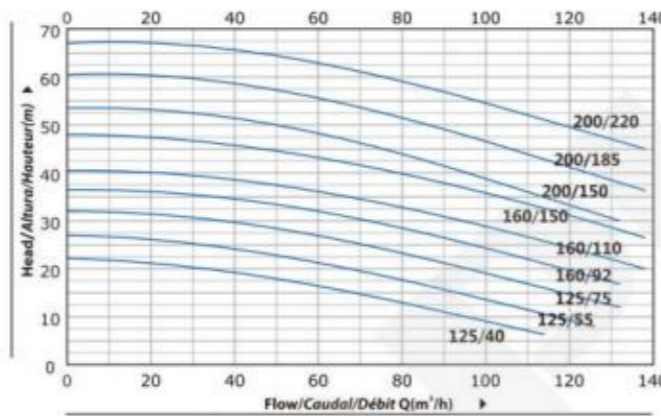

PZ 65

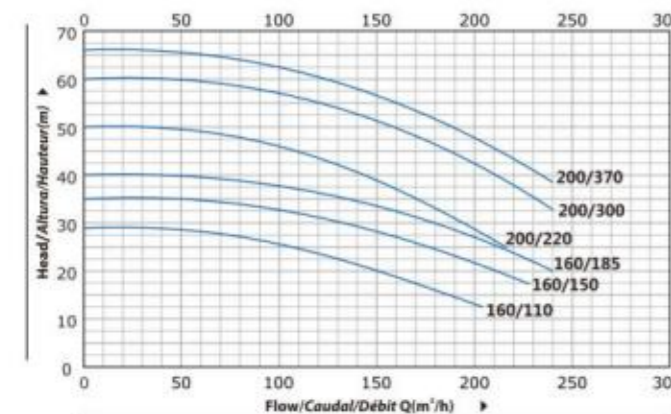

PZ 80

**Back pull-out design**  
 Diseño extraíble hacia atrás  
 Conception arrière coulissante

It allows removal of the motor, the coupling, the cantilever support and the impeller without compromising the housing of the pump body or removing the pipes.

Permite retirar el motor, el acoplamiento, el soporte en voladizo y el impulsor sin comprometer la carcasa del cuerpo de la bomba ni quitar las tuberías.

Il permet le démontage du moteur, de l'accouplement, du support en porte-à-faux et de la roue sans compromettre le logement du corps de pompe ou retirer les tuyaux.

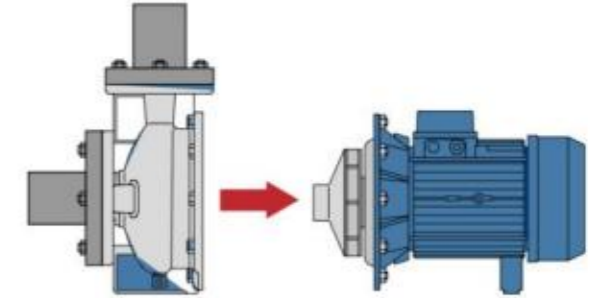
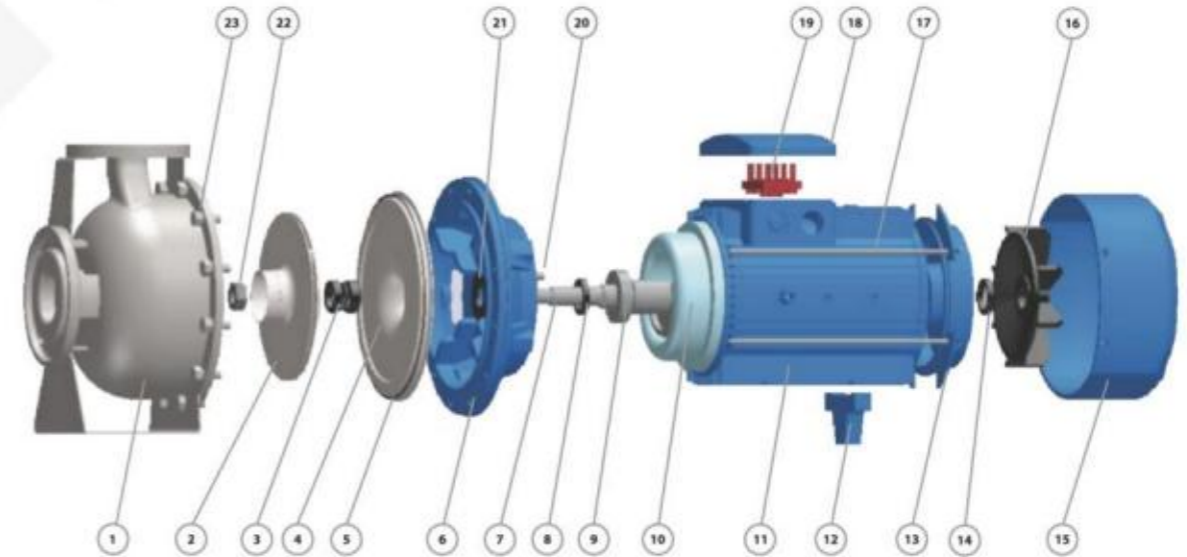
**MATERIAL DESCRIPTION/DESCRIPCIÓN DE MATERIAL/DESCRIPTION DU MATÉRIEL**

No.	Description Descripción Description	Material Material Matériel	No.	Description Descripción Description	Material Material Matériel	No.	Description Descripción Description	Material Material Matériel
1	Pump Case Cuerpo de Bomba Boîtier de pompe	SS304 Inox 304 Inox 304	9	Bearing Rodamiento Palier	Ball Bearing Bola Rodamiento Palier Balle	17	Through Bolt Perno Boulon	Steel Acero Acier
2	Impeller Impulsor Roue	SS304 Inox 304 Inox 304	10	Wound Stator/Rotor Estator/Rotor Stator/Rotor	Silicon/Copper Silicio/Cobre Silicium/Cuivre	18	Terminal Box Caja Bornas Boîte Bornes	Aluminum Aluminio Aluminium
3	Mechanical Seal Cierre Mecánico Sceller	SiC/Carbon/SS304 SiC/Grafito/Inox304 SiC/Carbon/Inox304	11	Motor Case Cuerpo Motor Boîtier Moteur	Aluminum Aluminio Aluminium	19	Terminal Board Tablero Bornas Bornier	Plastic Plástico Plastique
4	Baffle plate Placa de baffle Plaque chicane	SS304 Inox 304 Inox 304	12	Support Foot Soporte Pie Pied support	Plastic Plástico Plastique	20	Impeller Key Chaveta Clé	Iron Hierro Le fer
5	O-ring Junta Tórica Joint Torique	Rubber Caucho Caoutchouc	13	Back Cover Tapa Trasera Capot Arrière	Cast iron Fundición Fonte	21	Water Deflector Deflector Déflecteur	Rubber Caucho Caoutchouc
6	Connection Conexión Lien	Cast Iron Fundición Fonte	14	Reinforced Seal Sello Reforzado Sceller	Rubber Caucho Caoutchouc	22	Impeller Nut Nuez Noix	Galvanized Steel Acero Galvanizado Acier Galvanisé
7	Shaft Eje Arbre	SS304 Inox 304 Inox 304	15	Fan Cover Tapa Capot Capot	Aluminum Aluminio Aluminium	23	Connection Bolt Perno Boulon de connexion	Steel Acero Acier
8	Reinforced Seal Sello Reforzado Sceller	Rubber Caucho Caoutchouc	16	Fan Ventilador Ventilateur	Plastic Plástico Plastique			

## DIMENSIONS AND WEIGHT/DIMENSIONES Y PESOS/DIMENSIONS ET POIDS

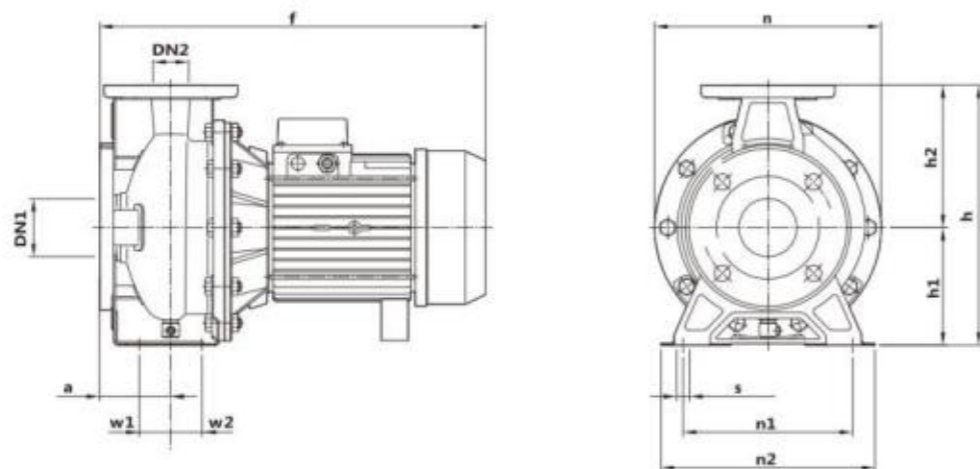

MODEL/MODELO/MODÈLE		DIMENSIONS/DIMENSIONES/DIMENSIONS mm													kg	
Single-phase Monofásico Monophasé	Three-phase Trifásico Triphasé	DN1	DN2	a	f	h	h1	h2	n	n1	n2	w1	w2	s	1~	3~
32-160/11-15	32-160/11-15	50	32	100	493	306	150	156	235	148	175	60	31	15	20.6/23.5	19.6/22.5
32-160/22	32-160/22	50	32	100	493	306	150	156	235	148	175	60	31	15	25.6	24.6
32-200/30	32-200/30-40	50	32	100	538	306	150	156	235	148	175	60	31	15	33.8	32.8/39.5
-	32-200/55	50	32	100	538	306	150	156	235	148	175	60	31	15	-	48.5
40-125/15-22	40-125/15-22	65	40	100	493	306	150	156	235	148	175	60	31	15	21.1/23.7	20.1/22.7
40-160/30	40-160/30-40	65	40	105	542	340	160	180	278	148	175	60	31	15	29	28/35.1
-	40-200/55-75	65	40	105	584	340	160	180	278	148	175	60	31	15	-	48.8/56.2
-	40-200/110	65	40	105	650	340	160	180	235	148	175	60	31	15	-	67.5
50-125/22	50-125/22	65	50	100	428	340	160	180	235	148	175	60	31	15	29.1	28.1
50-125/30	50-125/30-40	65	50	100	493	340	160	180	278	148	175	60	31	15	29.6	28.6/35.2
-	50-160/55-75	65	50	105	584	340	160	180	278	148	175	60	31	15	-	49.1/55.5
-	50-200/92-110	65	50	105	650	365	185	180	278	148	175	60	31	15	-	61.7/67.5
-	50-200/150	65	50	105	768	365	185	180	278	148	175	60	31	15	-	96
-	65-125/40	80	65	100	584	340	160	180	278	148	175	60	31	15	-	40
-	65-125/55-75	80	65	100	584	340	160	180	278	148	175	60	31	15	-	52/58.5
-	65-160/92-110	80	65	113	675	345	160	185	278	148	175	60	31	15	-	67/75.6
-	65-160/150	80	65	113	732	345	160	185	278	148	175	60	31	15	-	93
-	65-200/150-185	80	65	113	793	370	185	185	278	148	175	60	31	15	-	114/127
-	65-200/220	80	65	113	793	370	185	185	278	148	175	60	31	15	-	136
-	80-160/110	100	80	125	700	400	180	220	278	148	175	60	31	15	-	85
-	80-160/150-185	100	80	125	870	400	180	220	278	148	175	60	31	15	-	119/135
-	80-200/220	100	80	125	915	450	200	250	278	148	175	60	31	15	-	185
-	80-200/300-370	100	80	125	985	450	200	250	278	148	175	60	31	15	-	265/285



# PT

## Vertical inline pump Bomba vertical en-línea Pompe en ligne verticale



### MODEL CODE/CÓDIGO MODELO/CODE MODÈLE

For example/ Por ejemplo/ Par exemple

PT (m) 65 - 400 / 75

75=Rated power(kw)x10  
Potencia nominal(kw)x10  
Puissance nominale (kw) x10

400=Maximum head(m)x10  
Altura máxima (m)x10  
Tête maximale (m)x10

65=Discharge size(mm)  
Tamaño de descarga (mm)  
Taille de décharge (mm)

m=Single phase/Monofásico/Monophasé  
Blank=Three phase  
Blanco=Trifásico  
Blanc=Triphasé

PT=Vertical inline pump  
Bomba vertical en-línea  
Pompe en ligne verticale

### NEW/NUEVO/NOUVEAU

#### DESCRIPTION/DESCRIPCIONES/DESCRIPTION

- ◆ Single-stage centrifugal pumps in inline design
  - ◆ With high temperature seal for using in heating systems
  - ◆ YE3 high efficient motor, with protection IP55 class F
  - ◆ Pumpcase with anti-corrosive coating
  - ◆ Galvanized counter flange with bolts, nuts and gaskets
  - ◆ Quality NSK bearing, wear resistance mechanical seal
  - ◆ Compact and proportional design
- ◆ Bombas centrífugas de una etapa en diseño en línea.
  - ◆ Con cierre de alta temperatura para sistemas de calefacción
  - ◆ Motor de alta eficiencia YE3, con protección IP55 clase F
  - ◆ Caja de bomba con revestimiento anticorrosivo
  - ◆ Contrabrida galvanizada con pernos, tuercas y juntas
  - ◆ Rodamiento de marca NSK y cierre mecánico personalizado
  - ◆ El diseño compacto y proporcional
- ◆ Pompes centrifuges à un étage de conception en ligne
  - ◆ Avec garniture haute température pour systèmes de chauffage
  - ◆ Moteur haute efficacité YE3, avec protection IP55 classe F
  - ◆ Boîtier de pompe avec revêtement anti-corrosif
  - ◆ Contre-bride galvanisée avec boulons, écrous et joints
  - ◆ Roulement NSK qualité, joint mécanique de résistance à l'usure
  - ◆ La conception compacte et proportionnelle

### USING LIMITS/LÍMITES UTILIZACIÓN/UTILISATION LIMITES

- ◆ Liquid temperature between **-10°C** and **+120°C**
- ◆ Ambient temperature between **0°C** and **+50°C**
- ◆ Max. working pressure **16 bar/Continuous S1**
- ◆ Temperatura del líquido de **-10 °C** hasta **+120 °C**
- ◆ Temperatura ambiente de **0 °C** hasta **+50 °C**
- ◆ Presión máxima **16 bar/Continuo S1**
- ◆ Température du liquide entre **-10 °C** et **+120 °C**
- ◆ Température ambiante entre **0 °C** et **+50 °C**
- ◆ Max. pression de service **16 bar/Continu S1**

### APPLICATIONS/APLICACIONES/APPLICATIONS

- ◆ For conveying water and other liquids similar to water in physical and chemical properties, suitable for energy, metallurgy, chemical, textile, paper and hotels and other boiler water pressurization transport and urban heating system circulation pump.
- ◆ Para el transporte de agua y otros líquidos similares al agua en propiedades físicas y químicas, adecuado para la energía, metalurgia, química, textil, papel y hoteles y otras calderas de presurización de agua de transporte y sistema de calefacción urbana bomba de circulación.
- ◆ Pour le transport de l'eau et d'autres liquides semblables à l'eau dans les propriétés physiques et chimiques, approprié à l'énergie, à la métallurgie, à la chimie, au textile, au papier et aux hôtels et à d'autres transports de pressurisation d'eau de chaudière et pompe de circulation de système de chauffage Urbain.

60Hz n=3500 r/min

MODEL MODELO MODÈLE	DN mm	Power Potencia Puissance kw hp	Q=DELIVERY/CAUDAL/DÉBIT																			
			l/min	100	150	250	300	400	450	600	700	800	900	1200	1400	1500	1800	2000	2300	3000	3500	
			m <sup>3</sup> /h	6	9	15	18	24	27	36	42	48	54	72	84	90	108	120	138	180	210	
H=Head/Altura/Hauteur(m)																						
PT 50-170/7	★	50x50	0.75	1	17.5	16.7	15	12	9	-	-	-	-	-	-	-	-	-	-	-	-	
PT 50-220/11	★	50x50	1.1	1.5	22	21	19.7	16.5	14.5	9	-	-	-	-	-	-	-	-	-	-	-	
PT 50-250/15	★	50x50	1.5	2	25.4	23.7	22.5	18.5	15.8	-	-	-	-	-	-	-	-	-	-	-	-	
PT 50-310/22	★	50x50	2.2	3	31	29.6	28.5	24.5	22	15	-	-	-	-	-	-	-	-	-	-	-	
PT 50-350/30	★	50x50	3	4	35	34.3	34	28	25.5	19	15	-	-	-	-	-	-	-	-	-	-	
PT 50-410/40	★	50x50	4	5.5	41	-	-	-	38.5	36.2	35	30	25	-	-	-	-	-	-	-	-	
PT 50-460/55	★	50x50	5.5	7.5	46	-	-	-	43.8	41.3	40.1	35	30	-	-	-	-	-	-	-	-	
PT 50-570/75	★	50x50	7.5	10	57	-	-	-	53.6	51.5	50	45	41	36.5	-	-	-	-	-	-	-	
PT 65-140/11		65x65	1.1	1.5	14.7	-	-	-	13.5	11.5	10.1	5.8	-	-	-	-	-	-	-	-	-	
PT 65-180/15		65x65	1.5	2	18.1	-	-	-	17	15	13.9	9.6	6	-	-	-	-	-	-	-	-	
PT 65-240/22		65x65	2.2	3	24.5	-	-	-	23.2	21.5	20.2	16	13	8.3	-	-	-	-	-	-	-	
PT 65-310/30		65x65	3	4	31.8	-	-	-	29.5	27.5	26.3	21.5	17.5	-	-	-	-	-	-	-	-	
PT 65-380/40		65x65	4	5.5	38	-	-	-	36	34	33	28.5	25	20.1	-	-	-	-	-	-	-	
PT 65-320/55		65x65	5.5	7.5	32	-	-	-	-	-	30.6	30	28	26.6	20.5	14.8	-	-	-	-	-	
PT 65-400/75		65x65	7.5	10	40	-	-	-	-	-	38	37	36	34.4	29	24	21	-	-	-	-	
PT 80-190/40		80x80	4	5.5	19	-	-	-	-	-	-	-	-	17.3	16.8	14.5	13	11.8	-	-	-	
PT 80-230/55		80x80	5.5	7.5	23	-	-	-	-	-	-	-	-	21.3	20.9	19	17.5	16.7	13.7	-	-	
PT 80-270/75		80x80	7.5	10	27	-	-	-	-	-	-	-	-	26	25.6	24.5	23	22.5	20	18	-	
PT 80-330/92		80x80	9.2	12.5	33	-	-	-	-	-	-	-	-	31.5	30	28	27.1	24	21.5	-	-	
PT 80-360/110		80x80	11	15	36	-	-	-	-	-	-	-	-	34.5	33	31.5	30.8	28	25.5	-	-	
PT 80-420/150		80x80	15	20	42	-	-	-	-	-	-	-	-	41	40	38.5	37.8	35	33	29.5	-	
PT 100-270/110		100x100	11	15	27	-	-	-	-	-	-	-	-	-	-	-	27.3	26	24.5	22.5	16	
PT 100-320/150		100x100	15	20	32.8	-	-	-	-	-	-	-	-	-	-	-	32.5	31.3	30.2	28.5	22.1	
PT 100-390/185		100x100	18.5	25	39	-	-	-	-	-	-	-	-	-	-	-	38	36.8	36.7	33.8	28.8	
PT 100-480/220		100x100	22	30	48	-	-	-	-	-	-	-	-	-	-	-	47.5	45.5	43.5	41	32.5	
PT 100-600/300		100x100	30	40	60	-	-	-	-	-	-	-	-	-	-	-	59.5	58	57	54.5	47	

★ = Stainless steel impeller/Impulsor en inox/Roue en acier inoxydable

## PERFORMANCE CURVE/CURVA DE RENDIMIENTO/COURBE DE PERFORMANCE

60Hz n = 3500 r/min

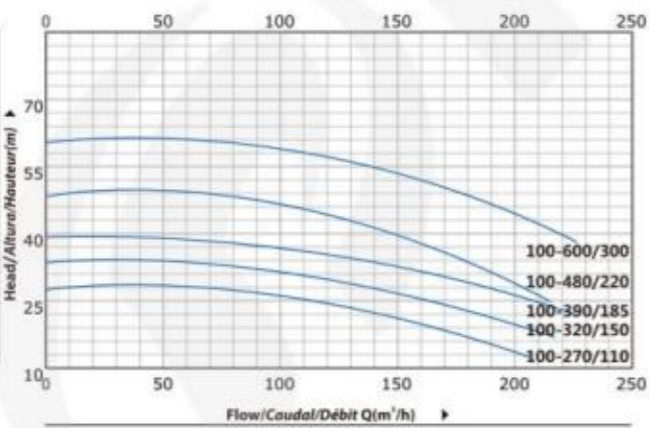
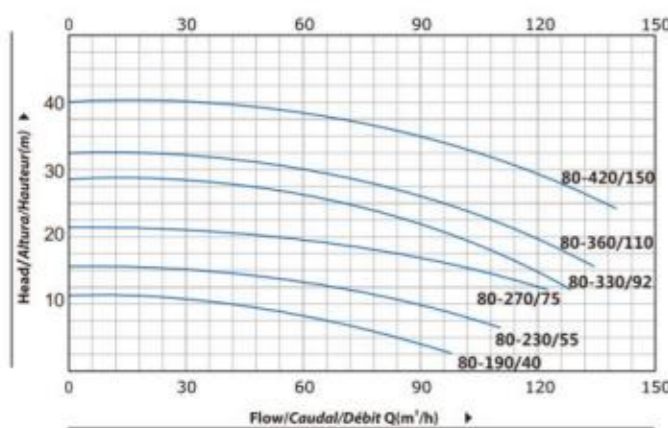
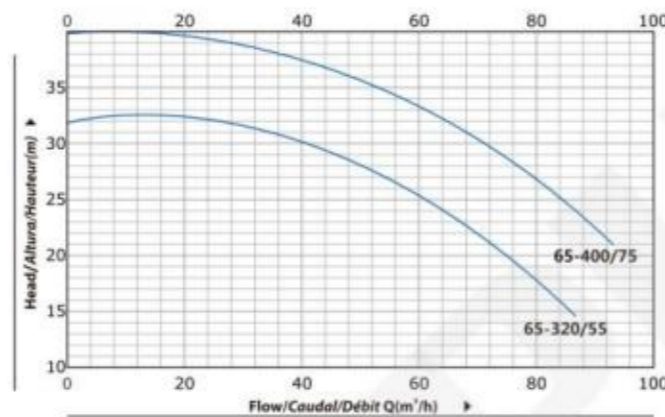
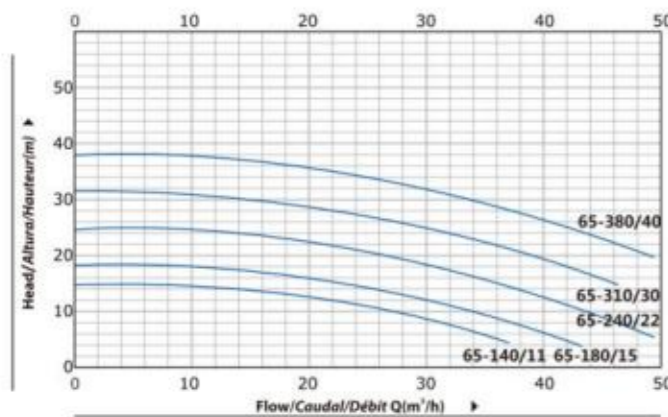
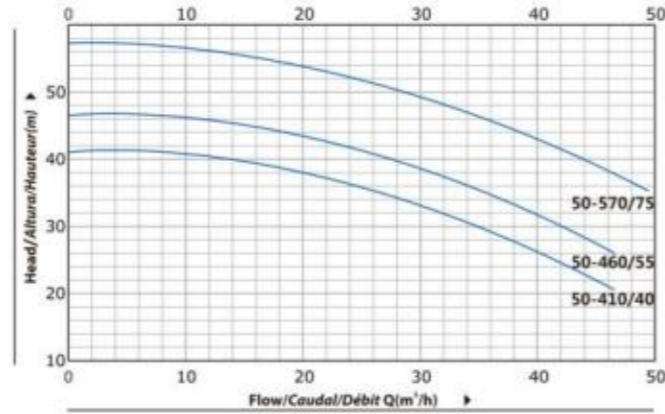
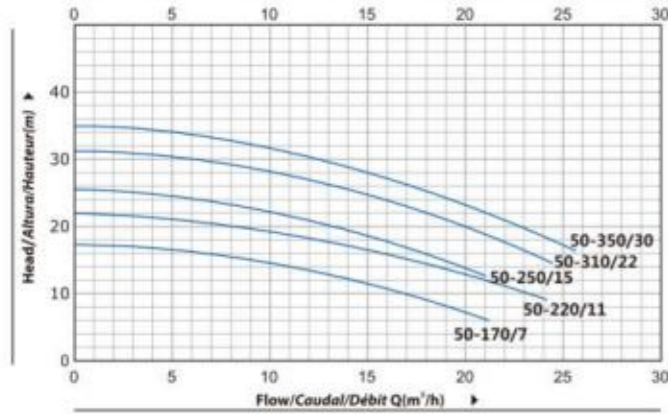

## MATERIAL DESCRIPTION/DESCRIPCIÓN DE MATERIAL/DESCRIPTION DU MATÉRIEL

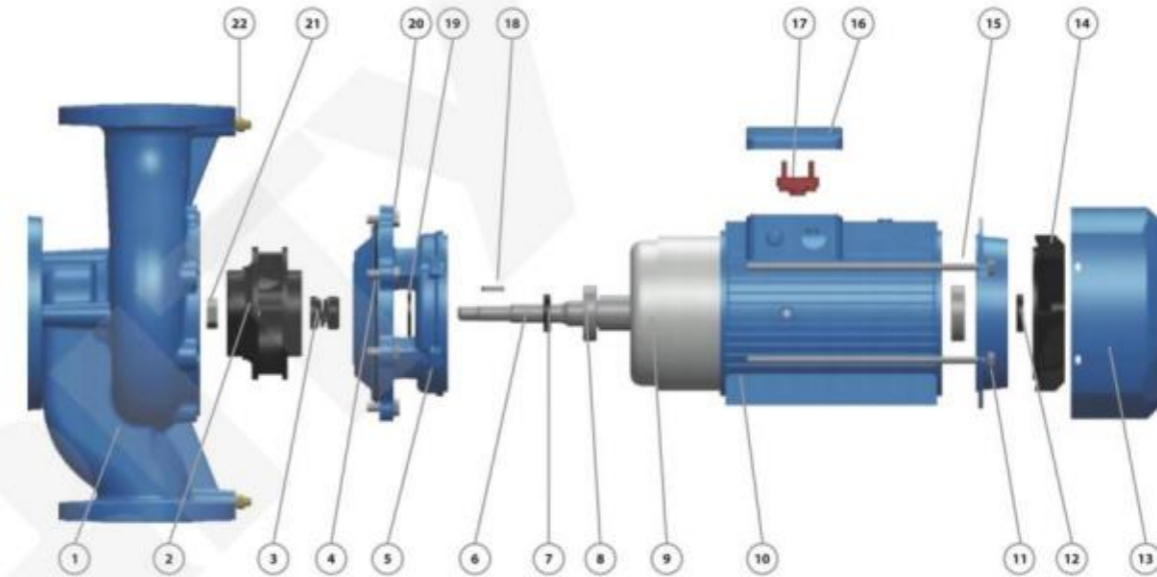

No.	Description Descripción Description	Material Material Matériel	No.	Description Descripción Description	Material Material Matériel	No.	Description Descripción Description	Material Material Matériel
1	Pump Case Cuerpo de Bomba Boîtier de pompe	Cast iron Fundición Fonte	9	Wound Stator/Rotor Estator/Rotor Stator/Rotor	Silicon Steel/Copper Silicio/Cobre Silicium/Cuivre	17	Terminal Board Tablero Bornas Bornier	Plastic Plástico Plastique
2	Impeller Impulsor Roue	SS304/Cast iron Inox 304/Fundición Inox 304/Fonte	10	Motor Case Cuerpo Motor Boîtier Moteur	Aluminum Aluminio Aluminium	18	Impeller Key Chaveta Clé	Iron Hierro Le fer
3	Mechanical Seal Cierre Mecánico Sceller	SiC/Carbon/SS304 SiC/Grafito/Inox304 SiC/Carbon/Inox304	11	Back Cover Tapa Trasera Capot Arrière	Cast iron Fundición Fonte	19	Water Deflector Deflector Déflecteur	Rubber Caucho Caoutchouc
4	O-ring Junta Tórica Joint Torique	Rubber Caucho Caoutchouc	12	Reinforced Seal Sello Reforzado Sceller	Rubber Caucho Caoutchouc	20	Connection Bolt Perno Boulon de connexion	Steel Acero Acier
5	Connection Conexión Lien	Cast iron Fundición Fonte	13	Fan Cover Tapa Capot	Aluminum Aluminio Aluminium	21	Impeller Nut Nuez Noix	Galvanized Steel Acero Galvanizado Acier Galvanisé
6	Shaft Eje Arbre	SS304-45# Steel Inox 304-Hierro Inox304-Acier	14	Fan Ventilador Ventilateur	Plastic Plástico Plastique	22	Release Valve Tapón Cebado Soupape de décharge	Brass Bronce Laiton
7	Reinforced Seal Sello Reforzado Sceller	Rubber Caucho Caoutchouc	15	Through Bolt Perno Boulon	Steel Acero Acier			
8	Bearing Rodamiento Palier	Ball Bearing Bola Rodamiento Palier Balle	16	Terminal Box Caja Bornas Boîte Bornes	Aluminum Aluminio Aluminium			

## DIMENSIONS AND WEIGHT/DIMENSIONES Y PESOS/DIMENSIONS ET POIDS

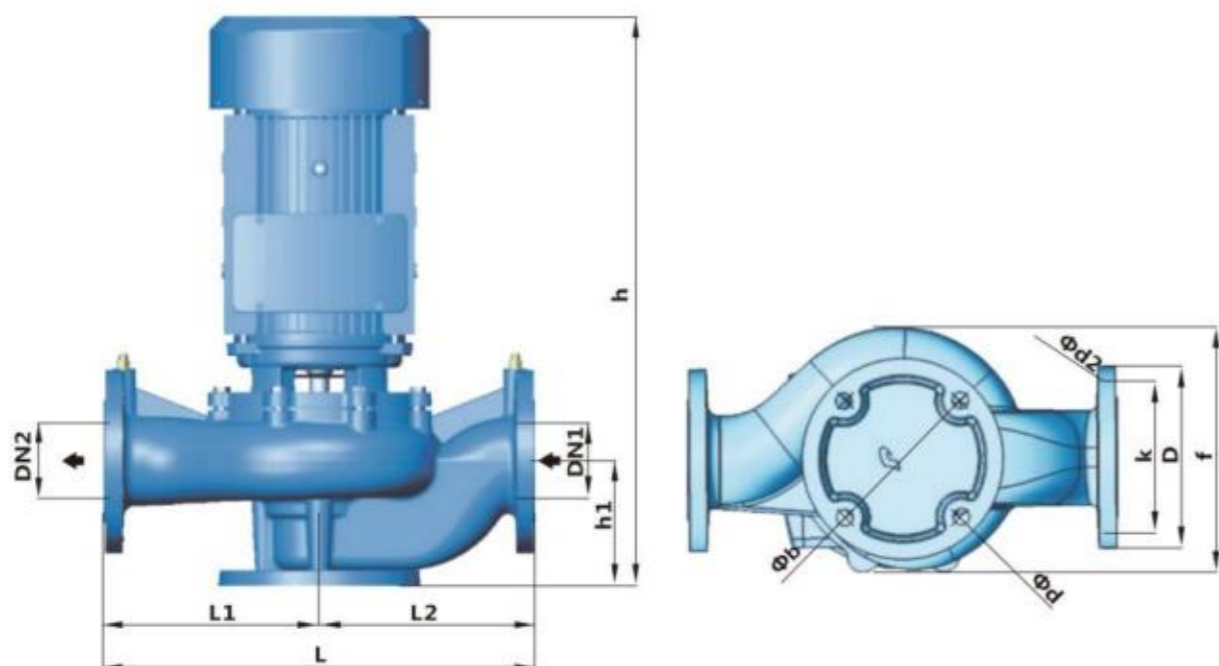

MODEL MODELO MODÈLE	DIMENSIONS/DIMENSIONES/DIMENSIONS mm													kg	
	DN1	DN2	h	h1	L	b	f	d	L1	L2	D	K	d2	1~	3~
50-170/7	50	50	475	115	340	145	197	18	170	170	165	125	4*18	26	24
50-220/11	50	50	475	115	340	145	197	18	170	170	165	125	4*18	27	25
50-250/15	50	50	450	100	322	145	229	18	161	161	165	125	4*18	36	34
50-310/22	50	50	450	100	322	145	229	18	161	161	165	125	4*18	41	39
50-350/30	50	50	480	100	322	145	229	18	161	161	165	125	4*18	52	50
50-410/40	50	50	485	115	440	160	277	18	220	220	165	125	4*18	-	59
50-460/55	50	50	485	115	440	160	277	18	220	220	165	125	4*18	-	66
50-570/75	50	50	485	115	440	160	277	18	220	220	165	125	4*18	-	73
65-140/11	65	65	465	105	360	145	212	18	180	180	185	145	4*18	29	27
65-180/15	65	65	465	105	360	145	212	18	180	180	185	145	4*18	31	29
65-240/22	65	65	465	105	360	145	212	18	180	180	185	145	4*18	36	34
65-310/30	65	65	530	112	400	160	250	18	200	200	185	145	4*18	50	48
65-380/40	65	65	530	112	400	160	250	18	200	200	185	145	4*18	-	50
65-320/55	65	65	583	112	400	160	263	18	200	200	185	145	4*18	-	64
65-400/75	65	65	583	112	400	160	263	18	200	200	185	145	4*18	-	71
80-190/40	80	80	615	135	470	180	267	18	235	235	200	160	8*18	-	56
80-230/55	80	80	615	135	470	180	267	18	235	235	200	160	8*18	-	68
80-270/75	80	80	615	135	470	180	267	18	235	235	200	160	8*18	-	74
80-330/92	80	80	658	135	470	200	290	18	235	235	200	160	8*18	-	90
80-360/110	80	80	658	135	470	200	290	18	235	235	200	160	8*18	-	106
80-420/150	80	80	780	135	470	200	290	18	235	235	200	160	8*18	-	134
100-270/110	100	100	685	160	552	220	310	18	276	276	220	180	8*18	-	113
100-320/150	100	100	807	160	552	220	310	18	276	276	220	180	8*18	-	143
100-390/185	100	100	807	160	552	220	310	18	276	276	220	180	8*18	-	150
100-480/220	100	100	880	160	552	220	322	18	276	276	220	180	8*18	-	212
100-600/300	100	100	950	160	552	220	322	18	276	276	220	180	8*18	-	222

**PGW**

Single suction centrifugal pump

**PG**

Single suction centrifugal pump  
 Bomba centrífuga de succión simple  
 Pompe centrifuge à aspiration unique



PGL



PGW



PGLH



PGWH



PGWB



PGL-G



PGW-G



PGLB

**NEW/NUEVO/NOUVEAU**  
 DESCRIPTION/DESCRIPCIONES/ DESCRIPTION

- Complete range with a full series of centrifugal pump
  - Vertical and horizontal design suitable for any installation
  - Stainless steel 304 casting material available for all models
  - Available equipped with explosion-proof motors
  - The big range pumps compatible with many applications
  - Pump case with anti-corrosive coating
  - Quality bearing, wear resistance mechanical seal
- Gama completa con una serie completa de bombas
  - Diseño vertical y horizontal adecuado para cualquier instalación
  - Material de fundición de inox304 disponible para todos los modelos
  - Disponible con motores a prueba de explosión
  - La impresionante gama compatibles con muchas aplicaciones
  - Caja de bomba con revestimiento anticorrosivo
  - Rodamiento de calidad, sello mecánico personalizado
- Gamme complète avec une série complète de pompes
  - Conception verticale et horizontale adaptée à toute installation
  - Matériau de coulée en inox304 disponible pour tous les modèles
  - Disponible équipé de moteurs antidéflagrants
  - La gamme impressionnante compatibles avec de nombreuses applications
  - Boîtier de pompe avec revêtement anti-corrosif
  - Roulement de qualité, joint mécanique résistant à l'usure

**MODEL CODE/CÓDIGO MODELO/CODE MODÈLE**

For example/Par ejemplo/Par exemple

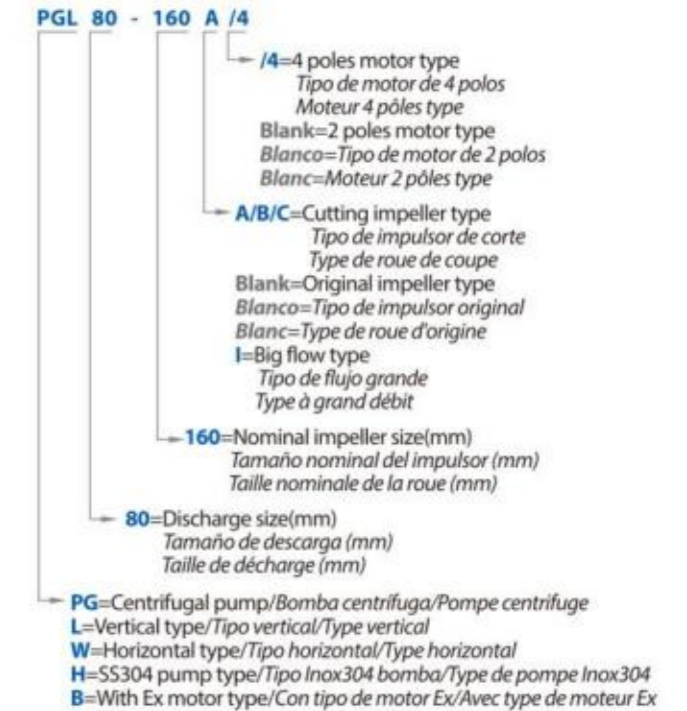

## TECHNICAL DATA/DATOS TÉCNICOS/DONNÉES TECHNIQUES

60Hz n=3500 r/min

MODEL MODELO MODÈLE	Power Potencia Puissance		Flow Caudal Débit	Head Altura Hauteur	DN	Wt	Dim
	kw	hp					
25-125	0.75	1	4	20	25x25	28	26x23x43
25-160	1.5	2	4	32	25x25	39	30x27x43
25-160A	1.1	1.5	3.7	28	25x25	34	30x27x43
32-125	0.75	1	5	20	32x32	28	26x23x44
32-160	1.5	2	4.5	32	32x32	39	32x27x50
32-160A	1.1	1.5	4	28	32x32	38	32x27x41
32-200	3	4	4.5	50	32x32	55	34x33x54
32-200A	2.2	3	4	44	32x32	74	34x33x54
40-100	0.75	1	6.3	12.5	40x40	32	26x23x44
40-125	1.1	1.5	6.3	20	40x40	34	26x23x44
40-125A	0.75	1	5.6	16	40x40	3	28x23x44
40-160	2.2	3	6.3	32	40x40	47	32x27x50
40-160A	1.5	2	5.9	28	40x40	43	32x27x50
40-160B	1.1	1.5	5.5	24	40x40	38	32x27x50
40-200	4	5.5	6.3	50	40x40	74	34x33x56
40-200A	3	4	5.9	44	40x40	62	34x33x56
40-200B	2.2	3	5.3	38	40x40	52	34x33x56
40-250	7.5	10	6.3	80	40x40	105	40x40x63
40-250A	5.5	7.5	5.9	70	40x40	98	40x40x63
40-250B	4	5.5	5.5	60	40x40	77	40x40x63
40-100(I)	1.1	1.5	12.5	12.5	40x40	34	30x23x45
40-100(I)A	0.75	1	11	10	40x40	32	30x23x45
40-125(I)	1.5	2	12.5	20	40x40	38	30x24x46
40-125(I)A	1.1	1.5	11	16	40x40	33	30x24x45
40-160(I)	3	4	12.5	32	40x40	56	34x30x55
40-160(I)A	2.2	3	11.7	28	40x40	47	34x30x51
40-160(I)B	1.5	2	10.4	22	40x40	36	34x30x48
40-200(I)	5.5	7.5	12.5	50	40x40	85	36x35x63
40-200(I)A	4	5.5	11.7	44	40x40	75	36x35x57
40-200(I)B	3	4	10.6	36	40x40	63	36x35x55
40-250(I)	11	15	12.5	80	40x40	145	45x43x78
40-250(I)A	7.5	10	11.6	70	40x40	95	45x36x65
40-250(I)B	7.5	7.5	10	60	40x40	94	45x36x65
50-100(1)	1.1	1.5	12.5	12.5	50x50	36	29x23x45
50-100(1)A	0.75	4	11	10	50x50	35	29x23x45
50-125	1.5	2	12.5	20	50x50	43	30x24x46
50-125A	1.1	1.5	11	16	50x50	38	30x24x45
50-160	3	4	12.5	32	50x50	59	32x30x55
50-160A	2.2	3	11.7	28	50x50	51	32x30x51
50-160B	1.5	2	10.4	22	50x50	47	32x40x49
50-200	5.5	7.5	12.5	50	50x50	101	36x35x63
50-200A	4	5.5	11.7	44	50x50	800	36x35x57
50-200B	3	4	10.6	36	50x50	68	36x35x55
50-250	11	15	12.5	80	50x50	160	44x43x78
50-250A	7.5	10	11.6	70	50x50	115	44x43x65
50-250B	5.5	7.5	10.8	60	50x50	114	44x36x65
50-100(1)	1.5	2	25	12.5	50x50	41	32x23x48
50-100(1)A	1.1	1.5	22.3	10	50x50	36	32x23x46
50-125(1)	3	4	25	20	50x50	56	34x28x55
50-125(1)A	2.2	3	22.3	16	50x50	48	34x28x52
50-160(1)	4	5.5	25	32	50x50	72	36x30x57

MODEL MODELO MODÈLE	Power Potencia Puissance		Flow Caudal Débit	Head Altura Hauteur	DN	Wt	Dim
	kw	hp					
50-160(I)A	3	4	23.4	28	50x50	71	36x30x57
50-200(I)	7.5	10	25	50	50x50	108	38x35x64
50-200(I)A	5.5	7.5	23.5	44	50x50	107	38x35x64
50-250(I)	15	20	25	80	50x50	175	46x44x79
50-250(I)A	11	15	23.4	70	50x50	165	46x44x79
50-315(I)	30	40	25	125	50x50	310	55x51x92
50-315(I)A	22	30	23.7	113	50x50	245	55x47x86
50-315(I)B	18.5	25	22.5	101	50x50	215	55x44x83
50-315(1)C	15	20	20.6	85	50x50	199	55x41x78
65-100	1.5	2	25	12.5	65x65	46	32x23x47
65-100A	1.1	1.5	22.3	10	65x65	41	32x23x46
65-125	3	4	25	20	65x65	58	34x28x55
65-125A	2.2	3	22.3	16	65x65	49	34x28x52
65-160	4	5.5	25	32	65x65	75	36x31x57
65-160A	3	4	23.4	28	65x65	75	36x31x57
65-200	7.5	10	21.8	38	65x65	107	38x35x63
65-200A	5.5	7.5	21.8	38	65x65	107	38x35x63
65-250	15	20	25	80	65x65	180	48x44x79
65-250A	11	15	23.4	70	65x65	170	48x44x79
65-315	30	40	25	125	65x65	320	55x51x92
65-315A	22	30	23.7	113	65x65	255	55x47x86
65-315B	18.5	25	22.5	101	65x65	225	55x44x83
65-315C	15	20	20.6	85	65x65	207	55x41x78
65-100(I)	3	4	50	12.5	65x65	63	40x28x57
65-100(I)A	2.2	3	44.7	10	65x65	53	40x24x54
65-125(I)	5.5	7.5	50	20	65x65	99	40x36x66
65-125(I)A	4	5.5	45	16	65x65	78	40x32x60
65-160(I)	7.5	10	50	32	65x65	103	40x36x66
65-160(I)A	5.5	7.5	43	38	65x65	103	40x36x66
65-200(I)	15	20	50	50	65x65	176	45x43x80
65-200(I)A	11	15	47	44	65x65	166	45x43x80
65-200(I)B	7.5	10	43.3	38	65x65	114	45x43x67
65-250(I)	22	30	50	80	65x65	235	48x47x87
65-250(I)A	18.5	25	46.7	70	65x65	205	48x43x85
65-250(I)B	15	20	43.3	60	65x65	180	48x43x81
65-315(I)	37	50	50	125	65x65	350	58x53x100
65-315(I)A	30	40	46.5	110	65x65	335	58x53x100
65-315(I)B	22	30	41	85	65x65	309	58x50x87
80-100	3	4	50	12.5	80x80	63	40x28x57
80-100A	2.2	30	44.7	10	80x80	54	40x24x54
80-125	5.5	7.5	50	20	80x80	99	40x36x66
80-125A	4	5.5	45	16	80x80	79	40x32x60
80-125B	3	4	40	15	80x80	58	40x29x59
80-160	7.5	10	50	32	80x80	105	40x36x66
80-160A	5.5	7.5	43.4	24	80x80	98	40x36x66
80-200	15	20	50	50	80x80	175	43x43x80
80-200A	11	15	47	44	80x80	165	43x43x80
80-200B	7.5	10	43.3	38	80x80	115	43x36x66
80-250	22	30	50	80	80x80	240	48x47x87
80-250A	18.5	25	46.7	70	80x80	210	48x43x85
80-250B	15	20	43.3	60	80x80	185	48x43x81

## TECHNICAL DATA/DATOS TÉCNICOS/DONNÉES TECHNIQUES

60Hz n=3500 r/min

MODEL MODELO MODÈLE	Power Potencia Puissance		Flow Caudal Débit	Head Altura Hauteur	DN	Wt	Dim
	kw	hp					
80-315	37	50	50	125	80x80	355	58x53x100
80-315A	30	40	46.5	110	80x80	340	58x53x100
80-315B	30	40	44.5	100	80x80	340	58x53x100
80-315C	22	30	41	85	80x80	275	58x47x89
80-350	55	75	50	150	80x80	535	64x64x117
80-350A	45	60	44.5	142	80x80	420	64x58x108
80-350B	37	50	41	135	80x80	366	64x52x104
80-100(I)	5.5	7.5	100	12.5	80x80	108	46x36x68
80-100(I)A	4	5.5	89	10	80x80	87	46x36x62
80-125(I)	11	15	100	20	80x80	163	45x43x81
80-125(I)A	7.5	10	89	16	80x80	113	45x35x67
80-160(I)	15	20	100	32	80x80	184	50x43x84
80-160(I)A	11	15	93.5	28	80x80	174	50x43x84
80-200(I)	22	30	100	50	80x80	251	48x48x88
80-200(I)A	18.5	25	93.5	44	80x80	220	48x43x86
80-200(I)B	15	20	87	38	80x80	198	48x43x81
80-250(I)	37	50	100	80	80x80	330	55x52x102
80-250(I)A	30	40	93.5	70	80x80	315	55x52x102
80-315(I)	75	100	100	125	80x80	675	64x70x124
80-315(I)A	55	75	95	113	80x80	535	64x64x117
80-315(I)B	45	60	90	101	80x80	420	64x58x108
80-315(I)C	37	50	82	85	80x80	366	64x52x104
100-100	5.5	7.5	100	12.5	100x100	113	46x36x67
100-100A	4	5.5	89	10	100x100	91	46x32x62
100-125	11	15	100	20	100x100	169	44x43x81
100-125A	7.5	10	89	16	100x100	118	45x35x67
100-160	15	20	100	32	100x100	191	50x43x84
100-160A	11	15	93.5	28	100x100	181	50x43x84
100-200	22	30	100	50	100x100	245	48x48x88
100-200A	18.5	25	93.5	44	100x100	215	48x43x86
100-200B	15	20	87	38	100x100	193	48x43x82
100-250	37	50	100	80	100x100	345	55x52x102
100-250A	30	40	93.5	70	100x100	330	55x52x102
100-315	75	100	100	125	100x100	689	64x70x124
100-315A	55	75	95	113	100x100	549	64x64x117
100-315B	45	60	90	101	100x100	439	64x58x108
100-315C	37	50	82	85	100x100	435	64x54x99
100-350	90	120	100	150	100x100	950	68x63x131
100-350A	75	100	88	142	100x100	830	68x63x126
100-350B	55	75	80	135	100x100	600	68x61x119
100-100(I)	11	15	160	12.5	100x100	115	50x42x80
100-125(I)	15	20	160	20	100x100	168	50x30x81
100-125(I)A	11	15	140	17	100x100	168	50x28x81
100-160(I)	22	30	160	32	100x100	210	50x33x89
100-160(I)A	18.5	25	140	28	100x		



## TECHNICAL DATA/DATOS TÉCNICOS/DONNÉES TECHNIQUES

MODEL MODELO MODÈLE	Power Potencia Puissance		Flow Caudal Débit	Head Altura Hauteur	DN	Wt	Dim
	kw	hp					
150-350	110	150	160	150	150x150	980	76x90x156
150-350A	90	120	150	142	150x150	800	76x70x133
150-350B	75	100	140	135	150x150	724	76x70x121
150-200(I)	75	100	400	40	150x150	712	66x70x122
150-200(I)A	55	75	360	35	150x150	687	66x70x119
150-250(I)	75	100	200	80	150x150	702	70x70x128
150-250(I)A	55	75	187	70	150x150	561	70x64x120
200-200	75	100	400	40	200x200	198	66x70x122
200-200A	55	75	360	35	200x200	167	66x70x119
200-250	132	176	400	80	200x200	281	75x90x157
200-250A	110	150	352	70	200x200	257	75x90x146
200-250B	90	120	320	56	200x200	243	75x70x127
200-315	132	176	300	110	200x200	354	80x90x157
200-315A	110	150	300	88	200x200	293	80x90x146
200-315B	90	100	290	80	200x200	277	80x90x127

## TECHNICAL DATA/DATOS TÉCNICOS/DONNÉES TECHNIQUES

60Hz n=1750 r/min

MODEL MODELO MODÈLE	Power Potencia Puissance		Flow Caudal Débit	Head Altura Hauteur	DN	Wt	Dim
	kw	hp					
50-315(I)/4	4	5.5	12.5	32	50x50	89	55x51x92
50-315(I)A/4	3	4	11.7	28	50x50	84	55x47x86
65-315/4	4	5.5	12.5	32	65x65	89	55x51x92
65-315A/4	3	4	11.7	28	65x65	85	55x47x86
65-315B/4	3	4	10	21	65x65	82	55x44x84
65-250(I)/4	3	4	25	20	65x65	85	48x47x87
65-250(I)A/4	3	4	22.2	15.8	65x65	80	48x43x85
65-315(I)/4	5.5	7.5	25	32	65x65	120	58x53x100
65-315(I)A/4	4	5.5	22.5	26	65x65	110	58x53x100
65-315(I)B/4	4	5.5	20	21	65x65	100	58x53x100
80-250/4	3	4	25	20	80x80	89	48x47x87
80-250A/4	3	4	22.2	15.8	80x80	85	48x43x85
80-315/4	5.5	7.5	25	32	80x80	130	58x53x100
80-315A/4	4	5.5	23	27.9	80x80	102	58x53x100
80-200(I)/4	3	4	50	12.5	80x80	97	48x48x88
80-250(I)/4	5.5	7.5	50	20	80x80	134	55x52x102
80-250(I)A/4	4	5.5	46	17	80x80	106	55x52x102
80-250(I)B/4	3	4	40.5	13	80x80	100	55x52x102
80-315(I)/4	11	15	50	32	80x80	217	64x70x124
80-315(I)A/4	7.5	10	46	27.9	80x80	180	64x65x117
80-315(I)B/4	5.5	7.5	40.5	21	80x80	166	64x58x108
100-200/4	3	4	50	12.5	100x100	100	48x48x88
100-250/4	5.5	7.5	50	20	100x100	140	55x52x102
100-250A/4	4	5.5	46	17	100x100	112	55x52x102
100-250B/4	3	4	40.5	13	100x100	105	55x52x102
100-315/4	11	15	50	32	100x100	225	64x70x124
100-315A/4	7.5	10	46.7	27.9	100x100	180	64x64x117
100-315B/4	5.5	7.5	40.5	21	100x100	165	64x58x108
100-160(I)/4	4	5.5	80	8	100x100	118	50x33x89
100-160(I)A/4	3	4	72	6	100x100	113	50x33x89
100-200(I)/4	5.5	7.5	80	12.5	100x100	148	54x36x97
100-200(I)A/4	4	5.5	72	10	100x100	123	54x35x97
100-250(I)/4	11	15	100	20	100x100	208	60x44x112
100-250(I)A/4	7.5	10	93.3	17.4	100x100	165	60x36x112
100-250(I)B/4	5.5	7.5	69	15	100x100	149	60x36x112
100-315(I)/4	15	20	80	32	100x100	234	63x45x129
100-315(I)A/4	11	15	75	27.5	100x100	213	63x45x129
100-315(I)B/4	7.5	10	72	24	100x100	165	63x45x129
100-400(I)/4	30	40	80	44	100x100	375	71x54x129
100-400(I)A/4	22	30	75	44	100x100	295	71x54x129
100-400(I)B/4	18.5	25	70	38	100x100	257	71x54x129
125-160/4	3	4	80	8	125x125	205	52x46x92
125-200/4	5.5	7.5	80	12.5	125x125	249	54x51x104
125-200A/4	4	5.5	75	11	125x125	237	54x51x104
125-250/4	11	15	100	20	125x125	220	68x66x118
125-250A/4	7.5	10	93.3	17.4	125x125	210	68x57x108
125-250B/4	5.5	7.5	87	15	125x125	195	68x51x105
125-315/4	15	20	100	32	125x125	300	68x69x135
125-315A/4	11	15	95	27	125x125	282	68x69x135
125-315B/4	11	15	87	24	125x125	245	68x69x135
125-400/4	30	40	100	50	125x125	375	71x54x105

MODEL MODELO MODÈLE	Power Potencia Puissance		Flow Caudal Débit	Head Altura Hauteur	DN	Wt	Dim
	kw	hp					
125-400A/4	22	30	94	44	125x125	295	71x54x105
125-400B/4	18.5	25	87	37.5	125x125	257	71x54x100
125-200(I)/4	11	15	200	12.5	125x125	244	68x44x64
125-200(I)A/4	7.5	10	179	10	125x125	210	68x42x62
125-250(I)/4	15	20	200	20	125x125	265	68x42x91
125-250(I)A/4	11	15	184.4	17	125x125	241	68x42x91
125-250(I)B/4	7.5	10	167	14	125x125	210	68x42x85
125-315(I)/4	22	30	200	32	125x125	335	74x47x98
125-315(I)A/4	18.5	25	187	28	125x125	315	74x44x95
125-315(I)B/4	15	20	173	24	125x125	265	74x44x95
150-200/4	11	20	150	12.5	150x150	265	68x44x93
150-200A/4	18.5	15	120	10	150x150	244	68x44x89
150-250/4	15	25	150	20	150x150	300	70x48x96
150-250A/4	11	20	130	17	150x150	262	70x48x94
150-250B/4	7.5	15	100	14	150x150	241	70x45x90
150-315/4	30	40	200	32	150x150	410	76x53x108
150-315A/4	22	30	187	28	150x150	335	76x51x100
150-315B/4	18.5	25	173	24	150x150	315	76x51x96
150-400/4	45	60	200	50	150x150	490	80x60x112
150-400A/4	37	50	187	44	150x150	454	80x60x110
150-400B/4	30	40	174	38	150x150	435	80x56x108
150-400C/4	22	30	160	32	150x150	365	80x54x100
150-500/4	90	120	200	80	150x150	523	90x68x130
150-500A/4	75	100	182	70.5	150x150	478	90x68x125
150-500B/4	55	75	166	62	150x150	461	90x68x122
150-200(I)/4	11	20	200	12.5	150x150	265	68x44x93
150-200(I)A/4	7.5	15	179	10	150x150	244	68x44x89
150-250(I)/4	18.5	25	200	20	150x150	305	75x48x96
150-250(I)A/4	15	20	187	17.5	150x150	267	75x48x94
150-250(I)B/4	11	15	173	14	150x150	246	75x45x90
200-200/4	11	20	200	12.5	200x200	265	68x44x93
200-200A/4	7.5	15	179	10	200x200	244	68x44x89
200-250/4	18.5	25	200	20	200x200	305	75x48x96
200-250A/4	15	20	184.4	17	200x200	267	75x48x94
200-250B/4	11	15	179	14	200x200	246	75x45x90
200-315/4	30	40	200	32	200x200	417	80x53x108
200-315A/4	22	30	187	28	200x200	342	80x51x100
200-315B/4	18.5	25	173	24	200x200	322	80x51x96
200-400/4	45	60	200	50	200x200	498	86x60x112
200-400A/4	37	50	187	44	200x200	462	86x60x110
200-400B/4	30	40	174	38	200x200	443	86x56x108
200-400C/4	22	30	160	32	200x200	373	86x54x100
200-500/4	90	120	200	80	200x200	843	108x68x135
200-500A/4	75	30	182	70.5	200x200	783	108x68x130
200-500B/4	55	30	166	62	200x200	680	108x68x126
200-200(I)/4	22	30	400	12.5	200x200	382	81x53x103
200-200(I)A/4	18.5	25	358	10	200x200	346	81x53x97
200-250(I)/4	30	40	400	20	200x200	475	83x53x111
200-250(I)A/4	22	30	358	16	200x200	405	83x51x104
200-250(I)B/4	18.5	25	322	13	200x200	387	83x51x100
200-250(I)C/4	15	75	262	13	200x200	273	83x48x97



**PSC**

**Double suction split case pump**  
**Succión doble bomba de cámara partida**  
**Pompe à double corps d'aspiration**



**NEW/NUEVO/NOUVEAU**  
**DESCRIPTION/DESCRIPCIONES/DESCRIPTION**

- ♦ Axially split volute pump casing design
- ♦ Pump case with anti-corrosive coating HT250
- ♦ Double-entry radial impeller in AISI 304 or HT250
- ♦ Shaft protecting sleeves in the seal area
- ♦ Mechanical seal and gland packing are both available
- ♦ Grease-packed rolling element bearings sealed for life
- ♦ Reliable complete with motor or diesel for fire fighting etc.

- ♦ Diseño de carcasa de bomba de voluta dividida axialmente
- ♦ Caja de bomba con recubrimiento anticorrosivo HT250
- ♦ Impulsor radial de doble entrada en inox304 o HT250
- ♦ Mangas de protección del eje en el área del sello
- ♦ El sello mecánico y el empaque de la glándula están disponibles
- ♦ Rodamientos de elementos rodantes rellenos de grasa
- ♦ Completamente confiable con motor o diesel para incendios etc.

- ♦ Conception de corps de pompe à volute divisée axialement
- ♦ Carter de pompe avec revêtement anti-corrosif HT250
- ♦ Roue radiale à double entrée en inox304 ou HT250
- ♦ Manchons de protection d'arbre dans la zone d'étanchéité
- ♦ Le joint mécanique et le presse-étoupe sont disponibles
- ♦ Roulements d'éléments roulants graissés scellés à vie
- ♦ Fiable complet avec moteur ou diesel pour la lutte l'incendie etc.

**USING LIMITS/LÍMITES UTILIZACIÓN/UTILISATION LIMITES**

- ♦ Liquid temperature between -10°C and +120°C
- ♦ Ambient temperature between 0°C and +50°C
- ♦ Max. working pressure **25 bar**/Continuous S1
- ♦ Temperatura del líquido de -10 °C hasta +120 °C
- ♦ Temperatura ambiente de 0 °C hasta +50 °C
- ♦ Presión máxima **25 bar**/Continuo S1
- ♦ Température du liquide entre -10 °C et +120 °C
- ♦ Température ambiante entre 0 °C et +50 °C
- ♦ Max. pression de service **25 bar**/Continu S1

**MODEL CODE/CÓDIGO MODELO/CODE MODÈLE**

For example/Por ejemplo/Par exemple

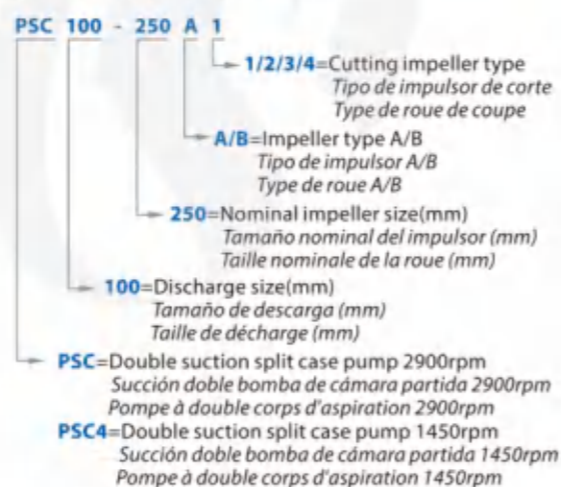

**TECHNICAL DATA/DATOS TÉCNICOS/DONNÉES TECHNIQUES**

**PSC4 50/60Hz n=1450/1750 r/min**

MODEL MODELO MODÈLE	Flow Range Rango de Caudal Gamme de débit m³/h	Head Range Rango de Altura Gamme de tête m	Power Range Rango de Potencia Gamme de puissance kw	DN mm
80-210A1	131-164-197	60.5-55-50	26.8-29.9-33.4	125x80
80-210A2	121-151-181	52-47.5-42.2	21.6-24.1-26.1	125x80
80-210A3	115-144-173	44-39-35	17.8-19-21.1	125x80
80-210A4	110-137-164	37-33.5-27.7	14.7-16-16.7	125x80
80-210B1	107-134-160	55.5-51-46	20.5-22.9-25.1	125x80
80-210B2	106-133-159	47.7-43.5-37	17.6-19.3-20	125x80
80-210B3	100-124-149	40-36-30	14.4-15.6-16.5	125x80
80-210B4	91-113-136	35-31-27	12.1-12.9-13.9	125x80
80-270A1	166-207-248	97.5-90-79	57-64.6-70.8	125x80
80-270A2	156-194-233	83.5-77-69	46.6-52.6-58.1	125x80
80-270A3	147-184-220	70-63.5-55	37.5-41.8-44.6	125x80
80-270A4	138-173-198	56.5-50-45	28.7-31.4-32.8	125x80
80-270B1	137-171-205	91-82.5-72.5	44.6-49.9-54.1	125x80
80-270B2	122-153-184	79.5-71.5-67	35.6-39.1-44.7	125x80
80-270B3	115-144-173	66.8-60-53	28.5-31.3-33.7	125x80
80-270B4	110-137-164	54.5-49-42	22.4-24.5-25.9	125x80
100-250A1	230-288-346	83-75-67	64.2-70.9-78.4	150x100
100-250A2	219-274-328	69-63-55	51.9-58.3-62.3	150x100
100-250A3	209-261-313	59-52-46.5	43.5-46.8-51.5	150x100
100-250A4	193-240-290	49-45-37	33.9-37.7-39.2	150x100
100-250B1	196-245-294	75-68-59	50-55.6-59.8	150x100
100-250B2	180-223-268	65-59-51	40.6-44.7-47.9	150x100
100-250B3	165-205-246	56-51-44	32.9-36.8-38.8	150x100
100-250B4	150-190-227	48-43-38	26.4-29.1-31.1	150x100
100-310A1	294-367-440	135-123-105	137.7-153.8-164	150x100
100-310A2	268-335-402	116-106-92	108-121.4-131	150x100
100-310A3	242-302-363	98-90-80	82.7-93.5-102.5	150x100
100-310A4	182-227-333	86-81-63	62-68-76	150x100
100-310B1	226-283-340	130-119-105	105-117.4-128.5	150x100
100-310B2	208-260-310	111-103-90	81.8-93.7-100	150x100
100-310B3	200-250-300	92-84-74	65.8-72.8-80.5	150x100
100-310B4	187-234-281	78-69-60	53.1-57.1-61.2	150x100
125-230A1	426-541-639	68-60-48	93.8-101.8-101.9	200x125
125-230A2	392-490-585	60-52-43.5	78.1-82.1-84.4	200x125
125-230A3	363-454-544	50-43.5-35	63.4-65.1-66.6	200x125
125-230A4	340-425-489	40-34-30	49.4-50.8-52.5	200x125
125-230B1	377-472-566	68-60.5-51	84.2-92-101.5	200x125
125-230B2	349-436-523	60-53-44	70.3-74.8-77.2	200x125
125-230B3	328-410-493	52-45-37	60.1-61.3-63.3	200x125
125-230B4	305-382-458	42.5-37-30	47.1-49.9-49.9	200x125
125-290A1	428-535-642	117-108-95	166-187-202	200x125
125-290A2	397-497-596	97-88-75	131-145-153	200x125
125-290A3	363-454-544	80-72-62	101-111-117	200x125
125-290A4	323-403-484	65-57-47	74.7-80.2-80.5	200x125
125-290B1	383-480-575	113-100-85.5	145-157-166	200x125
125-290B2	348-436-523	93.5-83.5-70	112-121-126	200x125
125-290B3	308-385-462	78-70-60	84.5-93-96.9	200x125
125-290B4	274-342-410	60-55-47	59.6-67.4-70	200x125

MODEL MODELO MODÈLE	Flow Range Rango de Caudal Gamme de débit m³/h	Head Range Rango de Altura Gamme de tête m	Power Range Rango de Potencia Gamme de puissance kw	DN mm
80-210A1	66-83-100	15-13.8-12.2	3.4-3.8-4.2	125x80
80-210A2	61-76-90	13-11.8-10.5	2.7-3-3.3	125x80
80-210A3	58-72-87	11-9.8-8.7	2.2-2.4-2.6	125x80
80-210A4	55-69-83	9.1-8.2-7	1.8-2-2.1	125x80
80-210B1	52-65-78	14.2-12.8-10	2.6-2.8-3.1	125x80
80-210B2	52-64-77	12-10.8-11.7	2.1-2.4-3.1	125x80
80-210B3	50-61-73	10-9-7.8	1.8-1.9-2	125x80
80-210B4	47-58-70	8.7-7.6-6.5	1.5-1.6-1.8	125x80
80-270A1	83-104-125	24-22.5-19.5	7-8.1-8.8	125x80
80-270A2	80-99-120	21.3-19-17	6.1-6.6-7.4	125x80
80-270A3	72-90-108	17.5-16-13.7	4.6-5.2-5.4	125x80
80-270A4	67-84-100	13.8-13-11.5	3.4-4-4.3	125x80
80-270B1	68-85-102	23.1-20.7-18.2	5.7-6.2-6.7	125x80
80-270B2	61-77-92	20-18.1-16	4.5-5-5.3	125x80
80-270B3	58-72-86	16.5-15-13.2	3.5-3.9-4.2	125x80
80-270B4	53-67-80	13.8-12.5-10.8	2.7-3.1-3.2	125x80
80-370A1	90-113-136	42-38.8-33.5	14.8-16.2-17.3	125x80
80-370A2	80-99-120	35-33-29.1	10.6-12.1-13.3	125x80
80-370A3	70-88-106	29.3-27.5-24.7	8.2-9.4-10.2	125x80
80-370A4	65-81-98	23.8-22.5-20	6.4-7.4-8	125x80
80-370B1	80-99-120	38.8-35.5-31.3	11.8-13.1-14.3	125x80
80-370B2	72-90-108	34.1-30.8-26.3	9.7-10.8-11.4	125x80
80-370B3	60-76-90	27.5-25.5-22.5	7-8-8.5	125x80
80-370B4	53-67-80	21.3-20-17.5	4.9-5.7-6	125x80
100-250A1	115-144-173	21.2-18.8-17.5	8.2-8.9-10	150x100
100-250A2	112-140-167	17.5-15.8-13.2	6.7-7.4-7.7	150x100
100-250A3	100-126-150	14.5-13.5-11.9	5.1-5.9-6.3	150x100
100-250A4	97-120-145	12.2-11.2-9.5	4.2-4.7-5	150x100
100-250B1	98-122-147	18.8-17-15	6.2-7-7.6	150x100
100-250B2	90-112-135	16.3-14.5-12.7	5.1-5.6-6	150x100
100-250B3	85-106-128	13.7-12.5-11.3	4.1-4.7-5.3	150x100
100-250B4	75-94-113	12.1-11-9.6	3.3-3.7-3.9	150x100
100-310A1	148-185-222	34-31-26.8	17.4-19.6-21	150x100
100-310A2	133-166-200	29.3-27-24.3	13.4-15.3-17	150x100
100-310A3	120-151-180	24.8-22.5-20	10.5-11.7-12.8	150x100
100-310A4	112-140-162	20.2-18.5-16.2	7.9-9-9.2	150x100
100-310B1	112-140-168	32.5-29.5-25	13-14.1-15.5	150x100
100-310B2	106-133-160	27.5-25.5-22	10.4-11.6-12.8	150x100
100-310B3	100-124-150	23-21.2-18	8.2-9-9.8	150x100
100-310B4	94-117-140	19.4-17-15	6.5-6.9-7.6	150x100
100-375A1	148-185-220	57-51-44.2	31.4-33.5-36	150x100
100-375A2	133-167-200	47.3-46-38	24.5-28.3-29.2	150x100
100-375A3	124-155-186	41-38-31	20.3-22.6-23.1	150x100
100-375A4	108-135-162	32.5-30.3-25.3	14.4-14.5-16.8	150x100
100-375B1	130-162-195	56.2-52-45.8	28.4-31.4-35.9	150x100
100-375B2	114-142-170	47.5-44-39	22.2-23.7-27.3	150x100
100-375B3	105-130-157	40-37.5-32.5	17.7-18.8-21.7	150x100
100-375B4	92-115-138	30.8-28.7-25	12.7-14.3-15.4	150x100

TECHNICAL DATA/DATOS TÉCNICOS/DONNÉES TECHNIQUES

PSC4 50/60Hz n=1450/1750 r/min

TECHNICAL DATA/DATOS TÉCNICOS/DONNÉES TECHNIQUES

PSC4 50/60Hz n=1450/1750 r/min

MODEL MODELO MODÈLE	Flow Range Rango de Caudal Gamme de débit	Head Range Rango de Altura Gamme de tête	Power Range Rango de Potencia Gamme de puissance	DN
125-230A1	220-274-328	17-14.8-12	12.1-12.9-13.1	200x125
125-230A2	193-241-290	15-13.2-10.8	9.7-10.3-10.4	200x125
125-230A3	184-230-277	12.6-10.6-8	8-8.1-8.1	200x125
125-230A4	167-209-250	10.3-8.7-6.8	6.4-6.4-6.4	200x125
125-230B1	190-238-307	17-15.1-11.5	10.5-11.6-12	200x125
125-230B2	170-212-255	15-13.5-11.4	8.6-9.3-9.7	200x125
125-230B3	164-205-246	13-11.5-9.2	7.5-7.8-7.9	200x125
125-230B4	156-195-223	10.5-9.1-7.7	5.9-6.2-6.3	200x125
125-290A1	215-269-323	29.2-27-23.5	20.8-23.6-25.2	200x125
125-290A2	195-243-292	24.4-22-19.6	16.1-17.8-19.5	200x125
125-290A3	178-223-268	20-18-15.5	12.3-13.7-14.4	200x125
125-290A4	161-202-242	16.3-14.2-11.8	9.3-10-10.2	200x125
125-290B1	193-241-290	27.5-25-21.3	17.8-19.8-20.6	200x125
125-290B2	174-218-261	23.4-21-17.5	13.9-15.2-16	200x125
125-290B3	157-196-235	19-17.5-15	10.4-11.8-12.3	200x125
125-290B4	138-173-207	15.1-13.7-11.3	7.7-8.5-8.6	200x125
125-365A1	245-310-360	50-47-44	41.2-47.2-52.3	200x125
125-365A2	225-281-337	41.6-39-35.6	31.8-36-40.4	200x125
125-365A3	205-256-307	33.7-31.5-28.2	24.2-26.8-29.8	200x125
125-365A4	184-230-278	25.5-24-20.9	16.9-18.8-20.2	200x125
125-365B1	222-277-333	46.3-43-38.8	35.4-40.1-44	200x125
125-365B2	202-252-302	39.8-37-32.8	28-31.8-34.2	200x125
125-365B3	182-227-272	32.6-30.5-27.5	21.4-24.5-26.8	200x125
125-365B4	158-198-238	26.3-24.5-21.8	14.9-17.4-18.8	200x125
125-500A1	262-328-393	82-76-70	73.7-82.7-96.4	200x125
125-500A2	233-292-342	70-66.5-62	56.7-67.3-74.8	200x125
125-500A3	205-256-307	60-56-51.5	44-50.6-56.6	200x125
125-500A4	184-230-252	50-47-45	34.2-38.8-40.7	200x125
125-500B1	235-293-352	75-69.5-63	61.7-70.3-78.5	200x125
125-500B2	217-272-326	65-60.5-55	50.1-57.4-64.3	200x125
125-500B3	181-227-272	57-53-48.3	37.5-42.5-47.3	200x125
125-500B4	161-202-234	47.5-45-40	28.2-32.5-34.5	200x125
150-290A1	354-443-531	24-21-17.5	27.1-29.1-30.3	200x150
150-290A2	323-403-484	21-18-15	22.2-23-24	200x150
150-290A3	302-378-454	17.5-15-12.3	18-18.4-19.1	200x150
150-290A4	280-350-396	13.7-11.5-10	13.9-14.2-14.2	200x150
150-290B1	317-396-475	23.4-20.4-16.6	24-25.6-25.7	200x150
150-290B2	302-378-454	20-17-13.7	19.9-20.6-20.7	200x150
150-290B3	282-353-423	17.5-14.5-11.3	16.6-16.6-16.5	200x150
150-290B4	265-331-378	14-11.5-9.8	13-13-13.3	200x150
150-360A1	357-446-536	41.3-38-34.2	48.4-54.3-60.4	200x150
150-360A2	323-403-484	34.2-31-26.3	36.9-41-42.9	200x150
150-360A3	298-370-445	28.7-25-21	29.4-31.2-32.3	200x150
150-360A4	265-331-398	23.4-20-16.7	22.1-23.1-23.3	200x150
150-360B1	325-407-488	39.2-35-30	42.3-46.2-49.3	200x150
150-360B2	294-367-440	33-29.5-25	32.8-36-37.5	200x150
150-360B3	267-334-400	27.5-25-21.3	25.4-28.5-29.8	200x150
150-360B4	233-292-350	22.8-20.5-17.5	19.2-20.9-22	200x150
150-460A1	412-515-618	71-66-60	99.4-112.8-126.2	200x150
150-460A2	377-472-566	58-54.5-48	75.2-86.4-94.9	200x150
150-460A3	346-432-516	47.5-43.5-37	57-64-69.7	200x150
150-460A4	317-396-475	38-35-28.2	42.6-48.1-50.7	200x150
150-460B1	350-440-527	65-60-53.5	78.3-88.6-97.6	200x150
150-460B2	323-403-484	54-50-44.5	60.3-68.2-75.2	200x150
150-460B3	300-375-450	44.4-40-34.5	46.5-51-57.1	200x150
150-460B4	260-324-390	35.3-33-28.4	33.5-37.3-40.7	200x150
150-605A1	467-583-700	112-105-95.5	182.6-206-233.4	200x150
150-605A2	440-550-648	96-88.5-81	151.1-168-187.5	200x150
150-605A3	412-515-605	82-75-68	120-134.8-151.4	200x150
150-605A4	378-472-526	67.5-61.5-55.2	92.3-102.6-106.8	200x150

MODEL MODELO MODÈLE	Flow Range Rango de Caudal Gamme de débit	Head Range Rango de Altura Gamme de tête	Power Range Rango de Potencia Gamme de puissance	DN
150-605B1	430-536-617	98-90-82	149.2-166.4-181.5	200x150
150-605B2	392-490-576	85-78-70	118.9-133.3-148.1	200x150
150-605B3	357-446-535	75-68.5-60	96.2-108.2-118.4	200x150
150-605B4	323-403-484	62.5-57.5-50	73.4-83.1-91.6	200x150
200-320A1	556-695-834	34-30-25	60-64.9-67.2	250x200
200-320A2	518-648-778	29-25.5-21.3	48.8-52-54	250x200
200-320A3	481-601-720	25-21.3-17.2	40.7-41-42.3	250x200
200-320A4	440-550-612	18.9-17-15.3	29-32.3-32.9	250x200
200-320B1	510-637-765	32.3-28-23.4	52.7-56.2-58	250x200
200-320B2	475-594-713	28.5-24.5-20	44-46.1-46.9	250x200
200-320B3	445-558-670	23.8-21-17.2	35.6-38-38.4	250x200
200-320B4	412-515-595	20-17-14.2	28.8-29.1-29.5	250x200
200-420A1	567-709-850	57-52-47	104-116-129	250x200
200-420A2	504-630-756	47.5-42.5-37.5	79.1-86.3-93.1	250x200
200-420A3	458-572-687	40-35.5-30	62-66.7-68.8	250x200
200-420A4	409-511-613	32.5-27.5-24	45.8-49-50.1	250x200
200-420B1	518-648-778	54-48.5-42	90.8-99.1-107	250x200
200-420B2	467-583-700	45-40.5-35	69.8-76.6-81.9	250x200
200-420B3	423-530-635	38-34.5-29	54.8-60.6-63.1	250x200
200-420B4	375-468-562	31.5-28-24	41.5-45.8-47.5	250x200
200-520A1	654-817-980	97-91-83	210-241-272	250x200
200-520A2	605-756-907	82.5-76.5-70	170-192-215	250x200
200-520A3	565-706-847	67-62.5-55	132-148-163	250x200
200-520A4	518-647-778	52.3-47.5-42	98-107-117	250x200
200-520B1	558-734-880	88-81.7-73.2	175-197-219	250x200
200-520B2	556-695-834	74-68-60	141-159-172	250x200
200-520B3	524-655-786	60-55-48.8	109-123-134	250x200
200-520B4	478-598-717	48-43.5-38	81-91-98	250x200
200-670A1	634-792-936	157.5-150-140	350-404-457	250x200
200-670A2	596-745-894	134.5-127-114.5	285-328-367	250x200
200-670A3	562-702-842	114.5-107-95.5	231-266-293	250x200
200-670A4	527-659-770	95.5-88-80	183-208-227	250x200
200-670B1	576-720-864	142-132.5-120	289-329-372	250x200
200-670B2	530-662-795	123-114.5-104	231-263-296	250x200
200-670B3	493-616-720	106-98.5-90	187-212-232	250x200
200-670B4	455-569-683	90-83-73	149-167-184	250x200
250-370A1	840-1051-1260	44-39-33.5	118-127-137	300x250
250-370A2	795-994-1192	37.5-33-27.7	99-104-109	300x250
250-370A3	755-943-1131	31.5-27-21	83-83.6-83.6	300x250
250-370A4	756-871-1008	23-20-16	62.3-61.2-57.8	300x250
250-370B1	823-1029-1235	42.3-37-31	112-119-124	300x250
250-370B2	775-968-1162	37-32-27	94.9-98.1-103.6	300x250
250-370B3	732-914-1097	32-27-22	79.7-80-82.2	300x250
250-370B4	680-850-1020	25.6-22-17	61.6-62.1-61.3	300x250
250-480A1	938-1173-1408	73.5-66-58	222-239-262	300x250
250-480A2	864-1080-1296	60.5-55-47.5	166-188-202	300x250
250-480A3	800-1000-1200	50-45-38	136-149-160	300x250
250-480A4	743-929-1115	42-37.5-32	110-119-126	300x250
250-480B1	864-1044-1296	62-55.5-45	177-191-199	300x250
250-480B2	780-976-1171	53.5-47-42	141-149-163	300x250
250-480B3	708-886-1063	45-40.5-34	111-121-126	300x250
250-480B4	642-803-963	40-34.5-28.5	94.6-96.1-98.4	300x250
250-600A1	994-1242-1490	126-116-105	411-467-520	300x250
250-600A2	933-1166-1400	108-100-90	333-380-421	300x250
250-600A3	867-1084-1300	90-83-73.5	262-295-322	300x250
250-600A4	800-1000-1200	74-66-60	201-218-244	300x250
250-600B1	835-1044-1253	114-104-91.5	320-356-381	300x250
250-600B2	772-965-1158	98-90-80	255-287-311	300x250
250-600B3	700-875-1050	80.3-74.5-66	192-218-235	300x250
250-600B4	640-800-960	67.5-62-56.5	149-168-186	300x250

MODEL MODELO MODÈLE	Flow Range Rango de Caudal Gamme de débit	Head Range Rango de Altura Gamme de tête	Power Range Rango de Potencia Gamme de puissance	DN
250-710A1	904-1130-1356	184-175-164	579-674-775	300x250
250-710A2	782-978-1174	161-152-141	444-513-578	300x250
250-710A3	738-922-1106	136-128-118	358-415-465	300x250
250-710A4	692-865-1038	113-106-99	280-325-360	300x250
300-300A1	878-1098-1318	28.8-24.5-20	83.8-85.2-89.4	350x300
300-300A2	835-1044-1253	23.5-19.8-15	66.4-66.6-63.2	350x300
300-300A3	806-1008-1210	19-15.5-11.4	52.8-51.9-48.2	350x300
300-300A4	772-965-1158	15-11.5-7.5	41.5-37.8-32	350x300
300-300B1	745-936-1123	26.2-23-20	64.4-69-72.9	350x300
300-300B2	691-864-1037	24-20-15.8	56.2-56-55.1	350x300
300-300B3	639-800-960	20-16.7-13.5	45.5-44.9-44.6	350x300
300-300B4	560-700-840	17.5-15-12	37.1-37.1-36.1	350x300
300-435A1	1342-1677-2012	60-53-46	257-275-295	400x300
300-435A2	1262-1577-1892	52-45-37.5	213-223-230	400x300
300-435A3	1181-1476-1771	42.5-36.5-28.5	171-175-172	400x300
300-435A4	1088-1360-1530	33.8-27.5-24	132-129-128	400x300
300-435B1	1396-1620-1944	57.5-51.5-43.5	240-260-273	400x300
300-435B2	1215-1519-1823	51.5-45-37.5	206-215-222	400x300
300-435B3	1138-1422-1706	43.5-37.5-30	168-173-174	400x300
300-435B4	1066-1332-1598	35-30.5-24.8	130-136-138	400x300
300-560A1	1397-1745-2095	101.5-94-83.5	454-520-570	400x300
300-560A2	1316-1645-1974	83.5-76-67	357-398-433	400x300
300-560A3	1258-1573-1888	68-63-54	281-313-339	400x300
300-560A4	1213-1516-1819	57-50-42	232-247-260	400x300
300-560B1	1238-1548-1858	88.5-80-70	359-399-427	400x300
300-560B2	1158-1447-1736	75-67-57	286-316-331	400x300
300-560B3	1089-1361-1633	64-57-50	235-255-2	

## MATERIAL DESCRIPTION/DESCRIPCIÓN DE MATERIAL/DESCRIPTION DU MATÉRIEL

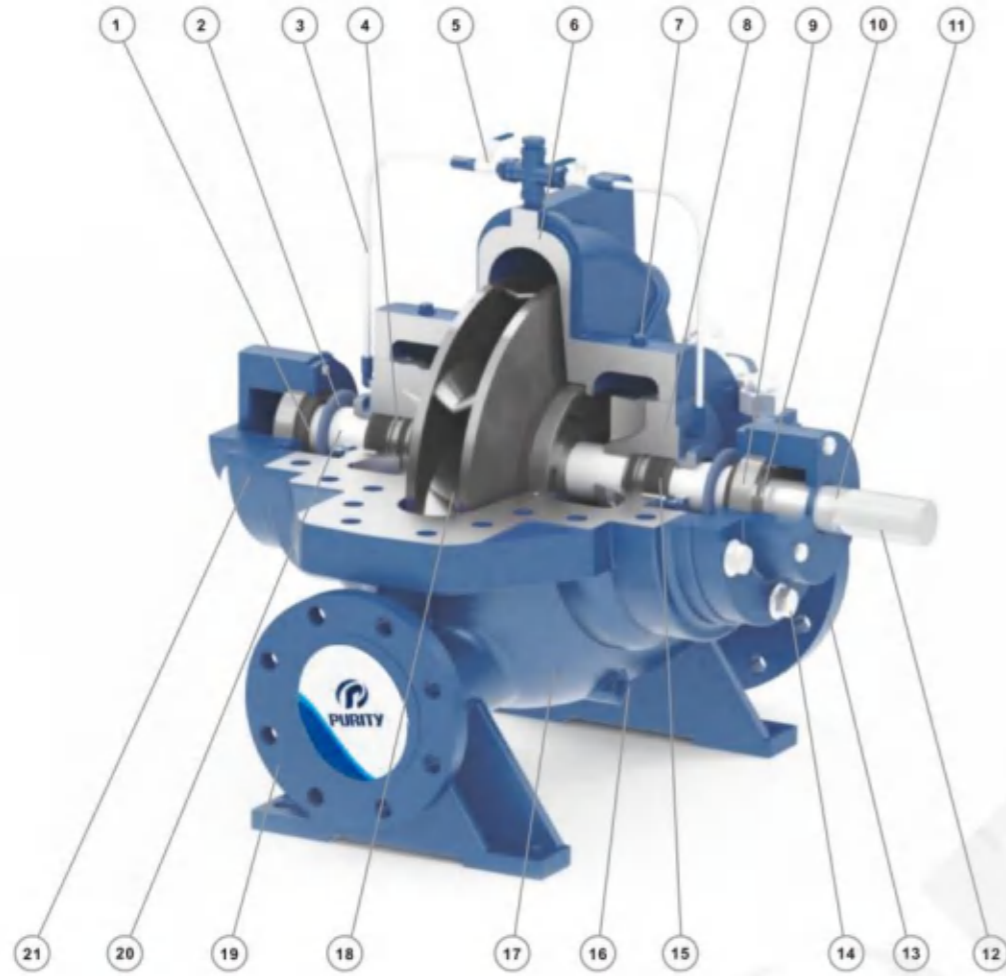

No.	Description Descripción	Material Matériel	No.	Description Descripción	Material Matériel	No.	Description Descripción	Material Matériel
1	Block ring Anillo de bloqueo Bague bloc	Rubber Caucho Caoutchouc	8	Seal house Casa de sello Maison du phoque	Cast iron Fundición Fonte	15	Gland seal/Mechanical Seal Sello glándulas/Cierre Mecánico Joint étoupe/Joint mécanique	Synthepak(SiC-Carbon) Synthepak(SiC-Grafita) Synthepak (SiC-Carbon)
2	O-ring Junta tórica Joint torique	Rubber Caucho Caoutchouc	9	Bearing Rodamiento Palier	Ball Bearing Bola Rodamiento Palier Balle	16	Release Valve Tapón Cebado Soupape de décharge	Brass Bronce Laiton
3	Flushing pipe Tubo de enjuague Tuyau de rinçage	SS304 Inox 304 Inox 304	10	Lock washer Arandela de bloquear Rondelle frein	Steel Acero Acier	17	Pump Case Cuerpo de Bomba Boîtier de pompe	Cast iron Fundición Fonte
4	Packing ring Arandela Anneau d'emballage	Carbon Grafito Carbon	11	Shaft Eje Arbre	SS304/45# Steel Inox 304/45# Hierro Inox304-Acier	18	Impeller Impulsor Roue	SS304/Cast iron Inox 304/Fundición Inox 304/Fonte
5	Valve Valva Soupape	Brass Bronce Laiton	12	Shaft Key Chaveta Eje Clé d'arbre	Iron Hierro Le fer	19	Output flange Brida de salida Bride de sortie	Cast iron Fundición Fonte
6	Pump cover Tapa de bomba Couvercle de pompe	Cast iron Fundición Fonte	13	Input flange Brida de entrada Bride d'entrée	Cast iron Fundición Fonte	20	Shaft sleeve Manga de eje Manchon d'arbre	SS304 Inox 304 Inox 304
7	Vent plug Enchufe de ventilación Bouchon d'aération	Brass Bronce Laiton	14	Bolt Perno Boulon	Steel Acero Acier	21	Bearing house Casa de rodamiento Maison de roulement	Cast iron Fundición Fonte

## DIMENSIONS AND WEIGHT/DIMENSIONES Y PESOS/DIMENSIONS ET POIDS

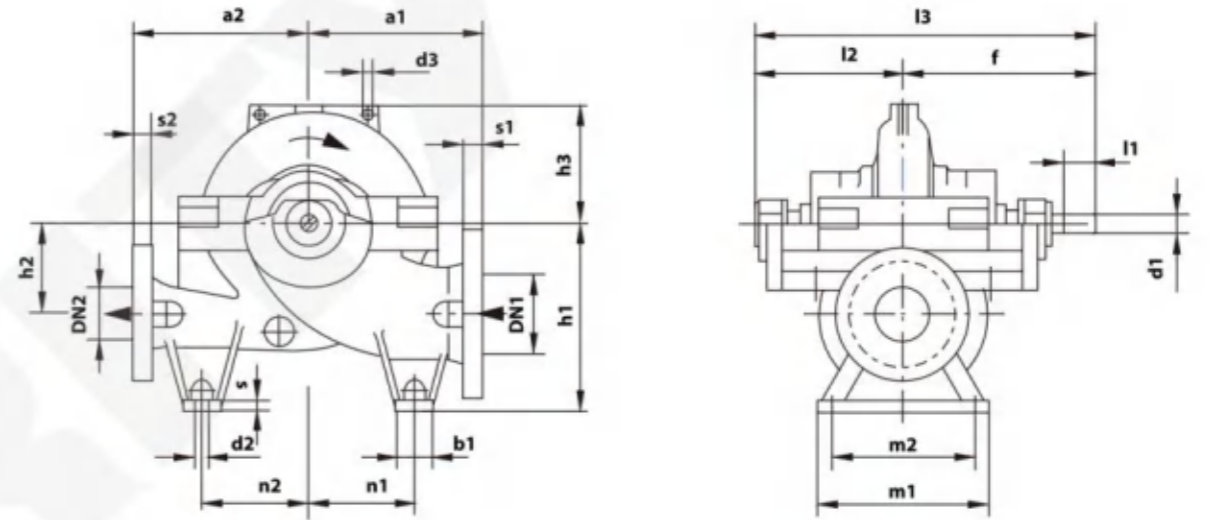

MODEL MODELO MODÈLE	DIMENSIONS/DIMENSIONES/DIMENSIONS mm																	kgs					
	DN1	DN2	s1	s2	a1	a2	d3	f	h1	h2	h3	l2	l3	b1	d2	m1	m2		n1	n2	s	d1	l1
80-210	125	80	34	29	300	300	19	415	315	140	168	300	715	70	17.5	320	270	170	170	20	35	80	185
80-270	125	80	34	29	300	300	19	415	315	140	190	300	715	70	17.5	320	270	170	170	20	35	80	195
80-370	125	80	34	29	330	330	19	415	315	140	225	300	715	70	17.5	320	270	170	170	20	35	80	205
100-250	150	100	37	32	330	330	19	415	355	170	195	300	715	70	17.5	320	270	200	200	20	35	80	210
100-310	150	100	37	32	330	330	19	415	355	170	225	300	715	70	17.5	320	270	200	200	20	35	80	225
100-375	150	100	37	32	370	370	19	415	355	170	260	300	715	70	17.5	320	270	200	200	20	35	80	245
125-230	200	125	41	35	370	370	19	515	400	200	210	366	881	70	17.5	390	340	225	225	20	45	100	250
125-290	200	125	41	35	370	370	19	515	400	200	230	366	881	70	17.5	390	340	225	225	20	45	100	275
125-365	200	125	41	35	370	370	19	515	400	200	260	366	881	70	17.5	390	340	225	225	20	45	100	300
125-500	200	125	41	35	450	450	19	515	400	200	305	366	881	70	17.5	390	340	280	280	20	45	100	335
150-290	200	150	41	37	400	400	19	515	400	200	245	366	881	70	17.5	390	340	225	225	20	45	100	350
150-360	200	150	41	37	400	400	19	515	400	200	265	366	881	70	17.5	390	340	225	225	20	45	100	360
150-460	200	150	41	37	450	450	19	590	400	200	305	399	989	70	17.5	480	430	280	280	20	55	125	440
150-605	200	150	41	37	600	500	19	590	500	300	370	399	989	70	17.5	480	430	350	380	20	55	125	650
200-320	250	200	48	41	450	450	24.5	590	500	240	285	399	989	70	17.5	480	430	280	280	20	55	125	450
200-420	250	200	48	41	500	500	24.5	590	500	240	310	399	989	70	17.5	480	430	280	280	20	55	125	520
200-520	250	200	48	41	600	500	24.5	655	560	300	370	464	1119	70	22	480	400	350	350	26	65	140	840
200-670	250	200	48	41	650	550	24.5	655	600	350	430	464	1119	100	22	480	400	350	350	26	65	140	990
250-370	300	250	33	32	500	500	12.5	655	600	300	320	464	1119	100	22	480	400	350	350	26	65	140	665
250-480	300	250	51	48	550	550	12.5	730	600	300	355	515	1245	100	22	600	520	350	350	26	75	160	830
250-600	300	250	51	48	650	550	12.5	730	630	350	415	515	1245	100	22	600	520	350	350	26	75	160	1215
300-300	350	300	36	33	550	500	24.5	655	630	300	360	464	1119	100	22	480	400	350	350	26	65	140	630
300-435	400	300	38	33	650	550	24.5	730	670	350	365	515	1245	100	22	600	520	350	350	26	75	160	905
300-560	400	300	57	51	700	650	24.5	810	710	350	430	585	1395	100	22	600	520	475	475	26	85	180	1425
300-700	400	300	57	51	750	650	24.5	810	750	400	480	585	1395	100	22	600	520	475	475	26	85	180	1690
350-360	400	350	38	36	650	550	24.5	730	670	350	410	515	1245	100	22	600	520	350	350	26	75	160	865
350-430	450	350	41	36	750	650	24.5	810	750	400	465	585	1395	100	22	600	520	475	475	26	85	180	1285
350-510	400	350	38	36	700	650	24.5	810	750	400	420	585	1395	100	22	600	520	475	475	26	85	180	1395



# PXZ

**Self-priming centrifugal pump**  
**Bomba centrífuga autocebante**  
**Pompe centrifuge auto-amorçante**



## NEW/NUEVO/NOUVEAU

### DESCRIPTION/DESCRIPCIONES/DESCRIPTION

- ◆ New self-priming centrifugal pump design
  - ◆ Original design by PURITY (patented no. 201530016935.4)
  - ◆ YE3 high efficient motor, with protection IP55 class F
  - ◆ Pump case with anti-corrosive coating
  - ◆ Impeller in stainless steel AISI 304 or cast iron
  - ◆ Suction and discharge port in G20 thread
  - ◆ Quality NSK bearing, wear resistance mechanical seal
- ◆ Nuevo diseño de bomba centrífuga autocebante
  - ◆ Diseño original de PURITY (patentado no. 201530016935.4)
  - ◆ Motor de alta eficiencia YE3, con protección IP55 clase F
  - ◆ Caja de bomba con revestimiento anticorrosivo
  - ◆ Impulsor en acero inoxidable 304 o hierro fundido
  - ◆ Puerto de succión y descarga en rosca G20
  - ◆ Rodamiento de marca NSK y cierre mecánico personalizado
- ◆ Nouvelle conception de pompe centrifuge auto-amorçante
  - ◆ Design original par PURITY (breveté no. 201530016935.4)
  - ◆ Moteur haute efficacité YE3, avec protection IP55 classe F
  - ◆ Boîtier de pompe avec revêtement anti-corrosif
  - ◆ Roue en acier inoxydable 304 ou en fonte
  - ◆ Orifice d'aspiration et de refoulement en filetage G20
  - ◆ Roulement NSK qualité, joint mécanique de résistance à l'usure

## APPLICATIONS/APLICACIONES/APPLICATIONS

- ◆ Suitable for use with liquids that are not chemically aggressive towards the materials from which the pump is made. The self-priming centrifugal pumps are recommended for use in water supply systems, washing systems, pressure systems, irrigation pumps, liquids transfer.
- ◆ Adecuado para usar con líquidos que no son químicamente agresivos con los materiales de los que está hecha la bomba. Las bombas centrífugas autocebantes se recomiendan para su uso en sistemas de suministro de agua, sistemas de lavado, sistemas de presión, bombas de riego, transferencia de líquidos.
- ◆ Convient pour une utilisation avec des liquides qui ne sont pas chimiquement agressifs envers les matériaux à partir desquels la pompe est fabriquée. Les pompes centrifuges auto-amorçantes sont recommandées pour une utilisation dans les systèmes d'alimentation en eau, les systèmes de lavage, les systèmes de pression, les pompes d'irrigation, le transfert de liquides.

## USING LIMITS/LÍMITES UTILIZACIÓN/UTILISATION LIMITES

- ◆ Liquid temperature between **-10°C** and **+120°C**
- ◆ Ambient temperature up to **+50°C**
- ◆ Max. working pressure **16 bar**
- ◆ Continuous service **S1**
- ◆ Temperatura del líquido de **-10 °C** hasta **+120 °C**
- ◆ Temperatura ambiente hasta **+50 °C**
- ◆ Presión máxima en el cuerpo de la bomba **16 bar**
- ◆ Funcionamiento continuo **S1**
- ◆ Température du liquide entre **-10 °C** et **+120 °C**
- ◆ Température ambiante jusqu'à **+50 °C**
- ◆ Max. pression de service **16 bar**
- ◆ Service continu **S1**

## TECHNICAL DATA/DATOS TÉCNICOS/DONNÉES TECHNIQUES

60Hz n=3500 r/min

MODEL MODELO MODÈLE	Power Potencia/Puissance		Max Q m³/h	Max H m	Rated Q m³/h	Rated H m	Suction H m	Impeller Impulsor Roue	DN mm
	kw	hp							
PXZ15-30-1.5	1.5	2	15	30	8	23	8	SS304 / inox304 / inox304	40
PXZ(D)15-30-1.5	1.5	2	15	30	8	23	8	SS304 / inox304 / inox304	40
PXZ18-28-1.5	1.5	2	18	28	10	20	8	SS304 / inox304 / inox304	50
PXZ(D)18-28-1.5	1.5	2	18	28	10	20	8	SS304 / inox304 / inox304	50
PXZ18-35-2.2	2.2	3	18	35	10	25	8	SS304 / inox304 / inox304	40
PXZ(D)18-35-2.2	2.2	3	18	35	10	25	8	SS304 / inox304 / inox304	40
PXZ20-32-2.2	2.2	3	20	32	12	22	8	SS304 / inox304 / inox304	50
PXZ(D)20-32-2.2	2.2	3	20	32	12	22	8	SS304 / inox304 / inox304	50
PXZ22-40-3	3	4	22	40	12	28	8	SS304 / inox304 / inox304	50
PXZ(D)22-40-3	3	4	22	40	12	28	8	SS304 / inox304 / inox304	50
PXZ25-45-4	4	5.5	25	45	15	30	8	SS304 / inox304 / inox304	50
PXZW15-25-1.5	1.5	2	15	25	10	18	8	Cast iron / Fundicion / Fonte	50
PXZW(D)15-25-1.5	1.5	2	15	25	10	18	8	Cast iron / Fundicion / Fonte	50
PXZW18-30-2.2	2.2	3	18	30	10	20	8	Cast iron / Fundicion / Fonte	50
PXZW(D)18-30-2.2	2.2	3	18	30	10	20	8	Cast iron / Fundicion / Fonte	50
PXZW25-35-3	3	4	25	35	12	22	8	Cast iron / Fundicion / Fonte	50
PXZW(D)25-35-3	3	4	25	35	12	22	8	Cast iron / Fundicion / Fonte	50
PXZW28-38-4	4	5.5	28	38	15	25	8	Cast iron / Fundicion / Fonte	50

W= Sewage water available/Agua sucia disponible/Eaux usées disponibles

## MATERIAL DESCRIPTION/DESCRIPCIÓN DE MATERIAL/DESCRIPTION DU MATÉRIEL

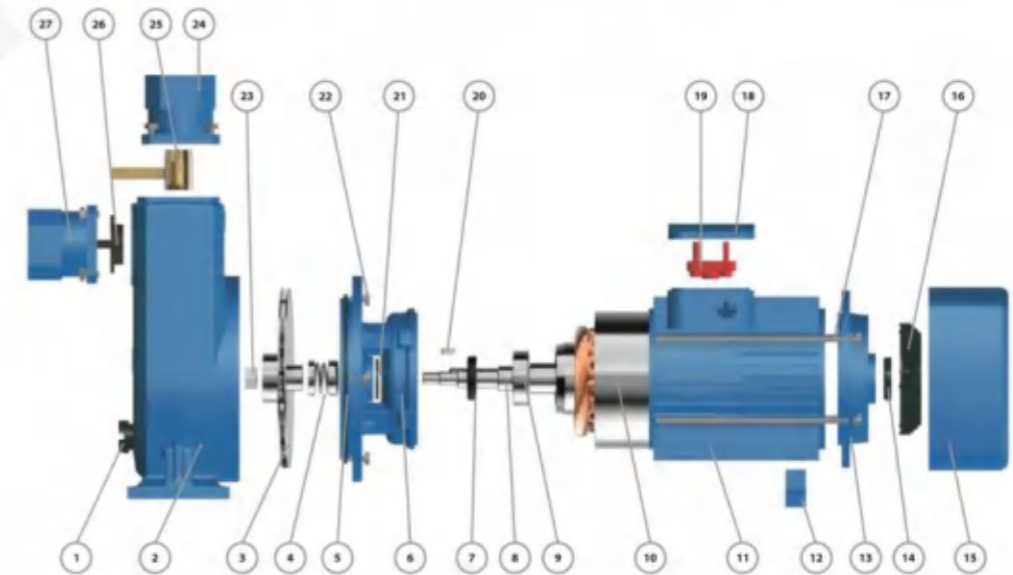

No.	Description Descripción Description	Material Material Matériel	No.	Description Descripción Description	Material Material Matériel	No.	Description Descripción Description	Material Material Matériel
1	Release Valve Tapón/Cebado Soupape de décharge	Plastic Plástico Plastique	10	Wound Stator/Rotor Estator/Rotor Stator/Rotor	Silicon Steel/Copper Silicio-Cobre Silicium-Cuivre	19	Terminal Board Tablero Bornas Bornier	Plastic Plástico Plastique
2	Pump Case Cuerpo de Bomba Boîtier de pompe	Cast iron Fundición Fonte	11	Motor Case Cuerpo Motor Boîtier Moteur	Aluminum Aluminio Aluminium	20	Impeller Key Chaveta Clé	Iron Hierro Le fer
3	Impeller Impulsor Roue	SS304/Cast iron Inox 304/Fundición Inox 304/Fonte	12	Support Foot Soporte Pie Pied support	Plastic Plástico Plastique	21	Water Deflector Deflector Déflecteur	Rubber Caucho Caoutchouc
4	Mechanical Seal Cierre Mecánico Sceller	SiC/Carbon/SS304 SiC/Grafito/Inox304 SiC/Carbon/Inox304	13	Back Cover Tapa Trasera Capot Arrière	Cast iron Fundición Fonte	22	Connection Bolt Perno Boulon de connexion	Steel Acero Acier
5	O-ring Junta Tórica Joint Torique	Rubber Caucho Caoutchouc	14	Reinforced Seal Sello Reforzado Sceller	Rubber Caucho Caoutchouc	23	Impeller Nut Nuez Noix	Galvanized Steel Acero Galvanizado Acier Galvanisé
6	Connection Conexión	Cast iron Fundición Fonte	15	Fan Cover Tapa Capot	Aluminum Aluminio Aluminium	24	Discharge Descarga Décharge	Cast iron Fundición Fonte
7	Reinforced Seal Sello Reforzado Sceller	Rubber Caucho Caoutchouc	16	Fan Ventilador Ventilateur	Plastic Plástico Plastique	25	Ball Valve Válvula Bola Vanne à bille	Brass Bronce Laiton
8	Shaft Eje Arbre	SS304-45# Steel Inox 304-Hierro Inox304-Acier	17	Through Bolt Perno Boulon	Steel Acero Acier	26	Check Valve Válvula Retención Clapet anti-retour	Brass Bronce Laiton
9	Bearing Rodamiento Palier	Ball Bearing Bola/Rodamiento Palier/Balle	18	Terminal Box Caja Bornas Boîte Bornes	Aluminum Aluminio Aluminium	27	Suction Succión Suction	Cast iron Fundición Fonte

PZW

**Self-priming non-blocking sewage pump**  
**Bomba de aguas residuales autocebante**  
**Pompe d'égout autobloquante non bloquante**



**NEW/NUEVO/NOUVEAU**

**DESCRIPTION/DESCRIPCIONES/DESCRIPTION**

- ◆ Self-priming non-blocking sewage pump design
  - ◆ Impeller in two vanes, non-clogging, close but big fluid channels
  - ◆ Bare shaft pump separate or coupled with motor both available
  - ◆ Stainless steel 304 all wetted parts available for all models
  - ◆ High efficiency thanks to the excellent hydraulic model is adopted
  - ◆ Strong drainage capacity with non-blocking design
  - ◆ Good self-priming performance 4.5-6.0m
- ◆ *Diseño de bomba de aguas residuales sin bloqueo autocebante*
  - ◆ *Impulsor en dos paletas, sin obstrucción, tipo de canales grande*
  - ◆ *Bomba de eje desnudo separada o acoplada con motor*
  - ◆ *Inox 304 todas las partes húmedas disponibles para todos los modelos*
  - ◆ *Alta eficiencia gracias al excelente modelo hidráulico adoptado*
  - ◆ *Fuerte capacidad de drenaje con diseño sin bloqueo*
  - ◆ *Buen rendimiento de autocebado 4.5-6.0m*
- ◆ *Conception de pompe d'égout autobloquante non bloquante*
  - ◆ *Roue à deux aubes, non obstruante, type à canaux gros*
  - ◆ *Pompe à arbre nu séparée ou couplée au moteur disponible*
  - ◆ *Inox304 toutes les pièces mouillées disponibles pour tous les modèles*
  - ◆ *D'un rendement élevé grâce à l'excellent modèle hydraulique*
  - ◆ *Forte capacité de drainage avec une conception non bloquante*
  - ◆ *Bonne performance d'auto-amorçage 4.5-6.0 m*

**APPLICATIONS/APLICACIONES/APPLICATIONS**

- ◆ A liquid storage chamber is provided in the pump body, suitable for chemical, petroleum, pharmaceutical, mining, papermaking, fiber, pulp, textile, food, power plant and municipal sewage works, public facilities sewage, river pond breeding and other industries.
- ◆ *Se proporciona una cámara de almacenamiento de líquidos en el cuerpo de la bomba, adecuada para químicos, petróleo, farmacéuticos, minería, fabricación de papel, fibra, pulpa, textiles, alimentos, plantas de energía y obras de alcantarillado municipal, alcantarillado de instalaciones públicas, cría de estanques de ríos y otras industrias.*
- ◆ *Une chambre de stockage de liquide est fournie dans le corps de la pompe, adaptée aux produits chimiques, pétroliers, pharmaceutiques, miniers, papetiers, aux fibres, à la pâte, au textile, à l'alimentation, aux centrales électriques et aux réseaux d'égouts municipaux, aux eaux usées des installations publiques, à l'élevage d'étangs fluviaux et à d'autres industries.*

**USING LIMITS/LÍMITES UTILIZACIÓN/UTILISATION LIMITES**

- ◆ Liquid temperature between **-10°C** and **+80°C**
- ◆ Ambient temperature between **-10°C** and **+50°C**
- ◆ **PH 6-9** for cast iron, **2-13** for stainless steel
- ◆ Media weight not exceed **1240 kg / m<sup>3</sup>**
- ◆ *Temperatura del líquido entre -10°C y +80°C*
- ◆ *Temperatura ambiente entre -10°C y +50°C*
- ◆ *PH 6-9 para hierro fundido, 2-13 para acero inoxidable*
- ◆ *El peso del medio no excede 1240 kg / m<sup>3</sup>*
- ◆ *Température du liquide entre -10°C et +80°C*
- ◆ *Température ambiante entre -10°C et +50°C*
- ◆ *PH 6-9 pour la fonte, 2-13 pour l'acier inoxydable*
- ◆ *Le poids du support ne dépasse pas 1240 kg / m<sup>3</sup>*

**MODEL CODE/CÓDIGO MODELO/CODE MODÈLE**

For example/ Por ejemplo/ Par exemple

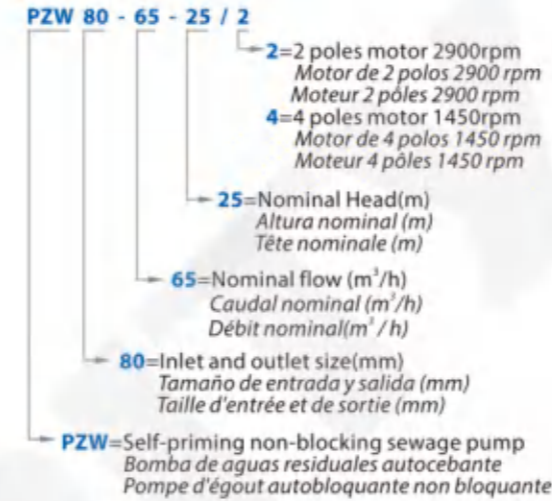

**TECHNICAL SHEET/HOJA TÉCNICA/FICHE TECHNIQUE**

Model/Modelo/Modèle	PZW	
Capacity/Caudal/Débit	0-800	m <sup>3</sup> /h
Head/Altura/Hauteur	0-80	m
DN	25-300	mm
Speed/Velocidad/Vitesse	3500/1750	rpm
T max	80	°C
Power/Potencia/Puiss.	1.5-75	kW
Voltage/Voltaje/Tension	220/380/400/440	V
HZ	60	
Class/Clase/Classe	Class F	
IP	IP 55	
Duty/Servicio/Devoir	S1 continuous	

**TECHNICAL DATA/DATOS TÉCNICOS/DONNÉES TECHNIQUES**

60Hz n=3500/1750 r/min

MODEL MODELO MODÈLE	Power Potencia Puissance		DN mm	Flow Caudal Débit m <sup>3</sup> /h	Head Altura Hauteur m	Pump/Bomba/Pompe DIM.(mm)		
	kW	hp				L	W	H
PZW25-8-15/2	1.5	2	25x25	8	15	440	280	470
PZW32-5-20/2	2.2	3	32x32	5	20	440	280	470
PZW32-9-30/2	3	4	32x32	9	30	480	310	530
PZW40-10-20/2	2.2	3	40x40	10	20	440	280	470
PZW40-15-30/2	3	4	40x40	15	30	480	310	530
PZW50-10-20/2	2.2	3	50x50	10	20	440	280	470
PZW50-20-15/2	2.2	3	50x50	20	15	440	280	470
PZW50-18-22/2	3	4	50x50	18	22	480	310	530
PZW50-15-30/2	3	4	50x50	15	30	480	310	530
PZW50-20-35/2	5.5	7.5	50x50	20	35	680	350	630
PZW50-20-40/2	7.5	10	50x50	20	40	660	330	640
PZW50-20-50/2	11	15	50x50	20	50	680	420	650
PZW65-30-18/2	4	5.5	65x65	30	18	500	330	530
PZW65-30-18/4	4	5.5	65x65	30	18	680	340	680
PZW65-25-30/2	5.5	7.5	65x65	25	30	660	330	640
PZW65-25-40/2	7.5	10	65x65	25	40	660	330	640
PZW65-25-50/2	11	15	65x65	25	50	680	420	650
PZW65-40-25/2	7.5	10	65x65	40	25	660	330	640
PZW80-40-16/2	4	5.5	80x80	40	16	500	330	530
PZW80-40-16/4	4	5.5	80x80	40	16	680	340	680
PZW80-25-40/2	7.5	10	80x80	25	40	660	330	640
PZW80-50-15/2	5.5	7.5	80x80	50	15	590	335	590
PZW80-65-25/2	7.5	10	80x80	65	25	590	335	590
PZW80-50-30/2	11	15	80x80	50	30	680	340	680
PZW80-80-35/2	15	20	80x80	80	35	750	450	730
PZW80-50-60/2	22	30	80x80	50	60	720	430	700

MODEL MODELO MODÈLE	Power Potencia Puissance		DN mm	Flow Caudal Débit m <sup>3</sup> /h	Head Altura Hauteur m	Pump/Bomba/Pompe DIM.(mm)		
	kW	hp				L	W	H
PZW100-100-10/4	5.5	7.5	100x100	100	10	790	425	800
PZW100-80-20/4	7.5	10	100x100	80	20	790	425	800
PZW100-100-15/4	7.5	10	100x100	100	15	790	425	800
PZW100-100-15/2	11	15	100x100	100	15	790	425	800
PZW100-100-20/2	15	20	100x100	100	20	860	450	820
PZW100-100-20/4	11	15	100x100	100	20	810	450	880
PZW100-100-30/2	22	30	100x100	100	30	860	450	820
PZW100-80-45/2	30	40	100x100	80	45	825	550	840
PZW100-80-60/2	37	50	100x100	80	60	825	550	840
PZW100-80-80/2	45	60	100x100	80	80	825	550	840
PZW125-120-20/4	15	20	125x125	120	20	810	450	880
PZW150-180-10/4	11	15	150x150	180	10	810	450	880
PZW150-180-14/4	15	20	150x150	180	14	810	450	880
PZW150-180-20/4	18.5	25	150x150	180	20	810	450	880
PZW150-180-30/4	30	40	150x150	180	30	870	550	990
PZW150-180-35/4	37	50	150x150	180	35	950	650	1065
PZW150-180-38/4	45	60	150x150	180	38	1020	580	930
PZW150-180-45/4	55	75	150x150	180	45	950	650	1065
PZW200-280-14/4	22	30	200x200	280	14	1040	510	1020
PZW200-280-20/4	37	50	200x200	280	20	1040	560	1020
PZW200-280-25/4	45	60	200x200	280	25	1040	560	1020
PZW200-280-28/4	55	75	200x200	280	28	1230	520	1030
PZW250-420-14/4	45	60	250x250	420	14	1060	680	1100
PZW250-420-20/4	55	75	250x250	420	20	1060	680	1100
PZW300-800-14/4	55	75	300x300	800	14	1500	680	1350
PZW300-800-20/4	75	100	300x300	800	20	1500	680	1350

**WQV**



**Vortex cutting submersible pump**  
**Vórtice bomba sumergible de corte**  
**Pompe submersible de coupe Vortex**



**NEW/NUEVO/NOUVEAU**

**DESCRIPTION/DESCRIPCIONES/DESCRIPTION**

- New cutting submersible sewage pumps design
  - Equipped with vortex alloy impeller with 48HR(hardness)
  - Better hydraulic characteristics
  - Pump case in heavy gauge robust cast iron HT250
  - Casing resistant to abrasion and long-lasting
  - Discharge port with bolts,nuts and gastkets
  - Quality NSK bearing, wear resistance mechanical seal
- Nuevo diseño de bombas sumergibles corte para aguas residuales
  - Equipado con impulsor de aleación vortex con 48HR (dureza)
  - Mejores características hidráulicas
  - Caja de bomba en hierro fundido robusto de gran calibre HT250
  - Carcasa resistente a la abrasión y duradera.
  - Puerto de descarga con pernos, tuercas y empalmes
  - Rodamiento de marca NSK y cierre mecánico personalizado
- Nouvelle conception de pompes submersibles coupe pour eaux usées
  - Équipé d'une roue en alliage vortex avec 48HR (dureté)
  - Meilleures caractéristiques hydrauliques
  - Carter de pompe en fonte robuste de fort calibre HT250
  - Boîtier résistant à l'abrasion et durable
  - Orifice de décharge avec boulons, écrous et joints
  - Roulement NSK qualité, joint mécanique de résistance à l'usure

**USING LIMITS/LÍMITES UTILIZACIÓN/UTILISATION LIMITES**

- Temperature of the liquid to **+40 °C**
  - **10m** maximum immersion depth
  - Solids passage: from **25mm** to **65mm**
- Temperatura del líquido a **+40 °C**
  - **10m** de profundidad de inmersión máxima
  - Paso de sólidos: de **25 mm** a **65 mm**
- Température du liquide à **+40 °C**
  - Profondeur d'immersion maximale de **10m**
  - Passage des solides: de **25 mm** à **65 mm**

**APPLICATIONS/APLICACIONES/APPLICATIONS**

- Drainage Systems Of Urban Sewage Treatment Plants, Hospitals And Hotels.
- Discharge Of Seriously Polluted Wastewater From Factories And Businesses.
- Water Supply Device Of Waterworks.
- Sewage Drainage Station In Residential Area.
- Civil Air Defense System Drainage Station.
- Municipal Engineering, Construction Site Water Supply And Drainage System.
- Rural Biogas Digesters, Agricultural Irrigation, River Dredging.
- Exploration, Mining Supporting Machine.

**MODEL CODE/CÓDIGO MODELO/CODE MODÈLE**



**IMPELLER TYPE/TIPO DE IMPULSOR/TYPE ROUE**

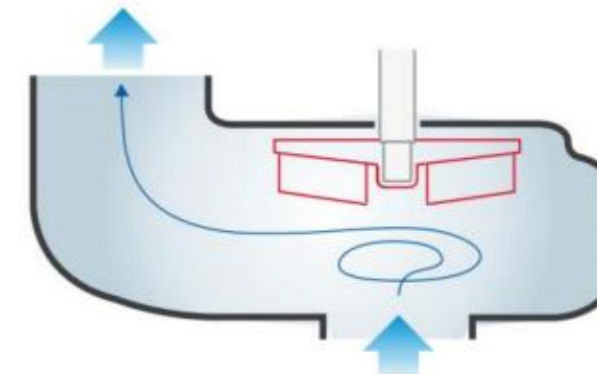

**VORTEX**

**PERFORMANCE CURVE/CURVA DE RENDIMIENTO/COURBE DE PERFORMANCE**

60HZ n=3500/1750 r/min

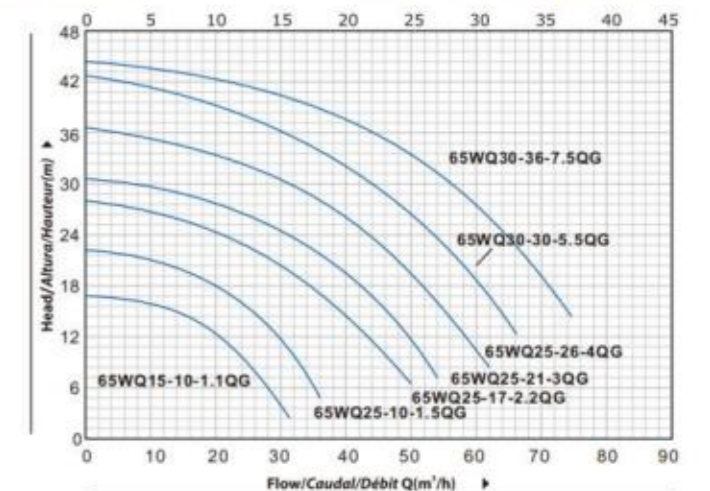
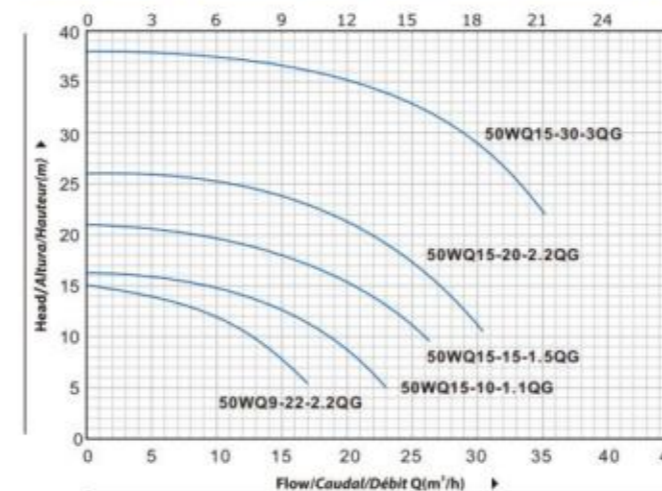



## TECHNICAL DATA/DATOS TÉCNICOS/DONNÉES TECHNIQUES

60Hz n=3500/1750 r/min

MODEL/MODELO/MODÈLE		Power Potencia/Puissance		Rated Q	Rated H	RPM	DN
Single-phase Monofásico/Monophasé	Three-phase Trifásico/Triphasé	hp	kw	m³/h	m		mm
50WQD10-10-0.75QG/2	50WQ10-10-0.75QG/2	1	0.75	10	10	3500	50
50WQD15-10-1.1QG/2	50WQ15-10-1.1QG/2	1.5	1.1	15	10	3500	50
65WQD15-10-1.1QG/2	65WQ15-10-1.1QG/2	1.5	1.1	15	10	3500	65
50WQD15-15-1.5QG/2	50WQ15-15-1.5QG/2	2	1.5	15	15	3500	50
65WQD25-10-1.5QG/2	65WQ25-10-1.5QG/2	2	1.5	25	10	3500	65
50WQ9-22-2.2QG/2	50WQ9-22-2.2QG/2	3	2.2	9	22	3500	50
50WQ15-20-2.2QG/2	50WQ15-20-2.2QG/2	3	2.2	15	20	3500	50
65WQ25-17-2.2QG/2	65WQ25-17-2.2QG/2	3	2.2	25	17	3500	65
80WQ45-9-2.2QG/2	80WQ45-9-2.2QG/2	3	2.2	45	9	3500	80
-	50WQ15-30-3QG/2	4	3	15	30	3500	50
-	65WQ25-21-3QG/2	4	3	25	21	3500	65
-	80WQ43-13-3QG/2	4	3	43	13	3500	80
-	65WQ25-26-4QG/2	5.5	4	25	26	3500	65
-	80WQ45-17-4QG/2	5.5	4	45	17	3500	80
-	100WQ65-12-4QG/2	5.5	4	65	12	3500	100
-	65WQ30-30-5.5QG/2	7.5	5.5	30	30	3500	65
-	80WQ40-23-5.5QG/2	7.5	5.5	40	23	3500	80
-	100WQ65-15-5.5QG/2	7.5	5.5	65	15	3500	100
-	65WQ30-36-7.5QG/2	10	7.5	30	36	3500	65
-	80WQ45-28-7.5QG/2	10	7.5	45	28	3500	80
-	100WQ65-23-7.5QG/2	10	7.5	65	23	3500	100
-	150WQ100-12-7.5QG/2	10	7.5	100	12	3500	150
-	80WQV50-30-11/2	15	11	50	30	3500	80
-	100WQV80-25-11/2	15	11	80	25	3500	100
-	150WQV100-20-11/2	15	11	100	20	3500	150
-	200WQV180-11-11/2	15	11	180	11	3500	200
-	80WQV60-40-15/2	20	15	60	40	3500	80
-	100WQV100-30-15/2	20	15	100	30	3500	100
-	150WQV120-25-15/2	20	15	120	25	3500	150
-	200WQV180-15-15/2	20	15	180	15	3500	200
-	80WQV60-45-18.5/2	25	18.5	60	45	3500	80
-	100WQV80-40-18.5/2	25	18.5	80	40	3500	100
-	150WQV100-36-18.5/2	25	18.5	100	36	3500	150
-	200WQV180-18-18.5/2	25	18.5	180	18	3500	200
-	80WQV60-50-22/2	30	22	60	50	3500	80
-	100WQV80-45-22/2	30	22	80	45	3500	100
-	150WQV100-40-22/2	30	22	100	40	3500	150
-	200WQV200-20-22/2	30	22	200	20	3500	200
-	80WQV80-25-11/4	15	11	80	25	1750	80
-	100WQV80-25-11/4	15	11	80	25	1750	100

## TECHNICAL DATA/DATOS TÉCNICOS/DONNÉES TECHNIQUES

60Hz n=3500/1750 r/min

MODEL/MODELO/MODÈLE		Power Potencia/Puissance		Rated Q	Rated H	RPM	DN
Single-phase Monofásico/Monophasé	Three-phase Trifásico/Triphasé	hp	kw	m³/h	m		mm
-	150WQV150-15-11/4	15	11	150	15	1750	150
-	200WQV180-11-11/4	15	11	180	11	1750	200
-	80WQV80-30-15/4	20	15	80	30	1750	80
-	100WQV80-30-15/4	20	15	80	30	1750	100
-	150WQV200-15-15/4	20	15	200	30	1750	150
-	200WQV250-11-15/2	20	15	250	15	1750	200
-	150WQV250-15-18.5/4	25	18.5	250	11	1750	150
-	200WQV350-12-18.5/4	25	18.5	350	12	1750	200
-	150WQV300-15-22/4	30	22	300	15	1750	150
-	200WQV400-10-22/4	30	22	400	10	1750	220
-	200WQV250-21-30/4	40	30	250	21	1750	250
-	250WQV450-15-30/4	40	30	450	15	1750	250
-	300WQV600-10-30/4	40	30	600	10	1750	300

## PERFORMANCE CURVE/CURVA DE RENDIMIENTO/COURBE DE PERFORMANCE

60Hz n=3500 r/min

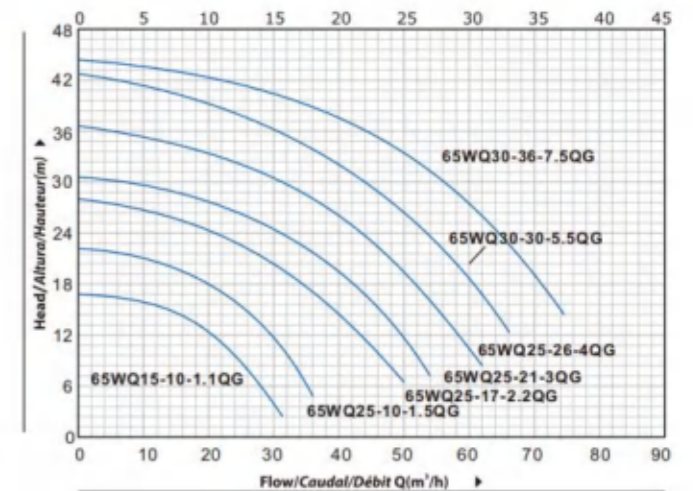
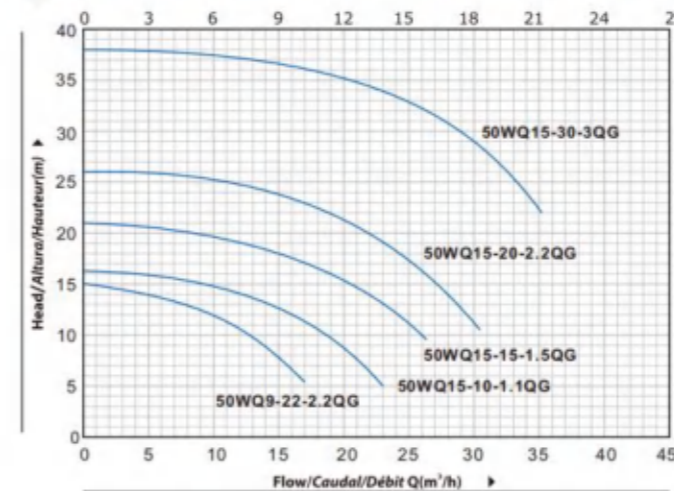

## PERFORMANCE CURVE/CURVA DE RENDIMIENTO/COURBE DE PERFORMANCE

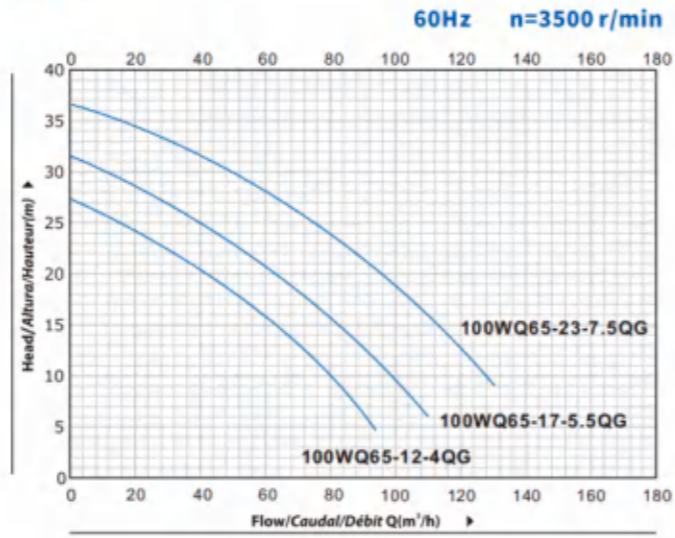
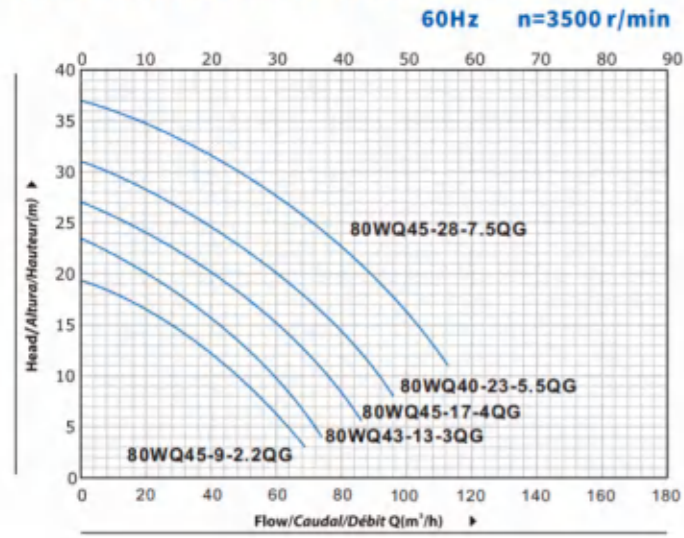

## PERFORMANCE CURVE/CURVA DE RENDIMIENTO/COURBE DE PERFORMANCE

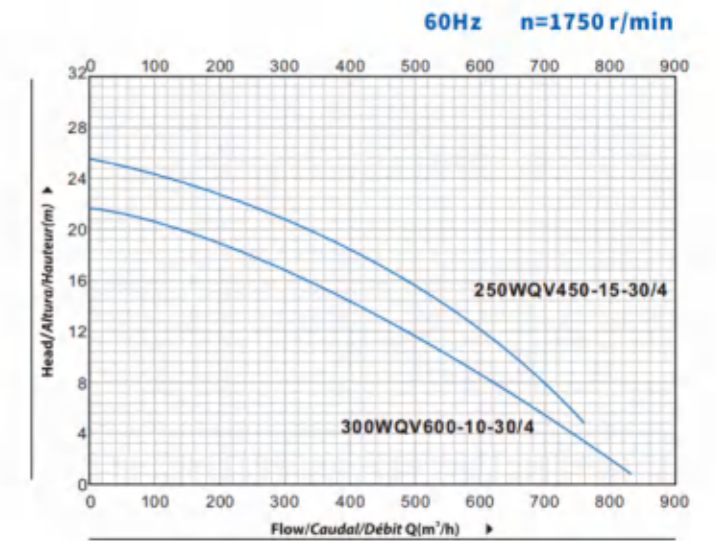
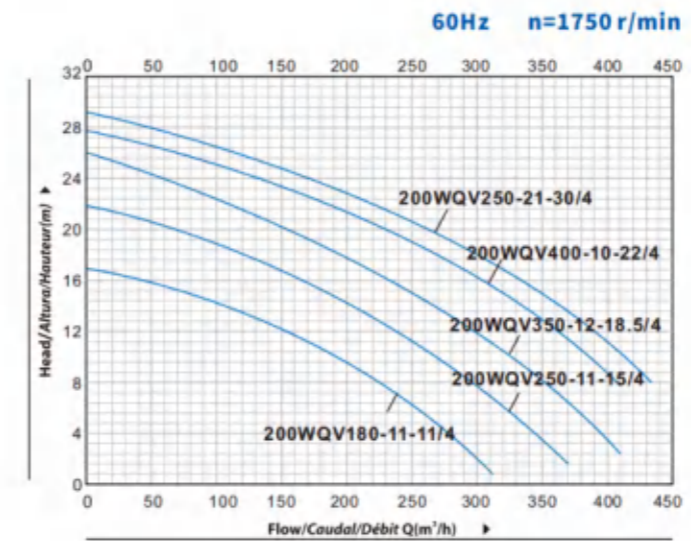
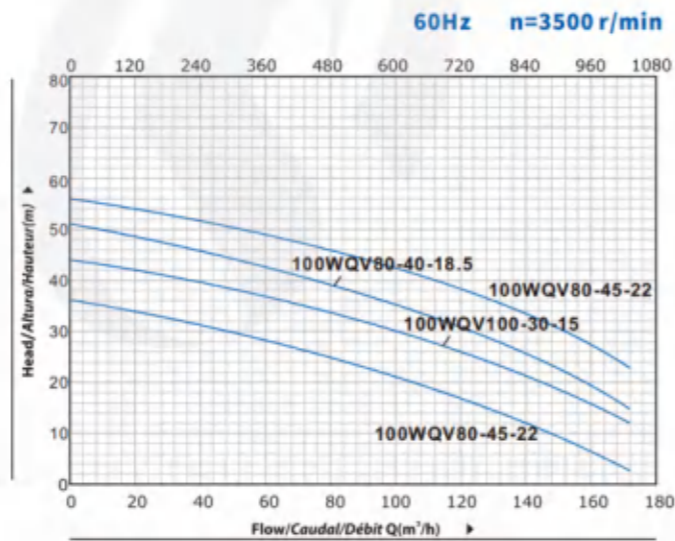
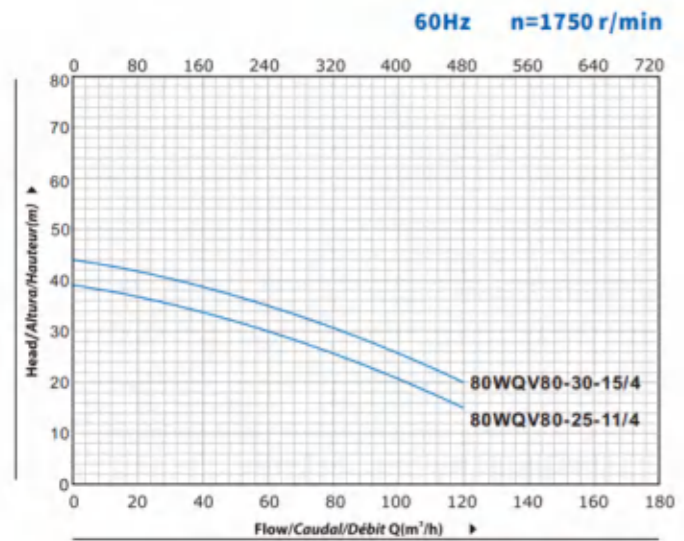
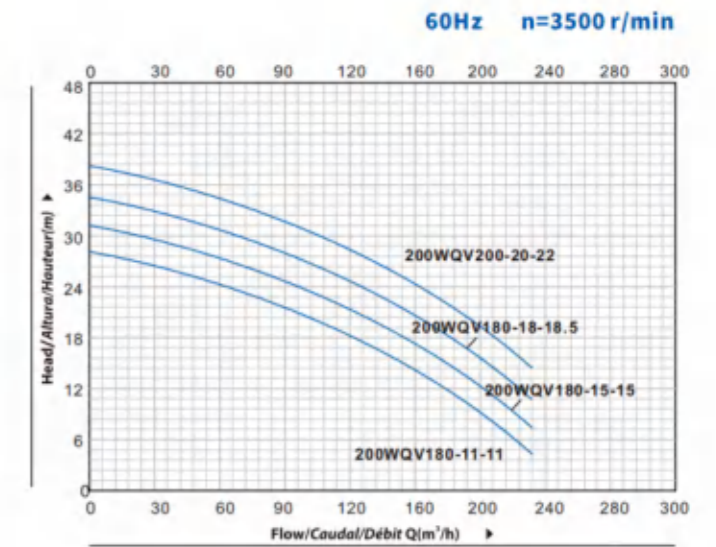
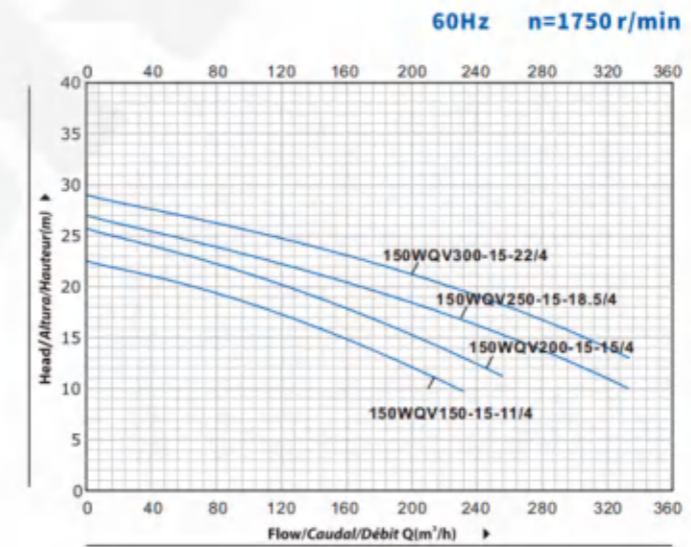
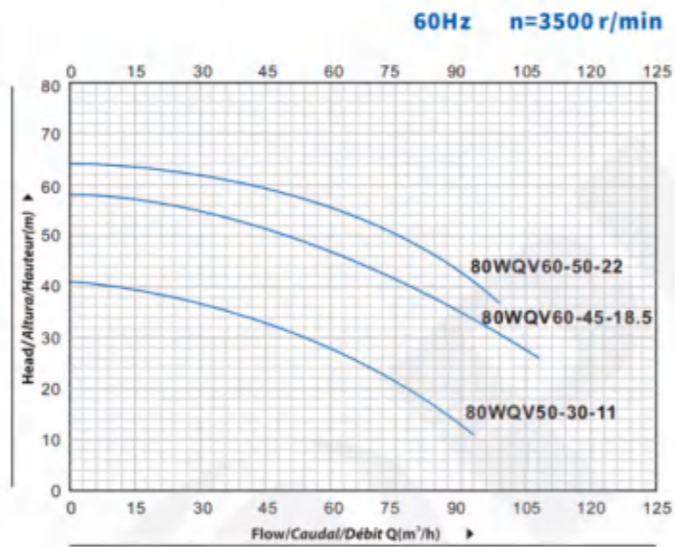
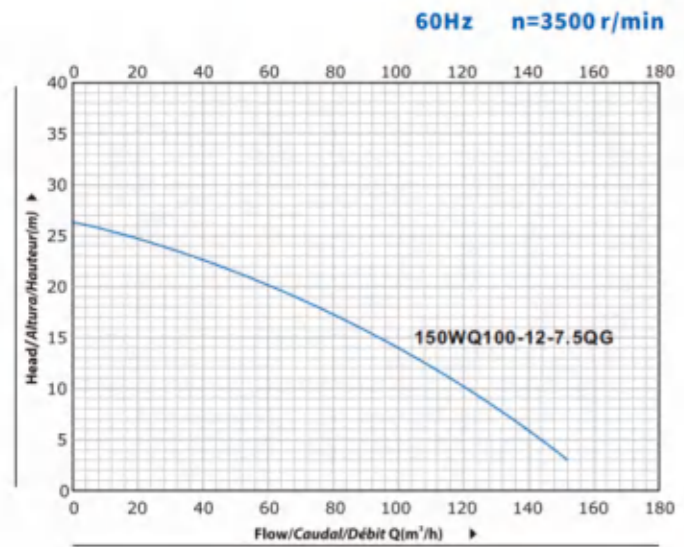
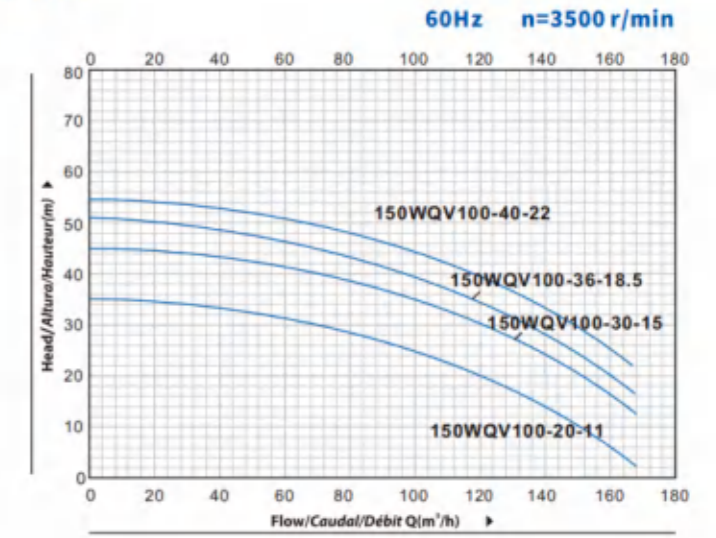
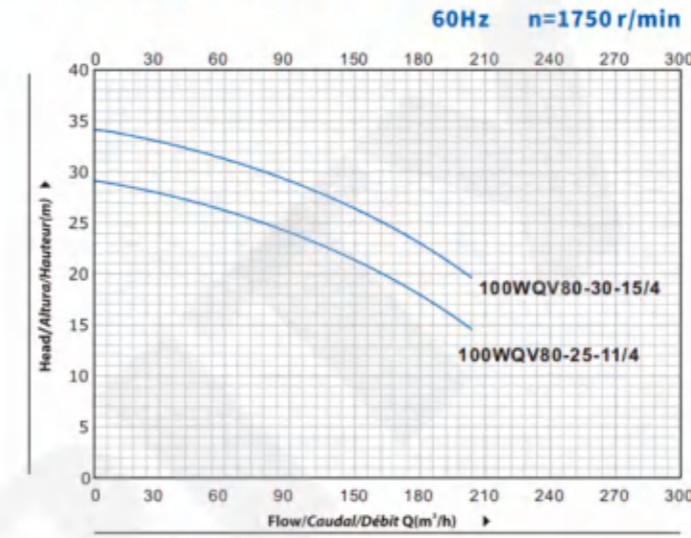

## MATERIAL DESCRIPTION/DESCRIPCIÓN DE MATERIAL/DESCRIPTION DU MATÉRIEL

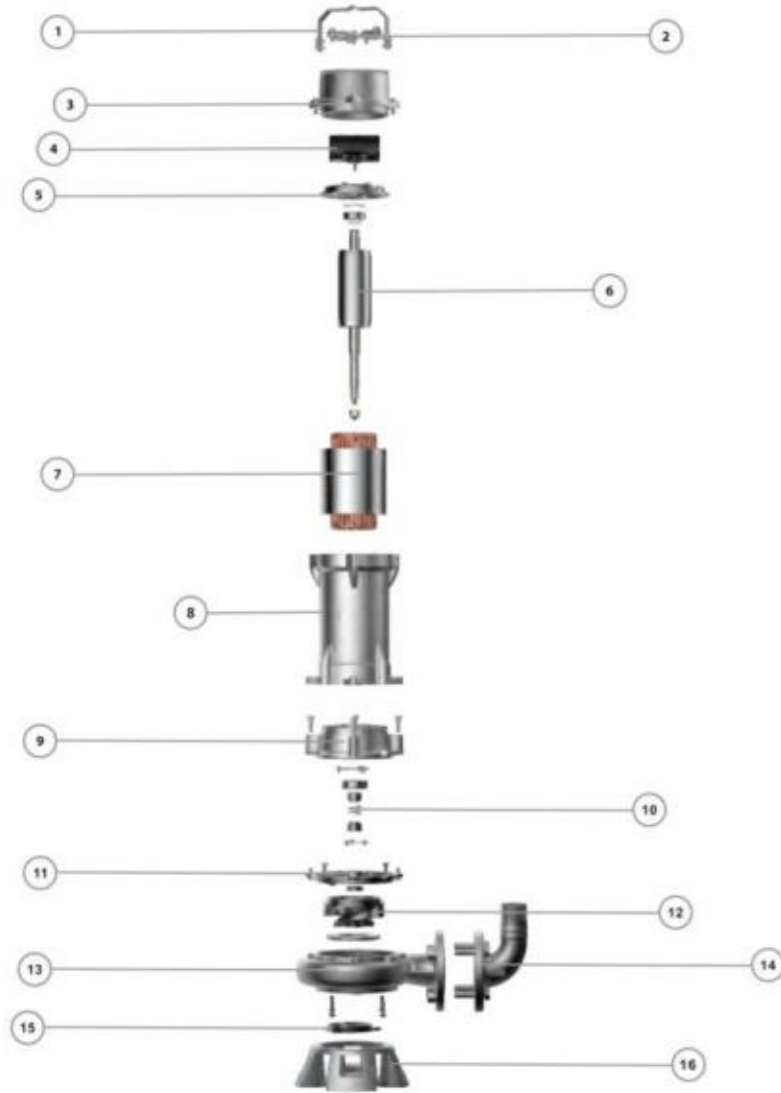

No.	Description Descripción Description	Material Material Matériel
1	Handle Mango Poignée	Q235 Q235 Q235
2	Press plate of cable Placa de presión del cable Plaque de pression de câble	Gray cast iron Hierro fundido gris Fonte grise
3	Top cover Cubierta superior Couverture supérieure	Gray cast iron Hierro fundido gris Fonte grise
4	electric capacity Capacidad eléctrica Capacité électrique	Ceramics cerámicos céramiques
5	Top bearing block Asiento superior del rodamiento Siège de roulement supérieur	Gray cast iron Hierro fundido gris Fonte grise
6	Rotor assembly Componentes del rotor Composants du rotor	Stainless steel welding Soldadura de acero inoxidable Soudure en acier inoxydable
7	stator assembly Componentes del estator Composants statoriques	Silicon Steel/Copper Acero al silicio / cobre Acier au silicium / cuivre
8	barrel Barril Seau	Gray cast iron Hierro fundido gris Fonte grise
9	hydrocylinder Fontgris Fontgris	Gray cast iron Hierro fundido gris Fonte grise
10	Mechanical seal Sello mecánico Joint mécanique	SiC/Carbon/SS304 Sic / carbono / ss304 SiC / carbone / ss304
11	Cylinder head Cabeza del cilindro Culasse de cylindre	Gray cast iron Hierro fundido gris Fonte grise
12	skeleton oil seal Sello de aceite de esqueleto Joint d'huile squelette	Stainless steel Acero inoxidable Acier inoxydable
13	pump body Cuerpo de la bomba Corps de pompe	Gray cast iron Hierro fundido gris Fonte grise
14	outlet elbow Codo de salida Coude de sortie	Ht200 Ht200 Ht200
15	Cutters Cortador Cutter	Stainless steel Acero inoxidable Acier inoxydable
16	base Base La base	Gray cast iron Hierro fundido gris Fonte grise





**WQ**

**Submersible sewage pump**  
**Bomba sumergible para aguas sucias**  
**Pompe submersible pour eaux usées**



**USING LIMITS/LÍMITES UTILIZACIÓN/UTILISATION LIMITES**

- ♦ Temperature of the liquid to +40 °C
  - ♦ 10m maximum immersion depth
  - ♦ Solids passage: from 25mm to 75mm
- ♦ Temperatura del líquido a +40 °C
  - ♦ 10m de profundidad de inmersión máxima
  - ♦ Paso de sólidos: de 25 mm a 75 mm
- ♦ Température du liquide à +40 °C
  - ♦ Profondeur d'immersion maximale de 10m
  - ♦ Passage des solides: de 25 mm à 75 mm

**NEW/NUEVO/NOUVEAU**  
**DESCRIPTION/DESCRIPCIONES/DESCRIPTION**

- ♦ Complete range with a full series submersible sewage pumps
  - ♦ Better hydraulic characteristics
  - ♦ Pump case in heavy gauge robust cast iron HT250
  - ♦ Casing resistant to abrasion and long-lasting
  - ♦ YE3 high efficient motor, with protection IP68 class F
  - ♦ Impeller in two vanes, non-clogging, close but big fluid channels
  - ♦ Discharge port with bolts, nuts and gaskets
- ♦ Gama completa con una serie completa de bombas para aguas residuales
  - ♦ Mejores características hidráulicas
  - ♦ Caja de bomba en hierro fundido robusto de gran calibre HT250
  - ♦ Carcasa resistente a la abrasión y duradera.
  - ♦ Motor de alta eficiencia YE3, con protección IP68 clase F
  - ♦ Impulsor en dos paletas, sin obstrucción, tipo de canales grande
  - ♦ Puerto de descarga con pernos, tuercas y empalmes
- ♦ Gamme complète avec une série complète de pompes pour eaux usées
  - ♦ Meilleures caractéristiques hydrauliques
  - ♦ Carter de pompe en fonte robuste de fort calibre HT250
  - ♦ Boîtier résistant à l'abrasion et durable
  - ♦ Moteur haute efficacité YE3, avec protection IP68 classe F
  - ♦ Roue à deux aubes, non obstruante, type à canaux étroits mais gros
  - ♦ Orifice de décharge avec boulons, écrous et joints

**APPLICATIONS/APLICACIONES/APPLICATIONS**

- ♦ Wastewater discharge in factories, shopping malls, hospitals, hotels
  - ♦ Residential area, parking lot, municipal sewage, rainwater drainage
  - ♦ Sewage discharge from sewage treatment plants and livestock farms
  - ♦ Pumping of mud and grey water in construction sites and mines
  - ♦ Clear water tank pumping for agriculture and aquaculture
  - ♦ Wastewater discharge from biogas digesters
  - ♦ Water supply and drainage in other occasions
- ♦ Descarga De Aguas Residuales En Fábricas, Centros Comerciales, Hospitales, Hoteles
  - ♦ Zona Residencial, Aparcamiento, Alcantarillado Municipal, Drenaje De Aguas Pluviales
  - ♦ Descarga De Aguas Residuales De Plantas De Tratamiento De Aguas Residuales Y Granjas Ganad.
  - ♦ Bombede Lodo Y Aguas Grises En Obras De Construcción Y Minas
  - ♦ Bombede Tanques De Agua Limpia Para Agricultura Y Acuicultura
  - ♦ Descarga De Aguas Residuales De Digestores De Biogás
  - ♦ Abastecimiento De Agua Y Drenaje En Otras Ocasiones
- ♦ le système de drainage de l'usine de traitement des eaux usées de la ville, l'hôpital, l'hôtel.
  - ♦ les usines, les émissions d'eaux usées du commerce gravement polluées. dispositif d'approvisionnement en eau de l'usine d'eau. Les stations de drainage des zones résidentielles.
  - ♦ station de drainage du système de défense humaine.
  - ♦ les travaux municipaux, le chantier du système d'approvisionnement en eau et de drainage.
  - ♦ les piscines de biogaz ruraux, l'irrigation agricole, l'étang de la rivière.
  - ♦ l'exploration, l'appui de l'exploitation minière.

**MODEL CODE/CÓDIGO MODELO/CODE MODÈLE**

For example/Par ejemplo/Par exemple

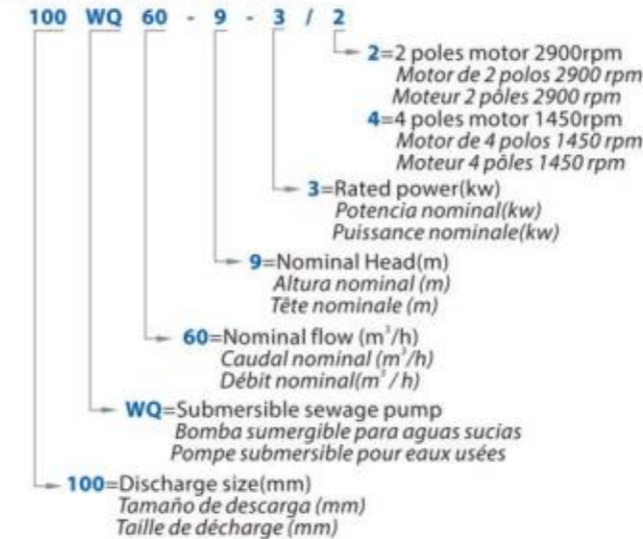

For example/Par ejemplo/Par exemple

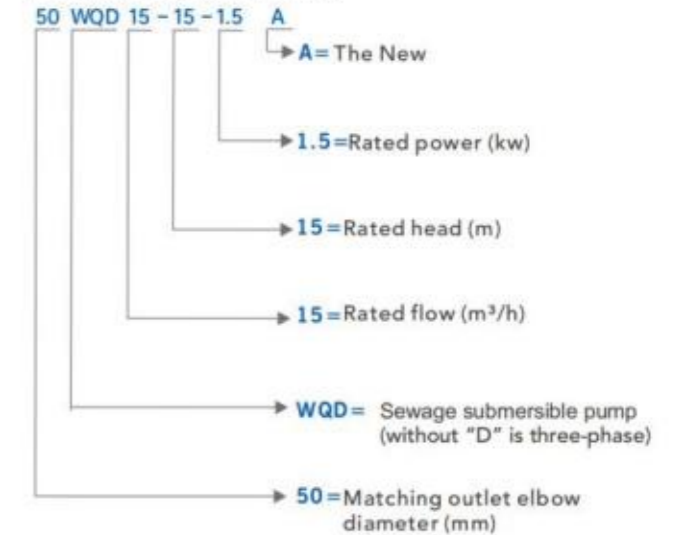



## PERFORMANCE CURVE/CURVA DE RENDIMIENTO/COURBE DE PERFORMANCE

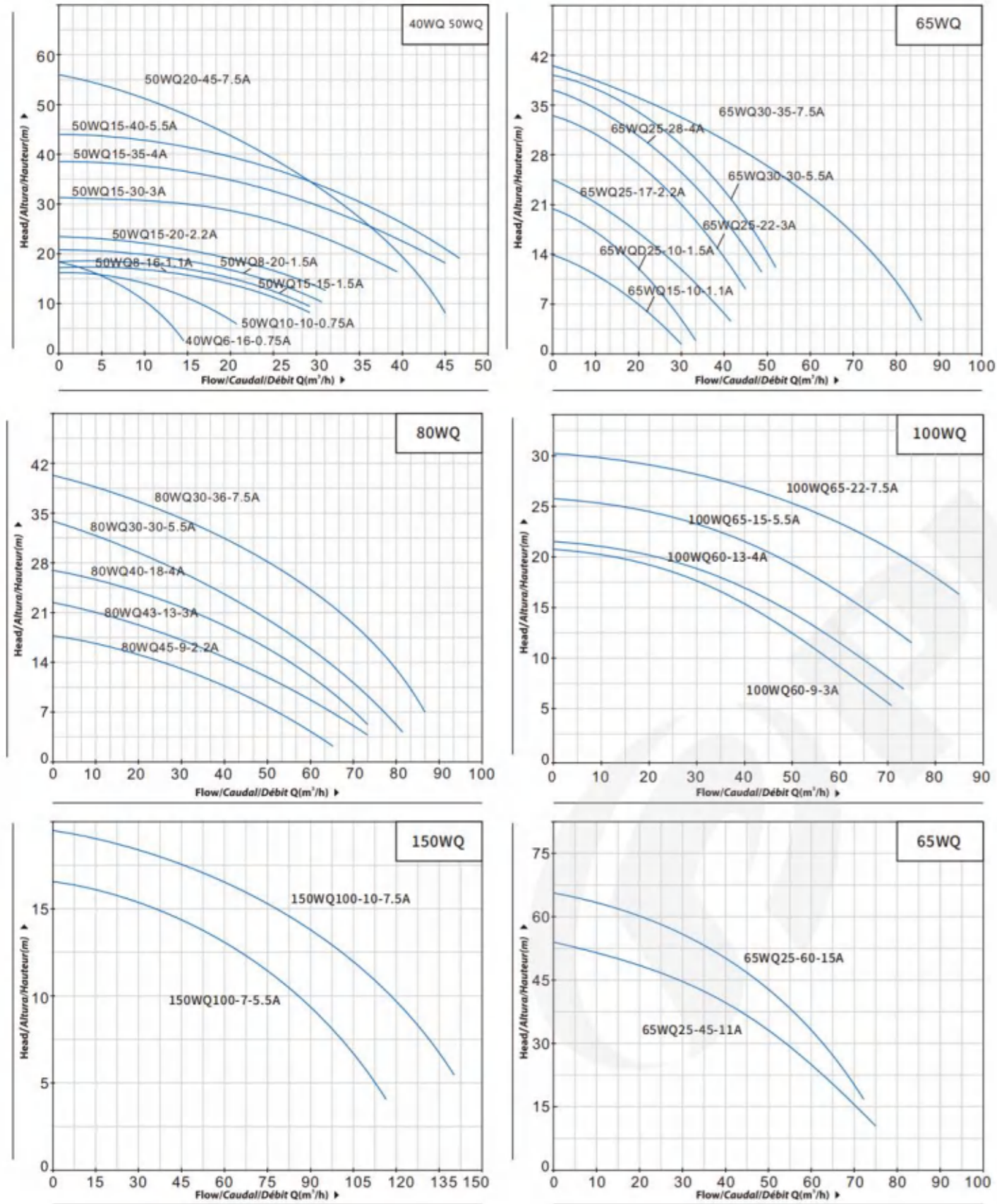

## PERFORMANCE CURVE/CURVA DE RENDIMIENTO/COURBE DE PERFORMANCE

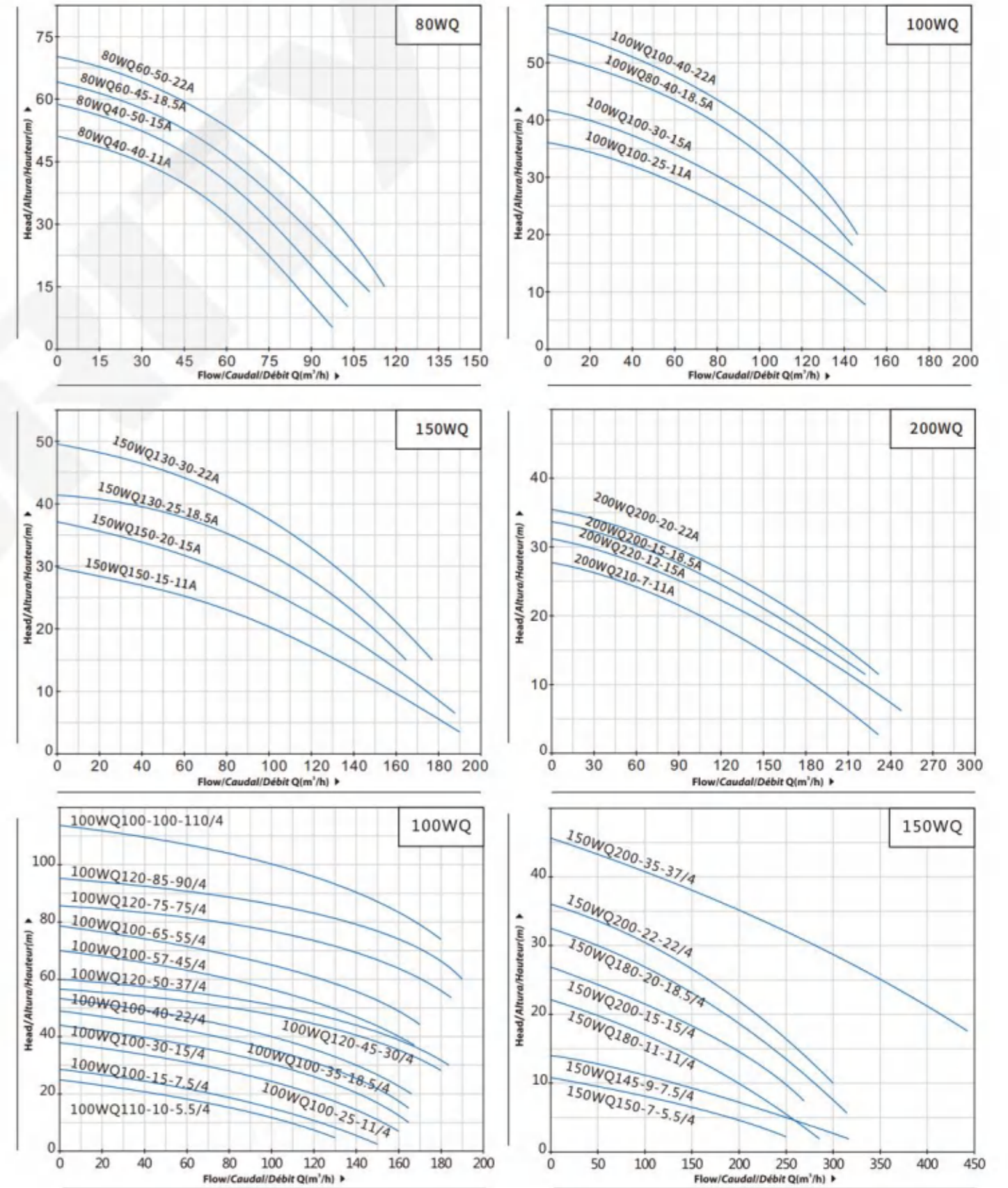

## PERFORMANCE CURVE/CURVA DE RENDIMIENTO/COURBE DE PERFORMANCE

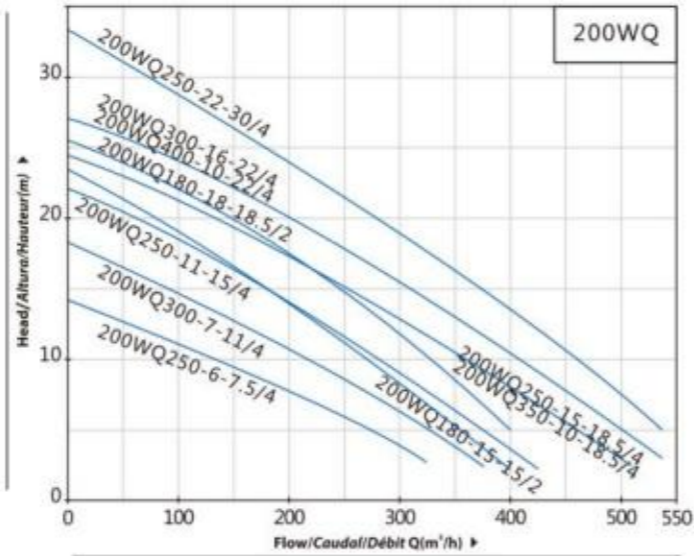
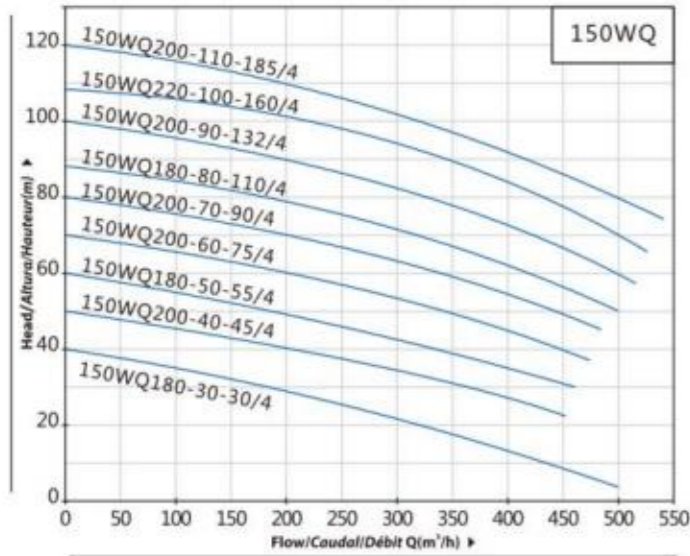

## PERFORMANCE CURVE/CURVA DE RENDIMIENTO/COURBE DE PERFORMANCE

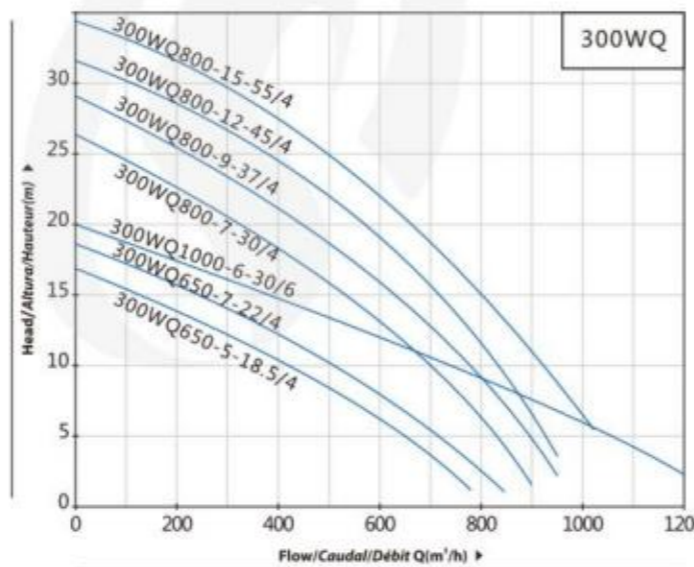
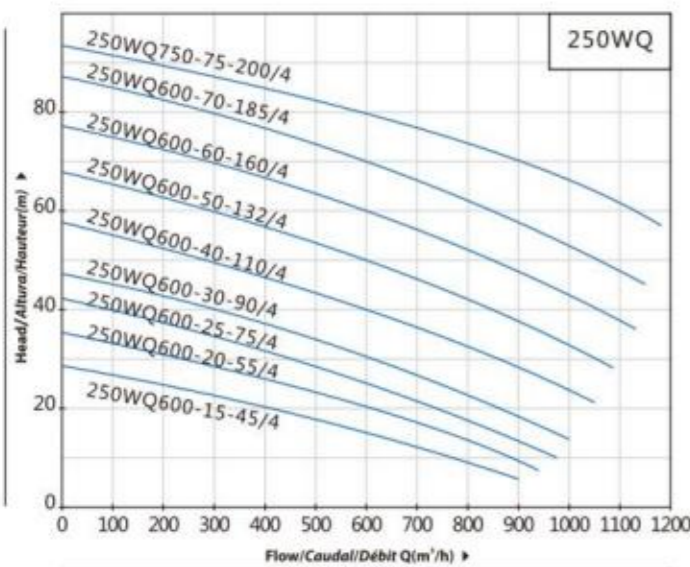
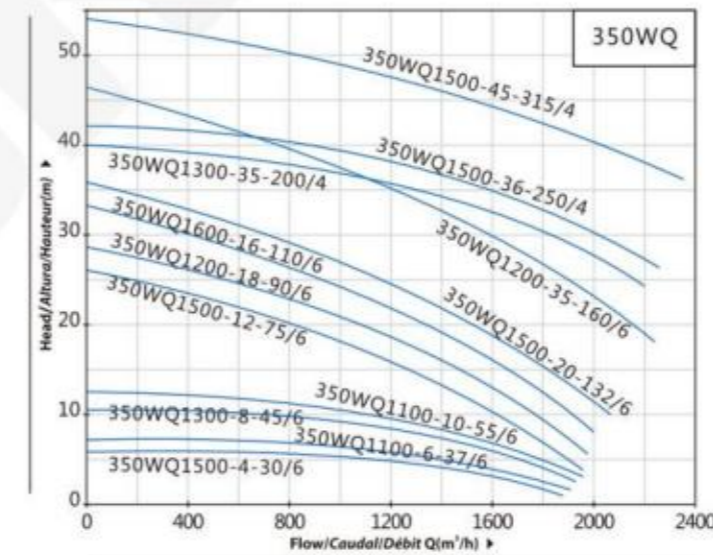
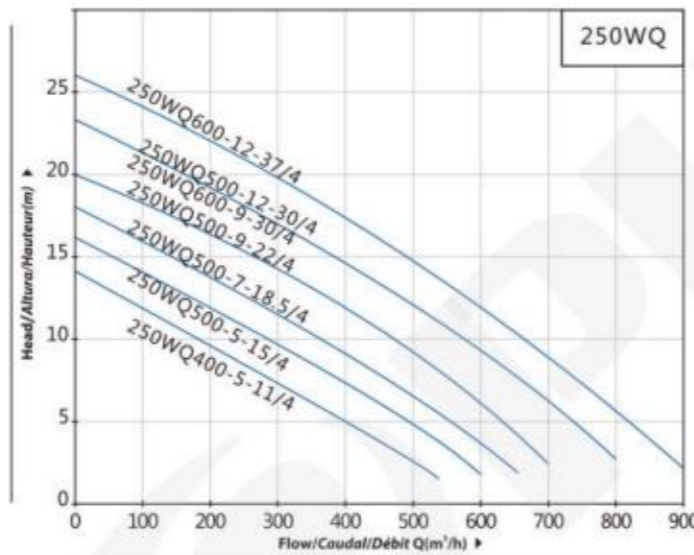
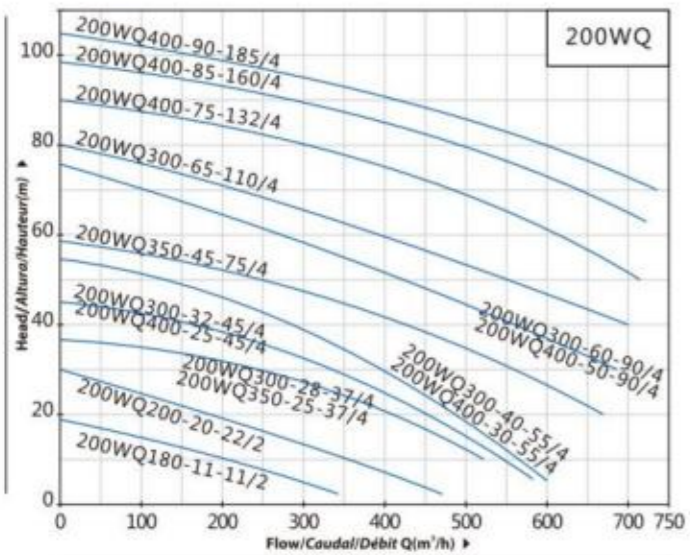
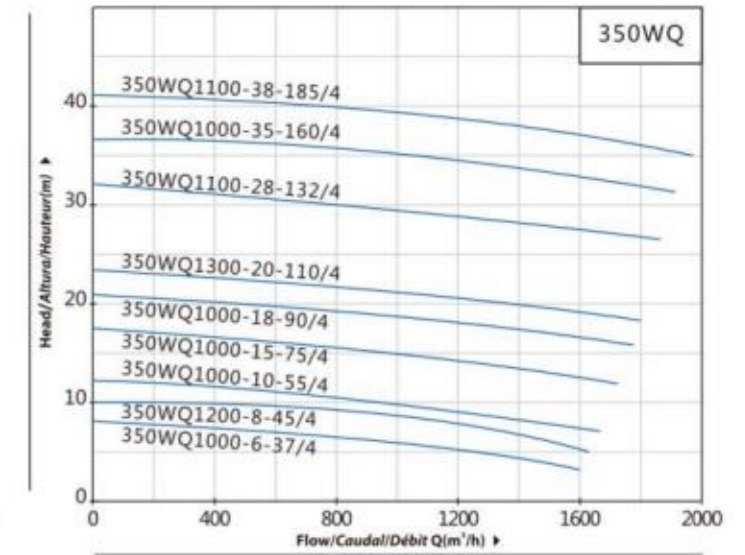
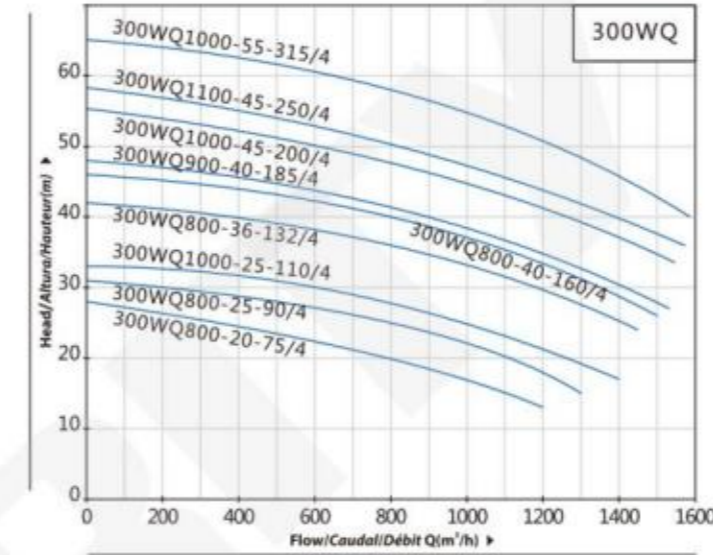

## MATERIAL DESCRIPTION/DESCRIPCIÓN DE MATERIAL/DESCRIPTION DU MATÉRIEL

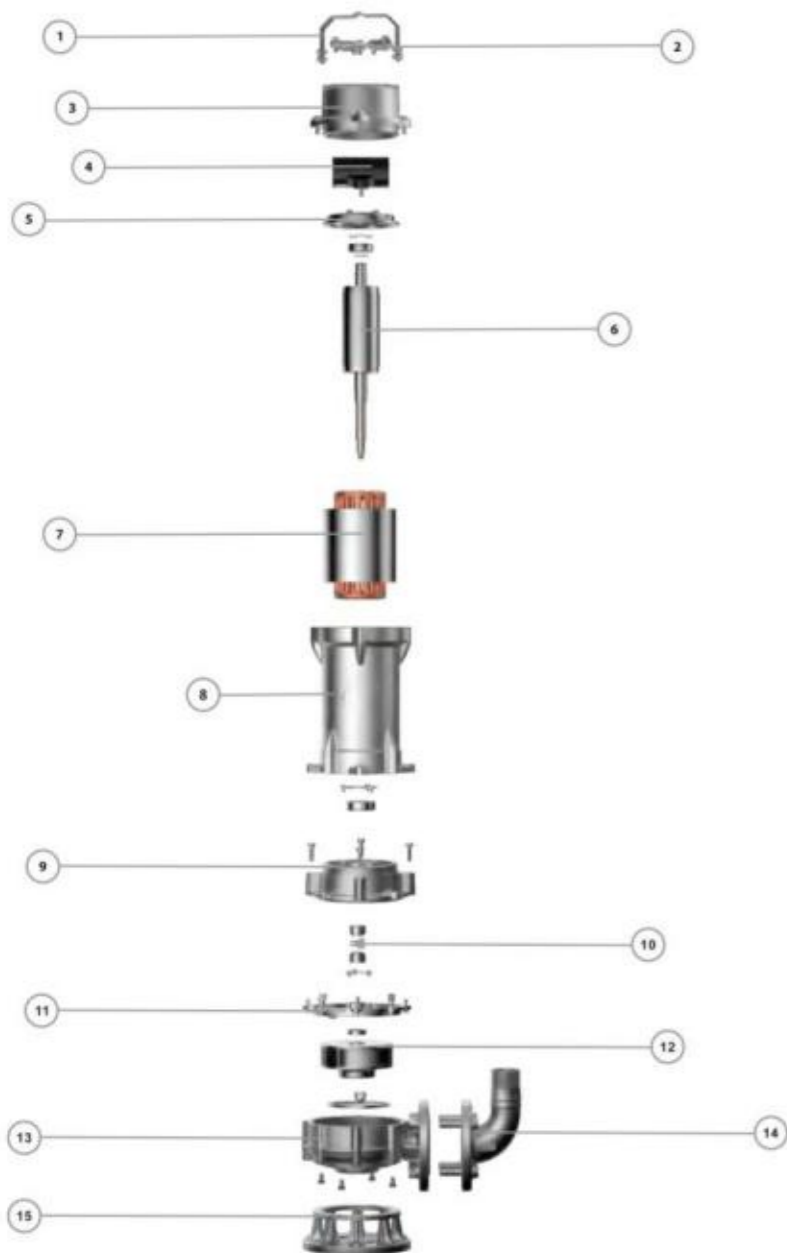

No.	Description Descripción Description	Material Material Matériel
1	Handle Mango Poignée	Q235 Q235 Q235
2	Press plate of cable Placa de presión del cable Plaque de pression de câble	Gray cast iron Hierro fundido gris Fonte grise
3	Top cover Cubierta superior Couverture supérieure	Gray cast iron Hierro fundido gris Fonte grise
4	electric capacity Capacidad eléctrica Capacité électrique	Ceramics cerámicas céramiques
5	Top bearing block Asiento superior del rodamiento Siège de roulement supérieur	Gray cast iron Hierro fundido gris Fonte grise
6	Rotor assembly Componentes del rotor Composants du rotor	Stainless steel welding Soldadura de acero inoxidable Soudure en acier inoxydable
7	stator assembly Componentes del estator Composants statoriques	Silicon Steel/Copper Acero al silicio / cobre Acier au silicium / cuivre
8	barrel Barril Seau	Gray cast iron Hierro fundido gris Fonte grise
9	hydrocylinder Fontgris Fontgris	Gray cast iron Hierro fundido gris Fonte grise
10	Mechanical seal Sello mecánico Joint mécanique	SiC/Carbon/SS304 SiC / carbono / ss304 SiC / carbone / ss304
11	Cylinder head Cabeza del cilindro Culasse de cylindre	Gray cast iron Hierro fundido gris Fonte grise
12	skeleton oil seal Sello de aceite de esqueleto Joint d'huile squelette	Stainless steel Acero inoxidable Acier inoxydable
13	pump body Cuerpo de la bomba Corps de pompe	Gray cast iron Hierro fundido gris Fonte grise
14	outlet elbow Codo de salida Coude de sortie	Ht200 Ht200 Ht200
15	base Base La base	Gray cast iron Hierro fundido gris Fonte grise

# WQ

## SUBMERSIBLE SEWAGE PUMP







**NEW/NUEVO/NOUVEAU**  
**DESCRIPTION/DESCRIPCIONES/DESCRIPTION**

- ◆ The turbine fire pump consists of three parts: the working portion, the water pipe portion, and the surface portion.
- ◆ The working part consists of working components and water filter components. The working components are composed of guide shell, impeller, conical sleeve, shell bearing, impeller shaft, and other components, and the impeller is a closed structure. The casing is connected with bolts. Wear rings can be installed on the guide shell and impeller.
- ◆ The water pipe part consists of water pipes, transmission shafts, couplings, and bracket components. The water pipes are connected by flanges, and the transmission shaft material is 2Cr13 or stainless steel.
- ◆ The surface components consist of pump base components, motors, motor brackets, couplings, and other components.

- ◆ La bomba de extinción de incendios de turbina consta de tres partes: la parte de trabajo, la parte de tubería de agua y la parte de superficie.
- ◆ La parte de trabajo consta de la parte de trabajo y la parte del filtro de agua. Los componentes de trabajo están compuestos por una carcasa guía, un impulsor, una manga cónica, un rodamiento de la carcasa, un eje del impulsor y otros componentes, y el impulsor es una estructura cerrada. La carcasa está atornillada. Los anillos resistentes al desgaste se pueden instalar en la carcasa guía y el impulsor.
- ◆ La parte de la tubería de agua consta de una tubería de agua, un eje de transmisión, un acoplamiento y componentes de soporte. La tubería de agua está conectada con brida, y el material del eje de transmisión es 2cr13 o acero inoxidable.
- ◆ Los componentes de superficie incluyen componentes de base de bomba, motores, soportes de motor, acoplamientos y otros componentes.

- ◆ Les explosions d'élimination de la combustion de la turbine persistent: côté Travail, côté tubería et côté surface.
- ◆ Le transporteur a toujours été le transporteur et le transporteur de marchandises. Les composants du travail comprennent les composants carcasa Guía, un impulsor, una manga cónica, un rodamiento de la carcasa, un Eje del impulsor et otros, et El impulsor es una Estructura Cerrada. Le motel. La résistance au vieillissement joue un rôle important dans les maladies cardiaques et les maladies cardiaques.
- ◆ Une partie du tubercule Agua a toujours été le tubercule agua, un processus de transport et une partie intégrante du transport et du transport. C'est un matériau non oxydable.
- ◆ Les composants de surface comprennent des composants de base de pompe, des composants de moteur, des composants de port de moteur, des composants de haut - parleur et d'autres composants.

**XBD**

Turbine Fire Pump

Bomba de incendio en una turbina

Pompe à incendie à turbine



**APPLICATIONS/APLICACIONES/APPLICATIONS**

- ◆ The turbine fire pumps are mainly used for fire hydrant fire extinguishing, automatic sprinkler fire extinguishing and other fire extinguishing systems in industrial and mining enterprises, engineering construction, and high-rise buildings as well as buildings, municipal water supply and drainage, etc.
- ◆ Las bombas de incendio de turbina se utilizan principalmente para la extinción de incendios por hidrante, extinción de incendios por aspersores automáticos y otros sistemas de extinción de incendios en empresas industriales y mineras, construcción de ingeniería y edificios de gran altura, así como edificios, suministro de agua municipal y drenaje, etc.
- ◆ Les pompes à incendie de turbine sont principalement utilisées pour l'extinction d'incendie de bouche d'incendie, l'extinction d'incendie automatique de gicleur et d'autres systèmes d'extinction d'incendie dans les entreprises industrielles et minières, la construction d'ingénierie, et les bâtiments de grande hauteur aussi bien que les bâtiments, l'approvisionnement en eau et le drainage municipaux, etc.

**USING LIMITS/LÍMITES UTILIZACIÓN/UTILISATION LIMITES**

- ◆ Generally non-corrosive clean water.
- ◆ The solid content in water (by weight) is not more than 0.01%.
- ◆ The PH value is within the range of 6.5-8.5.
- ◆ The hydrogen sulfide content is not more than 1.5 mg/L.
- ◆ The water temperature should not be higher than 40°C.
- ◆ Agua limpia generalmente no corrosiva.
- ◆ El contenido sólido en agua (en peso) no es superior al 0,01%.
- ◆ El valor de PH está dentro del rango de 6.5-8.5.
- ◆ El contenido de sulfuro de hidrógeno no es superior a 1,5 mg/L.
- ◆ La temperatura del agua no debe ser superior a 40°C.
- ◆ Eau propre généralement non corrosive.
- ◆ La teneur en solides dans l'eau (en poids) ne dépasse pas 0,01 %.
- ◆ La valeur du PH se situe entre 6,5 et 8,5.
- ◆ La teneur en sulfure d'hydrogène ne dépasse pas 1,5 mg/L.
- ◆ La température de l'eau ne doit pas dépasser 40°C.

**MODEL CODE/CÓDIGO MODELO/CODE MODÈLE**

For example/Par ejemplo/Par exemple

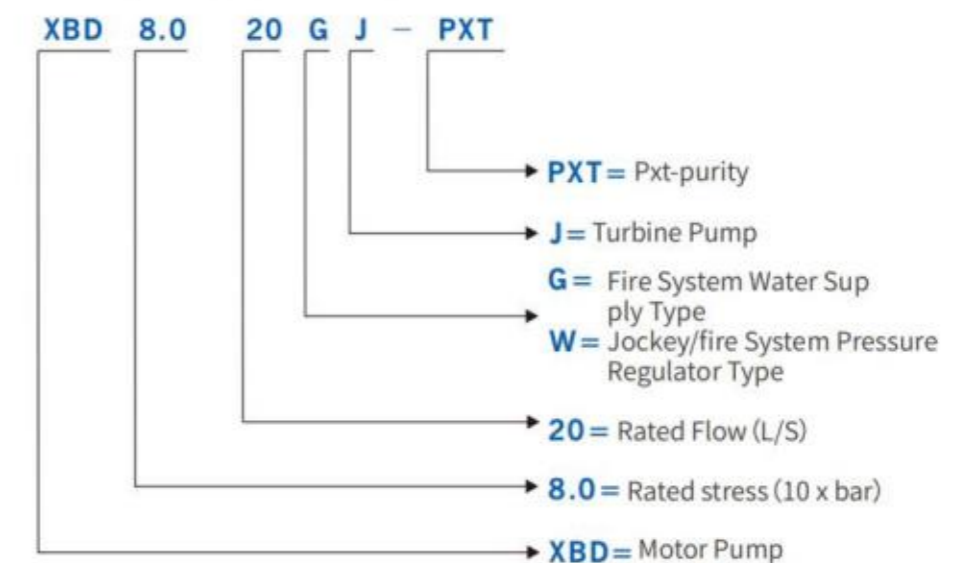

## TECHNICAL DATA/DATOS TÉCNICOS/DONNÉES TECHNIQUES

Model	Rated Flow (L/S)	Rated Head (m)	Rated Power (kW)	Synchronous Speed (r/min)	DN (mm)	Max. Pressure ( $\leq$ Mpa)	Pressure of 150% flow ( $\geq$ Mpa)
XBD4.0/1WJ-PXT	1	40	3	3500	50	0.560	0.260
XBD5.0/1WJ-PXT	1	50	4	3500	50	0.700	0.325
XBD6.0/1WJ-PXT	1	60	4	3500	50	0.840	0.390
XBD7.0/1WJ-PXT	1	70	5.5	3500	50	0.980	0.455
XBD8.0/1WJ-PXT	1	80	7.5	3500	50	1.120	0.520
XBD9.0/1WJ-PXT	1	90	7.5	3500	50	1.260	0.585
XBD10.0/1WJ-PXT	1	100	7.5	3500	50	1.400	0.650
XBD11.0/1WJ-PXT	1	110	11	3500	50	1.540	0.715
XBD12.0/1WJ-PXT	1	120	11	3500	50	1.680	0.780
XBD13.0/1WJ-PXT	1	130	11	3500	50	1.820	0.815
XBD14.0/1WJ-PXT	1	140	11	3500	50	1.960	0.910
XBD15.0/1WJ-PXT	1	150	15	3500	50	2.100	0.975
XBD16.0/1WJ-PXT	1	160	15	3500	50	2.240	1.040
XBD16.8.0/1WJ-PXT	1	168	15	3500	50	2.352	1.092
XBD4.0/3WJ-PXT	3	40	3	3500	50	0.560	0.260
XBD5.0/3WJ-PXT	3	50	4	3500	50	0.700	0.325
XBD6.0/3WJ-PXT	3	60	5.5	3500	50	0.840	0.390
XBD7.0/3WJ-PXT	3	70	7.5	3500	50	0.980	0.455
XBD8.0/3WJ-PXT	3	80	7.5	3500	50	1.120	0.520
XBD9.0/3WJ-PXT	3	90	7.5	3500	50	1.260	0.585
XBD10.0/3WJ-PXT	3	100	7.5	3500	50	1.400	0.650
XBD11.0/3WJ-PXT	3	110	11	3500	50	1.540	0.715
XBD12.0/3WJ-PXT	3	120	11	3500	50	1.680	0.780
XBD13.0/3WJ-PXT	3	130	11	3500	50	1.820	0.815
XBD14.0/3WJ-PXT	3	140	11	3500	50	1.960	0.90
XBD15.0/3WJ-PXT	3	150	15	3500	50	2.100	0.975
XBD16.0/3WJ-PXT	3	160	15	3500	50	2.240	1.040
XBD16.8/3WJ-PXT	3	168	15	3500	50	2.352	1.092
XBD4.0/5WJ-PXT	5	40	4	3500	50	0.560	0.260
XBD5.0/5WJ-PXT	5	50	5.5	3500	50	0.700	0.325
XBD6.0/5WJ-PXT	5	60	5.5	3500	50	0.840	0.390
XBD7.0/5WJ-PXT	5	70	7.5	3500	50	0.980	0.455
XBD8.0/5WJ-PXT	5	80	7.5	3500	50	1.120	0.520
XBD9.0/5WJ-PXT	5	90	11	3500	50	1.260	0.585
XBD10.0/5WJ-PXT	5	100	11	3500	50	1.400	0.650
XBD11.0/5WJ-PXT	5	110	11	3500	50	1.540	0.780
XBD12.0/5WJ-PXT	5	120	15	3500	50	1.680	0.845

## TECHNICAL DATA/DATOS TÉCNICOS/DONNÉES TECHNIQUES

Model	Rated Flow (L/S)	Rated Dust (m)	Rated Power (kW)	Synchronous Speed (r/min)	DN (mm)	Max. Pressure ( $\leq$ Mpa)	Pressure of 150% flow ( $\geq$ Mpa)
XBD13.0/5WJ-PXT	5	130	15	3500	50	1.820	0.845
XBD14.0/5WJ-PXT	5	140	15	3500	50	1.960	0.910
XBD15.0/5WJ-PXT	5	150	18.5	3500	50	2.100	0.975
XBD16.0/5WJ-PXT	5	160	18.5	3500	50	2.240	1.040
XBD16.8/5WJ-PXT	5	168	30	3500	50	2.352	1.092
XBD3.3/5GJ-PXT	5	33	3	3500	50	0.462	0.215
XBD4.0/5GJ-PXT	5	40	4	3500	50	0.560	0.260
XBD6.0/5GJ-PXT	5	60	5.5	3500	50	0.840	0.390
XBD8.0/5GJ-PXT	5	80	7.5	3500	50	1.120	0.520
XBD10.0/5GJ-PXT	5	100	11	3500	50	1.400	0.650
XBD12.0/5GJ-PXT	5	120	15	3500	50	1.680	0.780
XBD14.0/5GJ-PXT	5	140	15	3500	50	1.960	0.910
XBD16.3/5GJ-PXT	5	163	18.5	3500	50	2.282	1.060
XBD3.2/10GJ-PXT	10	32	5.5	3500	80	0.448	0.208
XBD4.2/10GJ-PXT	10	42	7.5	3500	80	0.588	0.273
XBD5.0/10GJ-PXT	10	50	11	3500	80	0.700	0.325
XBD6.0/10GJ-PXT	10	60	15	3500	80	0.840	0.390
XBD8.4/10GJ-PXT	10	84	15	3500	80	1.176	0.546
XBD9.6/10GJ-PXT	10	96	18.5	3500	80	1.344	0.624
XBD10.0/10GJ-PXT	10	100	18.5	3500	80	1.400	0.650
XBD11.0/10GJ-PXT	10	110	18.5	3500	80	1.540	0.715
XBD12.0/10GJ-PXT	10	120	22	3500	80	1.680	0.780
XBD13.0/10GJ-PXT	10	130	22	3500	80	1.820	0.845
XBD14.4/10GJ-PXT	10	144	30	3500	80	2.016	0.936
XBD15.6/10GJ-PXT	10	156	30	3500	80	2.184	1.014
XBD17.0/10GJ-PXT	10	170	37	3500	80	2.380	1.105
XBD18.0/10GJ-PXT	10	180	37	3500	80	2.520	1.170
XBD3.6/15GJ-PXT	15	36	11	3500	80	0.501	0.231
XBD4.0/15GJ-PXT	15	40	11	3500	80	0.560	0.260
XBD5.0/15GJ-PXT	15	50	15	3500	80	0.700	0.325
XBD6.0/15GJ-PXT	15	60	15	3500	80	0.840	0.390
XBD7.2/15GJ-PXT	15	72	18.5	3500	80	1.008	0.325
XBD8.4/15GJ-PXT	15	84	22	3500	80	1.176	0.468
XBD9.6/15GJ-PXT	15	96	22	3500	80	1.344	0.546
XBD10.0/15GJ-PXT	15	100	22	3500	80	1.400	0.624
XBD11.0/15GJ-PXT	15	110	30	3500	80	1540	0.650
XBD12.0/15GJ-PXT	15	120	30	3500	80	1680	0.715

## TECHNICAL DATA/DATOS TÉCNICOS/DONNÉES TECHNIQUES

Model	Rated Flow (L/S)	Rated Dust (m)	Rated Power (kW)	Synchronous Speed (r/min)	DN (mm)	Max. Pressure ( $\leq$ Mpa)	Pressure of 150% flow ( $\geq$ Mpa)
XBD13.0/15GJ-PXT	15	130	37	3500	80	1.820	0.845
XBD14.0/15GJ-PXT	15	140	37	3500	80	1.960	0.910
XBD15.6/15GJ-PXT	15	156	37	3500	80	2.184	1.014
XBD17.0/15GJ-PXT	15	170	45	3500	80	2.380	1.105
XBD18.2./15GJ-PXT	15	182	45	3500	80	2.518	1.183
XBD20.0/15GJ-PXT	15	200	55	3500	80	2.800	1.300
XBD3.3/20GJ-PXT	20	33	11	3500	100	0.462	0.215
XBD4.0/20GJ-PXT	20	40	15	3500	100	0.580	0.260
XBD4.4/20GJ-PXT	20	44	15	3500	100	0.616	0.286
XBD5.0/20GJ-PXT	20	50	18.5	3500	100	0.700	0.325
XBD5.5/20GJ-PXT	20	55	18.5	3500	100	0.770	0.358
XBD6.0/20GJ-PXT	20	60	22	3500	100	0.700	0.325
XBD6.6/20GJ-PXT	20	66	22	3500	100	0.924	0.429
XBD7.0/20GJ-PXT	20	70	30	3500	100	0.980	0.455
XBD8.0/20GJ-PXT	20	80	30	3500	100	1.120	0.520
XBD9.0/20GJ-PXT	20	90	30	3500	100	1.260	0.585
XBD10.0/20GJ-PXT	20	100	37	3500	100	1.400	0.650
XBD11.0/20GJ-PXT	20	110	37	3500	100	1.540	0.75
XBD12.1/20GJ-PXT	20	121	45	3500	100	1.694	0.787
XBD14.0/20GJ-PXT	20	140	45	3500	100	1.960	0.910
XBD16.0/20GJ-PXT	20	160	55	3500	100	2.240	1.040
XBD18.0/20GJ-PXT	20	180	55	3500	100	2.520	1.170
XBD20.0/20GJ-PXT	20	200	75	3500	100	2.800	1.300
XBD3.2/25GJ-PXT	25	32	11	3500	100	0.448	0.208
XBD4.2/25GJ-PXT	25	42	15	3500	100	0.588	0.273
XBD5.3/25GJ-PXT	25	53	18.5	3500	100	0.742	0.345
XBD6.3/25GJ-PXT	25	63	22	3500	100	0.882	0.410
XBD7.3/25GJ-PXT	25	73	30	3500	100	1.022	0.475
XBD8.4/25GJ-PXT	25	84	37	3500	100	1.176	0.546
XBD9.0/25GJ-PXT	25	90	37	3500	100	1.260	0.585
XBD10.0/25GJ-PXT	25	100	37	3500	100	1.400	0.950
XBD11.0/25GJ-PXT	25	110	45	3500	100	1.540	0.715
XBD12.0/25GJ-PXT	25	120	45	3500	100	1.680	0.780
XBD14.0/25GJ-PXT	25	140	55	3500	100	1.960	0.910
XBD16.0/25GJ-PXT	25	160	75	3500	100	2.240	1.040
XBD18.5/25GJ-PXT	25	185	75	3500	100	2.590	1.203
XBD3.6/30GJ-PXT	30	36	15	3500	100	0.504	0.234

## TECHNICAL DATA/DATOS TÉCNICOS/DONNÉES TECHNIQUES

Model	Rated Flow (L/S)	Rated Dust (m)	Rated Power (kW)	Synchronous Speed (r/min)	DN (mm)	Max. Pressure ( $\leq$ Mpa)	Pressure of 150% flow ( $\geq$ Mpa)
XBD4.2/30GJ-PXT	30	40	18.5	3500	100	0.560	0.260
XBD5.0/30GJ-PXT	30	50	22	3500	100	0.700	0.325
XBD6.0/30GJ-PXT	30	60	30	3500	100	0.840	0.390
XBD7.2/30GJ-PXT	30	72	30	3500	100	1.008	0.468
XBD8.0/30GJ-PXT	30	80	37	3500	100	1.120	0.520
XBD9.0/30GJ-PXT	30	90	45	3500	100	1.260	0.585
XBD10.0/30GJ-PXT	30	100	45	3500	100	1.400	0.650
XBD11.0/30GJ-PXT	30	110	45	3500	100	1.540	0.715
XBD13.0/30GJ-PXT	30	130	55	3500	100	1.820	0.845
XBD14.5/30GJ-PXT	30	145	75	3500	100	2.030	0.943
XBD16.2/30GJ-PXT	30	162	75	3500	100	2.268	1.053
XBD18.0/30GJ-PXT	30	180	90	3500	100	2.520	1.170
XBD20.0/30GJ-PXT	30	200	90	3500	100	2.800	1.300
XBD3.2/35GJ-PXT	35	32	18.5	3500	100	0.448	0.208
XBD4.0/35GJ-PXT	35	40	22	3500	100	0.560	0.260
XBD5.0/35GJ-PXT	35	50	30	3500	100	0.700	0.325
XBD6.0/35GJ-PXT	35	60	30	3500	100	0.840	0.390
XBD6.5/35GJ-PXT	35	65	37	3500	100	0.910	0.423
XBD7.0/35GJ-PXT	35	70	37	3500	100	0.980	0.455
XBD8.0/35GJ-PXT	35	80	45	3500	100	1.120	0.520
XBD9.0/35GJ-PXT	35	90	55	3500	100	1.260	0.585
XBD10.0/35GJ-PXT	35	100	55	3500	100	1.400	0.650
XBD11.2/35GJ-PXT	35	112	75	3500	100	1.568	0.728
XBD13.0/35GJ-PXT	35	130	75	3500	100	1.820	0.845
XBD15.0/35GJ-PXT	35	150	90	3500	100	2.100	0.975
XBD16.0/35GJ-PXT	35	160	90	3500	100	2.240	1.040
XBD18.0/35GJ-PXT	35	180	110	3500	100	2.520	1.170
XBD19.2/35GJ-PXT	35	192	110	3500	100	2.688	1.248
XBD20.0/35GJ-PXT	35	200	132	3500	100	2.800	1.300
XBD3.2/40GJ-PXT	40	32	18.5	3500	150	0.448	0.208
XBD4.0/40GJ-PXT	40	40	22	3500	150	0.560	0.260
XBD4.8/40GJ-PXT	40	48	30	3500	150	0.672	0.312
XBD5.0/40GJ-PXT	40	50	30	3500	150	0.700	0.325
XBD6.0/40GJ-PXT	40	60	37	3500	150	0.840	0.390
XBD7.0/40GJ-PXT	40	70	45	3500	150	0.980	0.455
XBD8.0/40GJ-PXT	40	80	45	3500	150	1.120	0.520
XBD9.0/40GJ-PXT	40	90	55	3500	150	1.260	0.585

## TECHNICAL DATA/DATOS TÉCNICOS/DONNÉES TECHNIQUES

Model	Rated Flow (L/S)	Rated Dust (m)	Rated Power (kW)	Synchronous Speed (r/min)	DN (mm)	Max. Pressure (≤Mpa)	Pressure of 150% flow (≥Mpa)
XBD10.0/40GJ-PXT	40	100	55	3500	150	1.400	0.650
XBD11.0/40GJ-PXT	40	110	75	3500	150	1.540	0.715
XBD12.0/40GJ-PXT	40	120	75	3500	150	1.680	0.780
XBD14.0/40GJ-PXT	40	140	90	3500	150	1.960	0.910
XBD15.0/40GJ-PXT	40	150	90	3500	150	2.100	0.975
XBD16.5/40GJ-PXT	40	165	110	3500	150	2.310	1.073
XBD18.5/40GJ-PXT	40	180	110	3500	150	2.520	1.170
XBD20.0/40GJ-PXT	40	200	132	3500	150	2.800	1.300
XBD3.0/45GJ-PXT	45	30	22	3500	150	0.420	0.195
XBD4.0/45GJ-PXT	45	40	30	3500	150	0.560	0.260
XBD5.0/45GJ-PXT	45	50	37	3500	150	0.700	0.325
XBD6.0/45GJ-PXT	45	60	45	3500	150	0.810	0.390
XBD7.0/45GJ-PXT	45	70	55	3500	150	0.980	0.455
XBD8.0/45GJ-PXT	45	80	55	3500	150	1.120	0.520
XBD9.0/45GJ-PXT	45	90	75	3500	150	1.260	0.585
XBD10.0/45GJ-PXT	45	100	75	3500	150	1.400	0.650
XBD3.2/50GJ-PXT	50	32	22	3500	150	0.448	0.208
XBD4.0/50GJ-PXT	50	40	30	3500	150	0.560	0.260
XBD4.5/50GJ-PXT	50	45	37	3500	150	0.630	0.293
XBD5.0/50GJ-PXT	50	50	37	3500	150	0.700	0.325
XBD6.0/50GJ-PXT	50	60	45	3500	150	0.840	0.390
XBD7.0/50GJ-PXT	50	70	55	3500	150	0.980	0.455
XBD8.0/50GJ-PXT	50	80	55	3500	150	1.120	0.520
XBD9.0/50GJ-PXT	50	90	75	3500	150	1.260	0.585
XBD10.5/50GJ-PXT	50	105	75	3500	150	1.470	0.683
XBD12.0/50GJ-PXT	50	120	90	3500	150	1.680	0.780
XBD14.0/50GJ-PXT	50	140	110	3500	150	1.960	0.910
XBD15.0/50GJ-PXT	50	150	132	3500	150	2.100	0.975
XBD17.0/50GJ-PXT	50	170	160	3500	150	2.380	1.105
XBD18.0/50GJ-PXT	50	180	160	3500	150	2.520	1.170
XBD20.0/50GJ-PXT	50	200	200	3500	150	2.800	1.300
XBD4.0/55GJ-PXT	55	40	37	3500	150	0.560	0.260
XBD5.0/55GJ-PXT	55	50	45	3500	150	0.700	0.325
XBD6.0/55GJ-PXT	55	60	55	3500	150	0.840	0.390
XBD7.0/55GJ-PXT	55	70	55	3500	150	0.980	0.455
XBD8.0/55GJ-PXT	55	80	75	3500	150	1.120	0.520
XBD10.0/55GJ-PXT	55	100	90	3500	150	1.400	0.650

## TECHNICAL DATA/DATOS TÉCNICOS/DONNÉES TECHNIQUES

Model	Rated Flow (L/S)	Rated Dust (m)	Rated Power (kW)	Synchronous Speed (r/min)	DN (mm)	Max. Pressure (≤Mpa)	Pressure of 150% flow (≥Mpa)
XBD4.0/60GJ-PXT	60	40	37	3500	150	0.560	0.260
XBD5.0/60GJ-PXT	60	50	45	3500	150	0.700	0.325
XBD6.0/60GJ-PXT	60	60	55	3500	150	0.840	0.390
XBD7.0/60GJ-PXT	60	70	75	3500	150	0.980	0.455
XBD8.0/60GJ-PXT	60	80	75	3500	150	1.120	0.520
XBD9.0/60GJ-PXT	60	90	90	3500	150	1.260	0.585
XBD10.0/60GJ-PXT	60	100	90	3500	150	1.400	0.650
XBD12.0/60GJ-PXT	60	120	110	3500	150	1.680	0.780
XBD14.0/60GJ-PXT	60	140	132	3500	150	1.960	0.910
XBD16.0/60GJ-PXT	60	160	160	3500	150	2.240	1.040
XBD18.0/60GJ-PXT	60	180	160	3500	150	2.520	1.170
XBD20.0/60GJ-PXT	60	200	200	3500	150	2.800	1.300
XBD3.0/70GJ-PXT	70	30	37	3500	150	0.420	0.195
XBD4.0/70GJ-PXT	70	40	45	3500	150	0.560	0.260
XBD5.0/70GJ-PXT	70	50	55	3500	150	0.700	0.325
XBD6.0/70GJ-PXT	70	60	75	3500	150	0.840	0.390
XBD7.2/70GJ-PXT	70	72	90	3500	150	1.008	0.468
XBD8.2/70GJ-PXT	70	82	110	3500	150	1.148	0.533
XBD9.0/70GJ-PXT	70	90	110	3500	150	1.260	0.585
XBD10.0/70GJ-PXT	70	100	132	3500	150	1.400	0.650
XBD13.0/70GJ-PXT	70	130	160	3500	150	1.820	0.845
XBD15.0/70GJ-PXT	70	150	200	3500	150	2.100	0.975
XBD3.0/80GJ-PXT	80	30	37	3500	150	0.420	0.195
XBD4.0/80GJ-PXT	80	40	45	3500	150	0.560	0.260
XBD5.0/80GJ-PXT	80	50	55	3500	150	0.700	0.325
XBD6.0/80GJ-PXT	80	60	75	3500	150	0.840	0.390
XBD7.2/80GJ-PXT	80	72	90	3500	150	1.008	0.468
XBD8.2/80GJ-PXT	80	82	110	3500	150	1.148	0.533
XBD9.0/80GJ-PXT	80	90	110	3500	150	1.260	0.585
XBD10.0/80GJ-PXT	80	100	132	3500	150	1.400	0.650
XBD13.0/80GJ-PXT	80	130	160	3500	150	1.820	0.845
XBD15.0/80GJ-PXT	80	150	200	3500	150	2.100	0.975
XBD3.0/90GJ-PXT	90	30	55	3500	200	0.420	0.195
XBD4.0/90GJ-PXT	90	40	75	3500	200	0.560	0.260
XBD5.0/90GJ-PXT	90	50	75	3500	200	0.700	0.325
XBD6.0/90GJ-PXT	90	60	90	3500	200	0.840	0.390
XBD7.0/90GJ-PXT	90	70	110	3500	200	0.980	0.455

**TECHNICAL DATA/DATOS TÉCNICOS/DONNÉES TECHNIQUES**

Model	Rated Flow (L/S)	Rated Dust (m)	Rated Power (kW)	Synchronous Speed (r/min)	DN (mm)	Max. Pressure (≤Mpa)	Pressure of 150% flow (≥Mpa)
XBD8.0/90GJ-PXT	90	80	110	3500	200	1.120	0.520
XBD9.0/90GJ-PXT	90	90	132	3500	200	1.260	0.585
XBD10.2/90GJ-PXT	90	102	160	3500	200	1.428	0.663
XBD12.0/90GJ-PXT	90	120	200	3500	200	1.680	0.780
XBD3.0/100GJ-PXT	100	30	55	3500	200	0.420	0.195
XBD4.0/100GJ-PXT	100	40	75	3500	200	0.560	0.280
XBD5.0/100GJ-PXT	100	50	75	3500	200	0.700	0.325
XBD6.0/100GJ-PXT	100	60	90	3500	200	0.840	0.390
XBD7.0/100GJ-PXT	100	70	110	3500	200	0.980	0.455
XBD8.0/100GJ-PXT	100	80	132	3500	200	1.120	0.520
XBD9.0/100GJ-PXT	100	90	160	3500	200	1.260	0.585
XBD9.8/100GJ-PXT	100	98	200	3500	200	1.372	0.637
XBD3.0/110GJ-PXT	100	30	55	3500	200	0.420	0.195
XBD4.0/110GJ-PXT	110	40	75	3500	200	0.560	0.260
XBD5.0/110GJ-PXT	110	50	90	3500	200	0.700	0.325
XBD6.0/110GJ-PXT	110	60	110	3500	200	0.840	0.390
XBD7.0/110GJ-PXT	110	70	132	3500	200	0.980	0.455
XBD8.0/110GJ-PXT	110	80	160	3500	200	1.120	0.520
XBD9.0/110GJ-PXT	110	90	160	3500	200	1.260	0.585
XBD10.0/110GJ-PXT	110	100	200	3500	200	1.400	0.650

**CONSTRUCTION/Estructura/Construction**

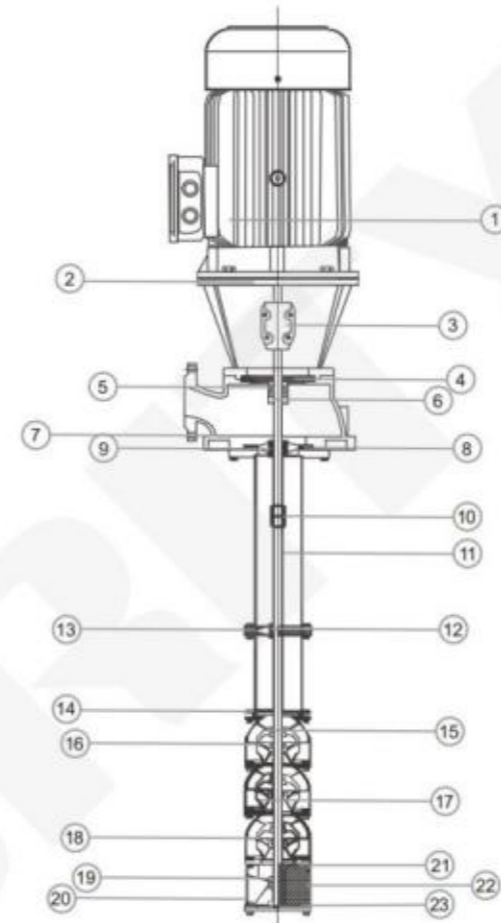

NO.	ITEM	MATERIAL
1	Motor	SUBASSEMBLY
2	Motor Support	QT400-18
3	Coupling	ZG235-150
4	Seal Cover	QT100-18
5	Mechanical Seal	CARBON-SIC-NBR
6	Seal Holder	ZG235-450
7	Outelet	QT400-18
8	Pump Bracket	QT400-18
9	Support Shaft	COTTON IRON
10	Coupling	ZG235-150
11	Shaft	20CR13
12	Support Bearing	COTTON IRON
13	Bracket	QT100-18
14	Top Bowl	QT 100-18
15	Bearing-bowl	RUBBER
16	Dish Bowl	20CR13
17	Impeller	06CR19NI10
18	Middle Bowl	QT400-18
19	Bearing	RUBBER
20	Suction Bell	QT100-18
21	Filter	06CR19NI10
22	Thrust Disc	20CR13
23	Forward Thrust Plate	A MIXTURE OF TEFLON

**INSTALLATION DIMENSIONS/Tamaño de la instalación/Dimensions de l'installation**

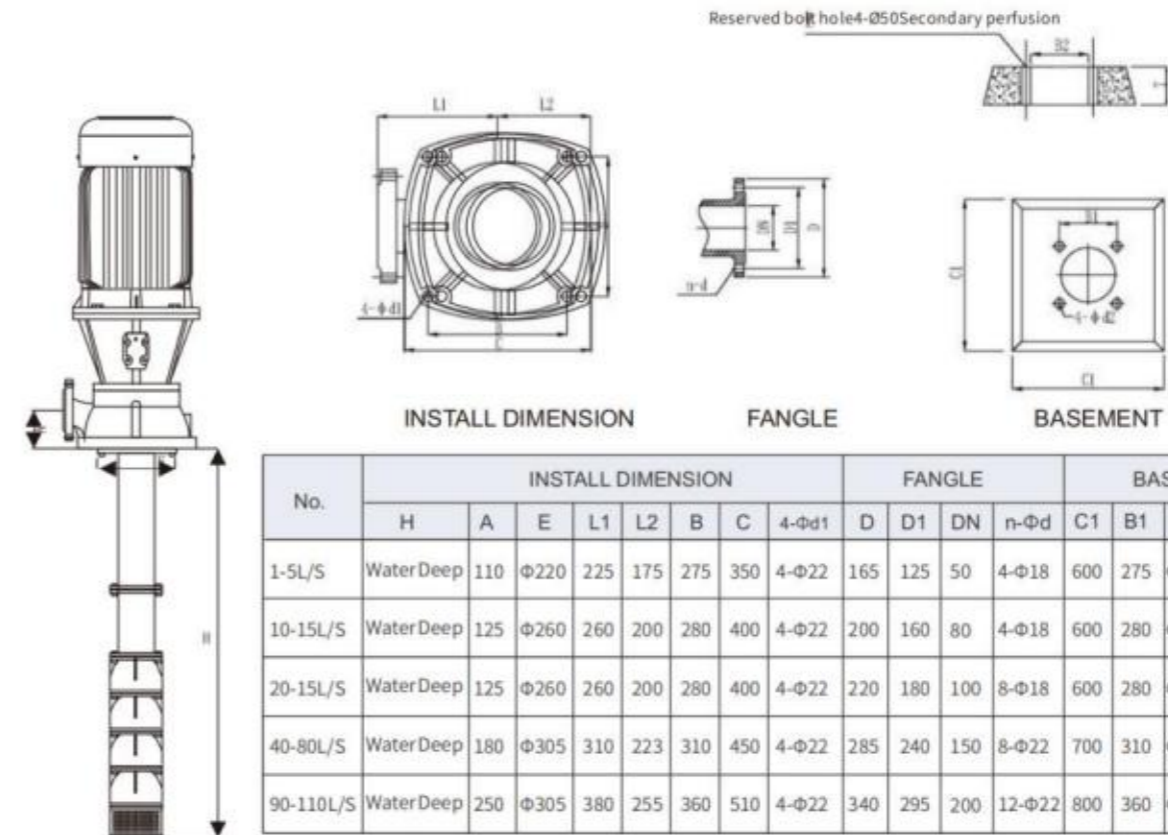

No.	INSTALL DIMENSION							FANGLE				BASEMENT					
	H	A	E	L1	L2	B	C	4-Φd1	D	D1	DN	n-Φd	C1	B1	B2	T	4-Φd2
1-5L/S	Water Deep	110	Φ220	225	175	275	350	4-Φ22	165	125	50	4-Φ18	600	275	Φ280	300	4-Φ50
10-15L/S	Water Deep	125	Φ260	260	200	280	400	4-Φ22	200	160	80	4-Φ18	600	280	Φ280	300	4-Φ50
20-15L/S	Water Deep	125	Φ260	260	200	280	400	4-Φ22	220	180	100	8-Φ18	600	280	Φ280	300	4-Φ50
40-80L/S	Water Deep	180	Φ305	310	223	310	450	4-Φ22	285	240	150	8-Φ22	700	310	Φ310	300	4-Φ50
90-110L/S	Water Deep	250	Φ305	380	255	360	510	4-Φ22	340	295	200	12-Φ22	800	360	Φ330	300	4-Φ50



## PBWS

Non-negative pressure water supply system  
 Sistema de suministro de agua presión no negativa  
 Système d'alimentation en eau à pression non négative



### NEW/NUEVO/NOUVEAU

#### DESCRIPTION/DESCRIPCIONES/DESCRIPTION

- A brand-new water supply system
  - Equipped with a water tank of a certain volume
  - Tank made of the stainless steel in food class.
  - Equipped with a water supply quality pump unit
  - The water supply pump unit is independent from the water tank, easy to be maintained and cleaned.
  - Equipped with a negative pressure preventing module
  - Equipped with a multi-function control panel
- Un nuevo sistema de suministro de agua.
  - Equipado con un tanque de agua de un cierto volumen.
  - Tanque hecho del acero inoxidable en la clase de alimentos.
  - Equipado con una unidad bombeo de calidad de suministro de agua.
  - La unidad de bombeo de suministro de agua es independiente de la depósito de agua, fácil de mantener y limpiar.
  - Equipado con un módulo de prevención de presión negativa.
  - Equipado con un panel de control multifunción
- Un tout nouveau système d'alimentation en eau
  - Equipé d'un réservoir d'eau d'un certain volume
  - Réservoir en acier inoxydable dans la classe alimentaire.
  - Equipé d'une pompe de qualité d'alimentation en eau
  - La pompe d'alimentation en eau est indépendante de l'eau réservoir, facile à entretenir et à nettoyer.
  - Equipé d'un module empêchant la pression négative
  - Equipé d'un panneau de commande multifonction

#### APPLICATIONS/APLICACIONES/APPLICATIONS

- The PBWS series are suitable for those areas with relatively unstable municipal pipe network, long water used peak time and a very strict requirement on the noise, such as hospital, school etc
- La serie PBWS es adecuada para aquellas áreas con redes de tuberías municipales relativamente inestables, horas pico de uso de agua prolongado y un requisito muy estricto sobre el ruido, como hospitales, escuelas, etcétera
- La série PBWS convient aux zones à instabilité relative réseau de canalisations municipales, eau longue utilisée aux heures de pointe et exigence très stricte sur le bruit, comme l'hôpital, l'école, etc.

#### USING LIMITS/LÍMITES UTILIZACIÓN/UTILISATION LIMITES

- Liquid temperature between -10°C and +120°C
  - Ambient temperature between 0°C and +50°C
  - Max. working pressure 25 bar/Continuous S1
- Temperatura del líquido de -10 °C hasta +120 °C
  - Temperatura ambiente de 0 °C hasta +50 °C
  - Presión máxima 25 bar/Continuo S1
- Température du liquide entre -10 °C et +120 °C
  - Température ambiante entre 0 °C et +50 °C
  - Max. pression de service 25 bar/Continu S1

#### TECHNICAL DATA/DATOS TÉCNICOS/DONNÉES TECHNIQUES

MODEL MODELO MODÈLE	Flow Caudal Débit m <sup>3</sup> /h	Head Altura Hauteur m	Pump Bomba Pompe	Power Potencia Puissance kw	Tank size ΦxL	User no.
PBWS23/8-2C	8	23	PVT 4-2	0.75	Φ600x1.3	25
PBWS36/8-2C	8	36	PVT 4-3	1.1	Φ600x1.3	25
PBWS48/8-2C	8	48	PVT 4-4	1.5	Φ600x1.3	25
PBWS60/8-2C	8	60	PVT 4-5	2.2	Φ600x1.3	25
PBWS72/8-2C	8	72	PVT 4-6	2.2	Φ600x1.3	25
PBWS84/8-2C	8	84	PVT 4-7	3	Φ600x1.3	25
PBWS95/8-2C	8	95	PVT 4-8	3	Φ600x1.3	25
PBWS120/8-2C	8	120	PVT 4-10	4	Φ600x1.3	25
PBWS145/8-2C	8	145	PVT 4-12	4	Φ600x1.3	25
PBWS170/8-2C	8	170	PVT 4-14	5.5	Φ600x1.3	25
PBWS196/8-2C	8	196	PVT 4-16	5.5	Φ600x1.3	25
PBWS12/16-2C	16	12	PVT 8-2-1	0.75	Φ600x1.3	80
PBWS26/16-2C	16	26	PVT 8-2	1.5	Φ600x1.3	80
PBWS40/16-2C	16	40	PVT 8-3	2.2	Φ600x1.3	80
PBWS54/16-2C	16	54	PVT 8-4	3	Φ600x1.3	80
PBWS68/16-2C	16	68	PVT 8-5	3	Φ600x1.3	80
PBWS82/16-2C	16	82	PVT 8-6	4	Φ600x1.3	80
PBWS110/16-2C	16	110	PVT 8-8	5.5	Φ600x1.3	80
PBWS140/16-2C	16	140	PVT 8-10	7.5	Φ600x1.3	80
PBWS167/16-2C	16	167	PVT 8-12	7.5	Φ600x1.3	80
PBWS195/16-2C	16	195	PVT 8-14	11	Φ600x1.3	80
PBWS12/20-2C	20	12	PVT 10-1	0.75	Φ600x1.3	80
PBWS25/20-2C	20	25	PVT 10-2	1.5	Φ600x1.3	80
PBWS38/20-2C	20	38	PVT 10-3	2.2	Φ600x1.3	80
PBWS51/20-2C	20	51	PVT 10-4	3	Φ600x1.3	80
PBWS64/20-2C	20	64	PVT 10-5	3	Φ600x1.3	80
PBWS77/20-2C	20	77	PVT 10-6	4	Φ600x1.3	80
PBWS90/20-2C	20	90	PVT 10-7	5.5	Φ600x1.3	80
PBWS103/20-2C	20	103	PVT 10-8	5.5	Φ600x1.3	80
PBWS116/20-2C	20	116	PVT 10-9	5.5	Φ600x1.3	80
PBWS129/20-2C	20	129	PVT 10-10	7.5	Φ600x1.3	80
PBWS156/20-2C	20	156	PVT 10-12	7.5	Φ600x1.3	80
PBWS183/20-2C	20	183	PVT 10-14	11	Φ600x1.3	80
PBWS210/20-2C	20	210	PVT 10-16	11	Φ600x1.3	80
PBWS224/20-2C	20	224	PVT 10-17	11	Φ600x1.3	80
PBWS14.5/24-2C	24	14.5	PVT 12-1	1.1	Φ800x1.5	150
PBWS32/24-2C	24	32	PVT 12-2	2.2	Φ800x1.5	150
PBWS48/24-2C	24	48	PVT 12-3	4	Φ800x1.5	150
PBWS64/24-2C	24	64	PVT 12-4	5.5	Φ800x1.5	150

#### 60Hz n=3500r/min 60 Hz n=3500 1/min

MODEL MODELO MODÈLE	Flow Caudal Débit m <sup>3</sup> /h	Head Altura Hauteur m	Pump Bomba Pompe	Power Potencia Puissance kw	Tank size ΦxL	User no.
PBWS80/24-2C	24	80	PVT 12-5	5.5	Φ800x1.5	150
PBWS96/24-2C	24	96	PVT 12-6	7.5	Φ800x1.5	150
PBWS112/24-2C	24	112	PVT 12-7	7.5	Φ800x1.5	150
PBWS128/24-2C	24	128	PVT 12-8	11	Φ800x1.5	150
PBWS161/24-2C	24	161	PVT 12-10	11	Φ800x1.5	150
PBWS193/24-2C	24	193	PVT 12-12	15	Φ800x1.5	150
PBWS225/24-2C	24	225	PVT 12-14	15	Φ800x1.5	150
PBWS17/32-2C	32	17	PVT 16-2-1	2.2	Φ800x1.5	220
PBWS35/32-2C	32	35	PVT 16-2	4	Φ800x1.5	220
PBWS54/32-2C	32	54	PVT 16-3	5.5	Φ800x1.5	220
PBWS72/32-2C	32	72	PVT 16-4	7.5	Φ800x1.5	220
PBWS90/32-2C	32	90	PVT 16-5	11	Φ800x1.5	220
PBWS108/32-2C	32	108	PVT 16-6	11	Φ800x1.5	220
PBWS126/32-2C	32	126	PVT 16-7	15	Φ800x1.5	220
PBWS144/32-2C	32	144	PVT 16-8	15	Φ800x1.5	220
PBWS181/32-2C	32	181	PVT 16-10	18.5	Φ800x1.5	220
PBWS17/40-2C	40	17	PVT 20-1	2.2	Φ800x1.5	260
PBWS35/40-2C	40	35	PVT 20-2	4	Φ800x1.5	260
PBWS53/40-2C	40	53	PVT 20-3	5.5	Φ800x1.5	260
PBWS72/40-2C	40	72	PVT 20-4	7.5	Φ800x1.5	260
PBWS90/40-2C	40	90	PVT 20-5	11	Φ800x1.5	260
PBWS108/40-2C	40	108	PVT 20-6	11	Φ800x1.5	260
PBWS127/40-2C	40	127	PVT 20-7	15	Φ800x1.5	260
PBWS146/40-2C	40	146	PVT 20-8	15	Φ800x1.5	260
PBWS185/40-2C	40	185	PVT 20-10	18.5	Φ800x1.5	260
PBWS17/64-2C	64	17	PVT 32-10-1	3	Φ1000x2.0	500
PBWS23/64-2C	64	23	PVT 32-10	4	Φ1000x2.0	500
PBWS35/64-2C	64	35	PVT 32-20-2	5.5	Φ1000x2.0	500
PBWS45/64-2C	64	45	PVT 32-20	7.5	Φ1000x2.0	500
PBWS57/64-2C	64	57	PVT 32-30-2	7.5	Φ1000x2.0	500
PBWS67/64-2C	64	67	PVT 32-30	11	Φ1000x2.0	500
PBWS81/64-2C	64	81	PVT 32-40-2	11	Φ1000x2.0	500
PBWS91/64-2C	64	91	PVT 32-40	15	Φ1000x2.0	500
PBWS102/64-2C	64	102	PVT 32-50-2	15	Φ1000x2.0	500
PBWS112/64-2C	64	112	PVT 32-50	18.5	Φ1000x2.0	500
PBWS126/64-2C	64	126	PVT 32-60-2	18.5	Φ1000x2.0	500
PBWS136/64-2C	64	136	PVT 32-60	18.5	Φ1000x2.0	500
PBWS149/64-2C	64	149	PVT 32-70-2	22	Φ1000x2.0	500
PBWS159/64-2C	64	159	PVT 32-70	22	Φ1000x2.0	500

## TECHNICAL DATA/DATOS TÉCNICOS/DONNÉES TECHNIQUES

60Hz n=3500r/min

MODEL MODELO MODÈLE	Flow Caudal Débit	Head Altura Hauteur	Pump Bomba Pompe	Power Potencia Puissance	Tank size	User no.
	m <sup>3</sup> /h	m		kw	ΦxL	
PBWS172/64-2C	64	172	PVT 32-80-2	22	Φ1000x2.0	500
PBWS181/64-2C	64	181	PVT 32-80	30	Φ1000x2.0	500
PBWS194/64-2C	64	194	PVT 32-90-2	30	Φ1000x2.0	500
PBWS204/64-2C	64	204	PVT 32-90	30	Φ1000x2.0	500
PBWS217/64-2C	64	217	PVT 32-100-2	30	Φ1000x2.0	500
PBWS25/90-2C	90	25	PVT 45-10-1	5.5	Φ1000x2.0	600
PBWS30/90-2C	90	30	PVT 45-10	7.5	Φ1000x2.0	600
PBWS49/90-2C	90	49	PVT 45-20-2	11	Φ1000x2.0	600
PBWS61/90-2C	90	61	PVT 45-20	15	Φ1000x2.0	600
PBWS80/90-2C	90	80	PVT 45-30-2	18.5	Φ1000x2.0	600
PBWS92/90-2C	90	92	PVT 45-30	18.5	Φ1000x2.0	600
PBWS112/90-2C	90	112	PVT 45-40-2	22	Φ1000x2.0	600
PBWS123/90-2C	90	123	PVT 45-40	30	Φ1000x2.0	600
PBWS142/90-2C	90	142	PVT 45-50-2	30	Φ1000x2.0	600
PBWS154/90-2C	90	154	PVT 45-50	30	Φ1000x2.0	600
PBWS173/90-2C	90	173	PVT 45-60-2	37	Φ1000x2.0	600
PBWS186/90-2C	90	186	PVT 45-60	37	Φ1000x2.0	600
PBWS205/90-2C	90	205	PVT 45-70-2	45	Φ1000x2.0	600
PBWS216/90-2C	90	216	PVT 45-70	45	Φ1000x2.0	600
PBWS22/130-2C	130	22	PVT 64-10-1	7.5	Φ1200x2.0	1200
PBWS32/130-2C	130	32	PVT 64-10	11	Φ1200x2.0	1200
PBWS44/130-2C	130	44	PVT 64-20-2	15	Φ1200x2.0	1200
PBWS64/130-2C	130	64	PVT 64-20	22	Φ1200x2.0	1200
PBWS76/130-2C	130	76	PVT 64-30-2	22	Φ1200x2.0	1200
PBWS96/130-2C	130	96	PVT 64-30	30	Φ1200x2.0	1200
PBWS110/130-2C	130	110	PVT 64-40-2	37	Φ1200x2.0	1200
PBWS130/130-2C	130	130	PVT 64-40	45	Φ1200x2.0	1200
PBWS144/130-2C	130	144	PVT 64-50-2	45	Φ1200x2.0	1200
PBWS23/180-2C	180	23	PVT 90-10-1	11	Φ1200x2.0	1600
PBWS30/180-2C	180	30	PVT 90-10	15	Φ1200x2.0	1600
PBWS48/180-2C	180	48	PVT 90-20-2	18.5	Φ1200x2.0	1600
PBWS57/180-2C	180	57	PVT 90-20-1	22	Φ1200x2.0	1600
PBWS64/180-2C	180	64	PVT 90-20	30	Φ1200x2.0	1600
PBWS82/180-2C	180	82	PVT 90-30-2	37	Φ1200x2.0	1600
PBWS90/180-2C	180	90	PVT 90-30-1	37	Φ1200x2.0	1600
PBWS97/180-2C	180	97	PVT 90-30	45	Φ1200x2.0	1600
PBWS118/180-2C	180	118	PVT 90-40-2	45	Φ1200x2.0	1600

MODEL MODELO MODÈLE	Flow Caudal Débit	Head Altura Hauteur	Pump Bomba Pompe	Power Potencia Puissance	Tank size	User no.
	m <sup>3</sup> /h	m		kw	ΦxL	
PBWS23/12-3C	12	23	PVT 4-2	0.75	Φ600x1.3	50
PBWS36/12-3C	12	36	PVT 4-3	1.1	Φ600x1.3	50
PBWS48/12-3C	12	48	PVT 4-4	1.5	Φ600x1.3	50
PBWS60/12-3C	12	60	PVT 4-5	2.2	Φ600x1.3	50
PBWS72/12-3C	12	72	PVT 4-6	2.2	Φ600x1.3	50
PBWS84/12-3C	12	84	PVT 4-7	3	Φ600x1.3	50
PBWS95/12-3C	12	95	PVT 4-8	3	Φ600x1.3	50
PBWS120/12-3C	12	120	PVT 4-10	4	Φ600x1.3	50
PBWS145/12-3C	12	145	PVT 4-12	4	Φ600x1.3	50
PBWS170/12-3C	12	170	PVT 4-14	5.5	Φ600x1.3	50
PBWS196/12-3C	12	196	PVT 4-16	5.5	Φ600x1.3	50
PBWS12/24-3C	24	12	PVT 8-2-1	0.75	Φ800x1.5	150
PBWS26/24-3C	24	26	PVT 8-2	1.5	Φ800x1.5	150
PBWS40/24-3C	24	40	PVT 8-3	2.2	Φ800x1.5	150
PBWS54/24-3C	24	54	PVT 8-4	3	Φ800x1.5	150
PBWS68/24-3C	24	68	PVT 8-5	3	Φ800x1.5	150
PBWS82/24-3C	24	82	PVT 8-6	4	Φ800x1.5	150
PBWS110/24-3C	24	110	PVT 8-8	5.5	Φ800x1.5	150
PBWS140/24-3C	24	140	PVT 8-10	7.5	Φ800x1.5	150
PBWS167/24-3C	24	167	PVT 8-12	7.5	Φ800x1.5	150
PBWS195/24-3C	24	195	PVT 8-14	11	Φ800x1.5	150
PBWS12/30-3C	30	12	PVT 10-1	0.75	Φ800x1.5	150
PBWS25/30-3C	30	25	PVT 10-2	1.5	Φ800x1.5	150
PBWS38/30-3C	30	38	PVT 10-3	2.2	Φ800x1.5	150
PBWS51/30-3C	30	51	PVT 10-4	3	Φ800x1.5	150
PBWS64/30-3C	30	64	PVT 10-5	3	Φ800x1.5	150
PBWS77/30-3C	30	77	PVT 10-6	4	Φ800x1.5	150
PBWS90/30-3C	30	90	PVT 10-7	5.5	Φ800x1.5	150
PBWS103/30-3C	30	103	PVT 10-8	5.5	Φ800x1.5	150
PBWS116/30-3C	30	116	PVT 10-9	5.5	Φ800x1.5	150
PBWS129/30-3C	30	129	PVT 10-10	7.5	Φ800x1.5	150
PBWS156/30-3C	30	156	PVT 10-12	7.5	Φ800x1.5	150
PBWS183/30-3C	30	183	PVT 10-14	11	Φ800x1.5	150
PBWS210/30-3C	30	210	PVT 10-16	11	Φ800x1.5	150
PBWS224/30-3C	30	224	PVT 10-17	11	Φ800x1.5	150
PBWS14.5/36-3C	36	14.5	PVT 12-1	1.1	Φ800x1.5	220
PBWS32/36-3C	36	32	PVT 12-2	2.2	Φ800x1.5	220
PBWS48/36-3C	36	48	PVT 12-3	4	Φ800x1.5	220
PBWS64/36-3C	36	64	PVT 12-4	5.5	Φ800x1.5	220

## TECHNICAL DATA/DATOS TÉCNICOS/DONNÉES TECHNIQUES

60Hz n=3500r/min

MODEL MODELO MODÈLE	Flow Caudal Débit	Head Altura Hauteur	Pump Bomba Pompe	Power Potencia Puissance	Tank size	User no.
	m <sup>3</sup> /h	m		kw	ΦxL	
PBWS80/36-3C	36	80	PVT 12-5	5.5	Φ800x1.5	220
PBWS96/36-3C	36	96	PVT 12-6	7.5	Φ800x1.5	220
PBWS112/36-3C	36	112	PVT 12-7	7.5	Φ800x1.5	220
PBWS128/36-3C	36	128	PVT 12-8	11	Φ800x1.5	220
PBWS161/36-3C	36	161	PVT 12-10	11	Φ800x1.5	220
PBWS193/36-3C	36	193	PVT 12-12	15	Φ800x1.5	220
PBWS225/36-3C	36	225	PVT 12-14	15	Φ800x1.5	220
PBWS17/48-3C	48	17	PVT 16-2-1	2.2	Φ800x1.5	300
PBWS35/48-3C	48	35	PVT 16-2	4	Φ800x1.5	300
PBWS54/48-3C	48	54	PVT 16-3	5.5	Φ800x1.5	300
PBWS72/48-3C	48	72	PVT 16-4	7.5	Φ800x1.5	300
PBWS90/48-3C	48	90	PVT 16-5	11	Φ800x1.5	300
PBWS108/48-3C	48	108	PVT 16-6	11	Φ800x1.5	300
PBWS126/48-3C	48	126	PVT 16-7	15	Φ800x1.5	300
PBWS144/48-3C	48	144	PVT 16-8	15	Φ800x1.5	300
PBWS181/48-3C	48	181	PVT 16-10	18.5	Φ800x1.5	300
PBWS17/60-3C	60	17	PVT 20-1	2.2	Φ1000x2.0	500
PBWS35/60-3C	60	35	PVT 20-2	4	Φ1000x2.0	500
PBWS53/60-3C	60	53	PVT 20-3	5.5	Φ1000x2.0	500
PBWS72/60-3C	60	72	PVT 20-4	7.5	Φ1000x2.0	500
PBWS90/60-3C	60	90	PVT 20-5	11	Φ1000x2.0	500
PBWS108/60-3C	60	108	PVT 20-6	11	Φ1000x2.0	500
PBWS127/60-3C	60	127	PVT 20-7	15	Φ1000x2.0	500
PBWS146/60-3C	60	146	PVT 20-8	15	Φ1000x2.0	500
PBWS185/60-3C	60	185	PVT 20-10	18.5	Φ1000x2.0	500
PBWS17/96-3C	96	17	PVT 32-10-1	3	Φ1000x2.0	900
PBWS23/96-3C	96	23	PVT 32-10	4	Φ1000x2.0	900
PBWS35/96-3C	96	35	PVT 32-20-2	5.5	Φ1000x2.0	900
PBWS45/96-3C	96	45	PVT 32-20	7.5	Φ1000x2.0	900
PBWS57/96-3C	96	57	PVT 32-30-2	7.5	Φ1000x2.0	900
PBWS67/96-3C	96	67	PVT 32-30	11	Φ1000x2.0	900
PBWS81/96-3C	96	81	PVT 32-40-2	11	Φ1000x2.0	900
PBWS91/96-3C	96	91	PVT 32-40	15	Φ1000x2.0	900
PBWS102/96-3C	96	102	PVT 32-50-2	15	Φ1000x2.0	900
PBWS112/96-3C	96	112	PVT 32-50	18.5	Φ1000x2.0	900
PBWS126/96-3C	96	126	PVT 32-60-2	18.5	Φ1000x2.0	900
PBWS136/96-3C	96	136	PVT 32-60	18.5	Φ1000x2.0	900
PBWS149/96-3C	96	149	PVT 32-70-2	22	Φ1000x2.0	900
PBWS159/96-3C	96	159	PVT 32-70	22	Φ1000x2.0	900

MODEL MODELO MODÈLE	Flow Caudal Débit	Head Altura Hauteur	Pump Bomba Pompe	Power Potencia Puissance	Tank size	User no.
	m <sup>3</sup> /h	m		kw	ΦxL	
PBWS172/96-3C	96	172	PVT 32-80-2	22	Φ1000x2.0	900
PBWS181/96-3C	96	181	PVT 32-80	30	Φ1000x2.0	900
PBWS194/96-3C	96	194	PVT 32-90-2	30	Φ1000x2.0	900
PBWS204/96-3C	96	204	PVT 32-90	30	Φ1000x2.0	900
PBWS217/96-3C	96	217	PVT 32-100-2	30	Φ1000x2.0	900
PBWS25/135-3C	135	25	PVT 45-10-1	5.5	Φ1200x2.0	1200
PBWS30/135-3C	135	30	PVT 45-10	7.5	Φ1200x2.0	1200
PBWS49/135-3C	135	49	PVT 45-20-2	11	Φ1200x2.0	1200
PBWS61/135-3C	135	61	PVT 45-20	15	Φ1200x2.0	1200
PBWS80/135-3C	135	80	PVT 45-30-2	18.5	Φ1200x2.0	1200
PBWS92/135-3C	135	92	PVT 45-30	18.5	Φ1200x2.0	1200
PBWS112/135-3C	135	112	PVT 45-40-2	22	Φ1200x2.0	1200
PBWS123/135-3C	135	123	PVT 45-40	30	Φ1200x2.0	1200
PBWS142/135-3C	135	142	PVT 45-50-2	30	Φ1200x2.0	1200
PBWS154/135-3C	135	154	PVT 45-50	30	Φ1200x2.0	1200
PBWS173/135-3C	135	173	PVT 45-60-2	37	Φ1200x2.0	1200
PBWS186/135-3C	135	186	PVT 45-60	37	Φ1200x2.0	1200
PBWS205/135-3C	135	205	PVT 45-70-2	45	Φ1200x2.0	1200
PBWS216/135-3C	135	216	PVT 45-70	45	Φ1200x2.0	1200
PBWS22/195-3C	195	22	PVT 64-10-1	7.5	Φ1200x2.0	1600
PBWS32/195-3C	195	32	PVT 64-10	11	Φ1200x2.0	1600
PBWS44/195-3C	195	44	PVT 64-20-2	15	Φ1200x2.0	1600
PBWS64/195-3C	195	64	PVT 64-20	22	Φ1200x2.0	1600
PBWS76/195-3C	195	76	PVT 64-30-2	22	Φ1200x2.0	1600
PBWS96/195-3C	195	96	PVT 64-30	30	Φ1200x2.0	1600
PBWS110/195-3C	195	110	PVT 64-40-2	37	Φ1200x2.0	1600
PBWS130/195-3C	195	130	PVT 64-40	45	Φ1200x2.0	1600
PBWS144/195-3C	195	144	PVT 64-50-2	45	Φ1200x2.0	1600
PBWS23/270-3C	270	23	PVT 90-10-1	11	Φ1400x2.5	2200
PBWS30/270-3C	270	30	PVT 90-10	15	Φ1400x2.5	2200
PBWS48/270-3C	270	48	PVT 90-20-2	18.5	Φ1400x2.5	2200
PBWS57/270-3C	270	57				

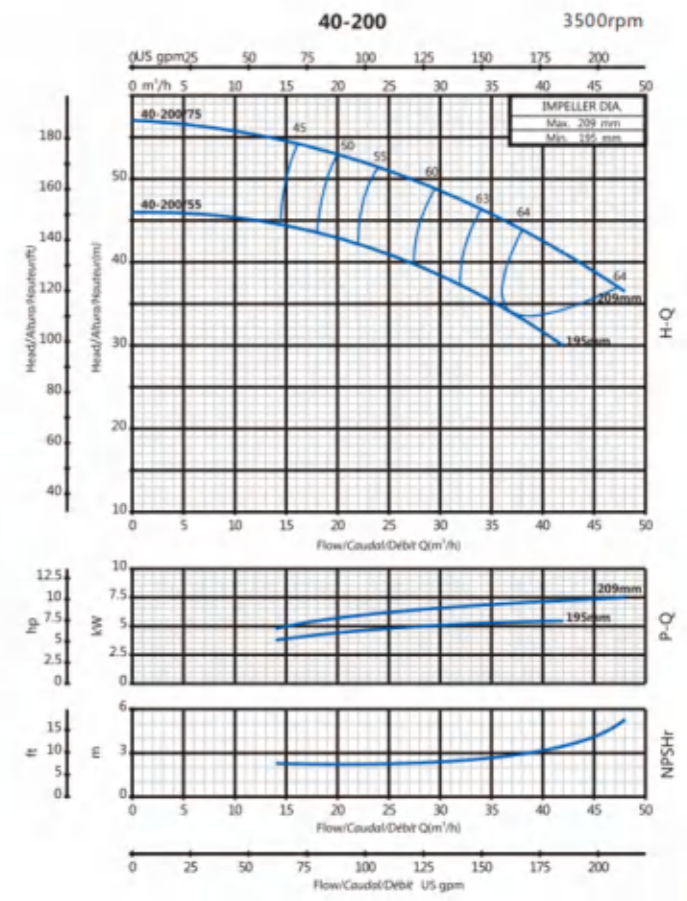
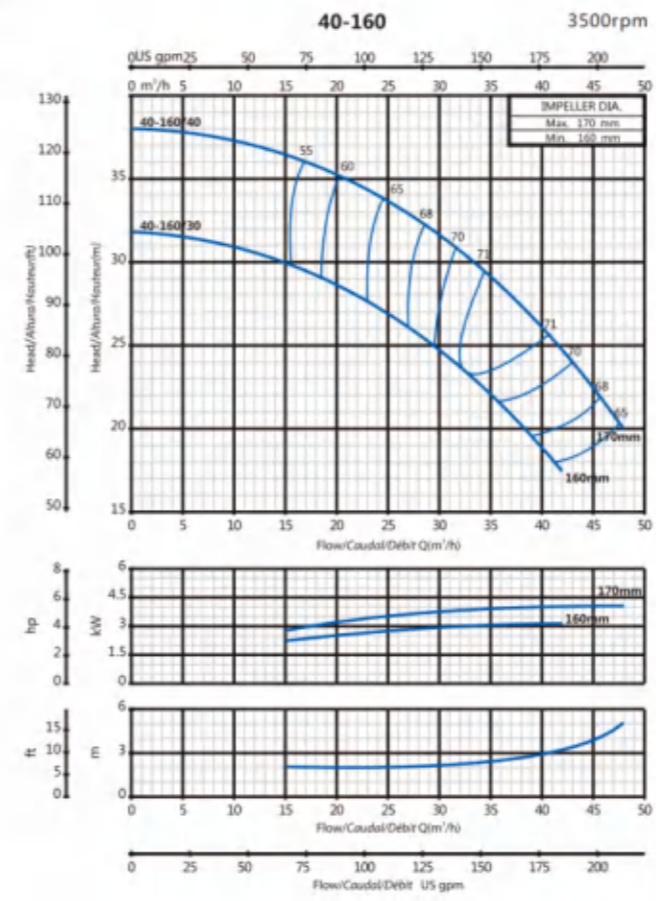
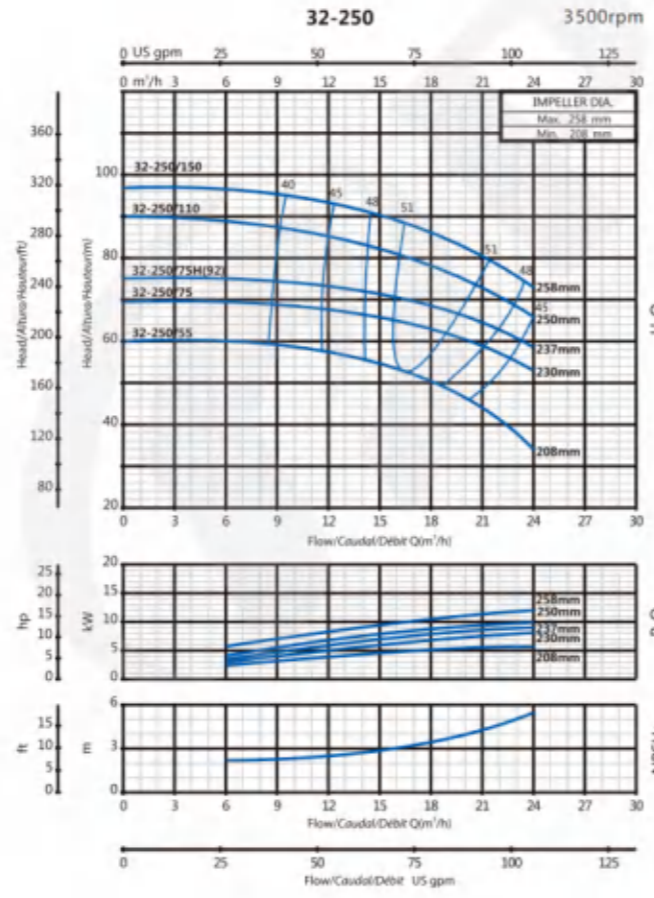
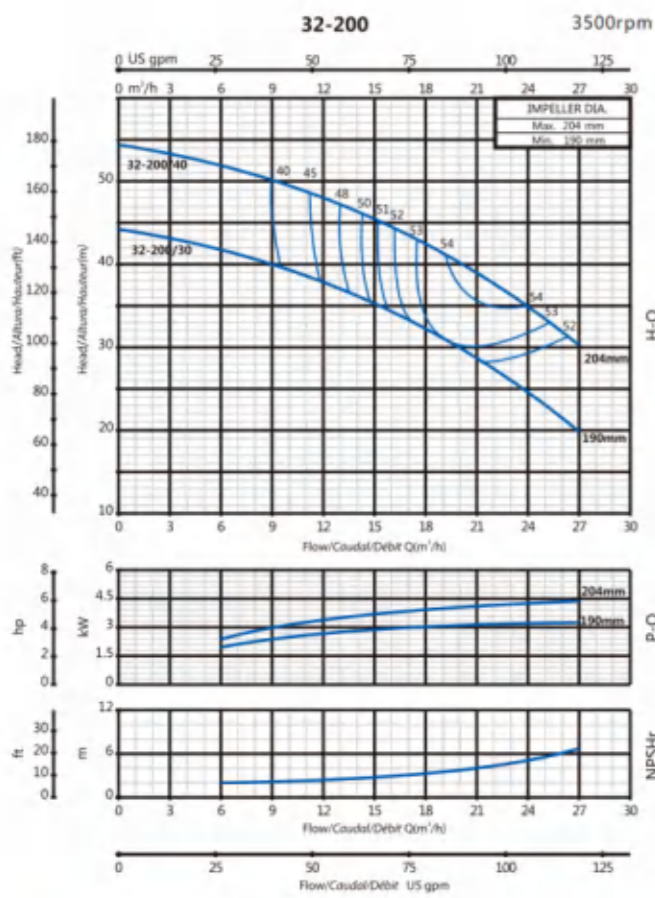
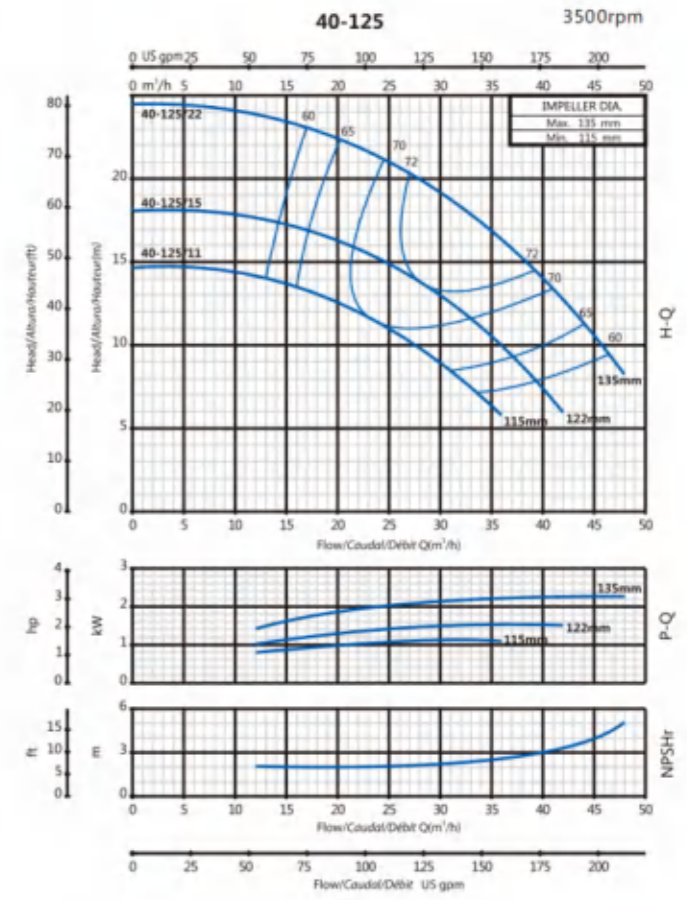
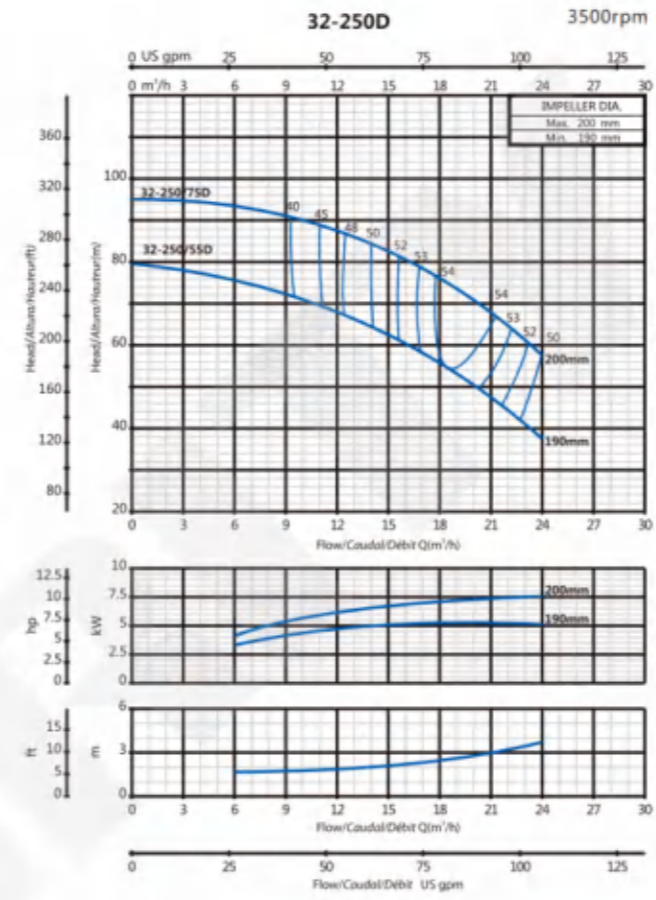
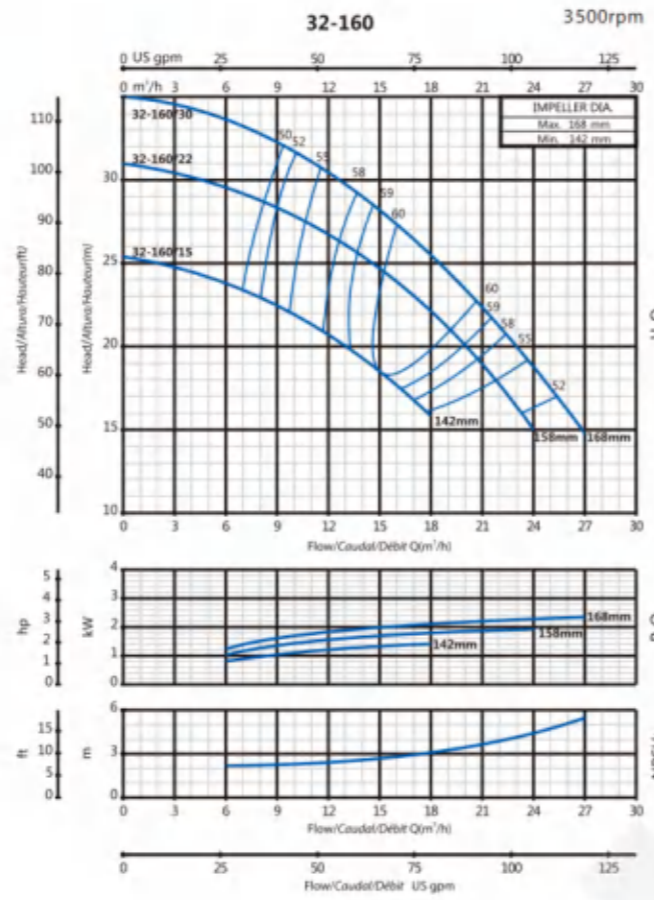
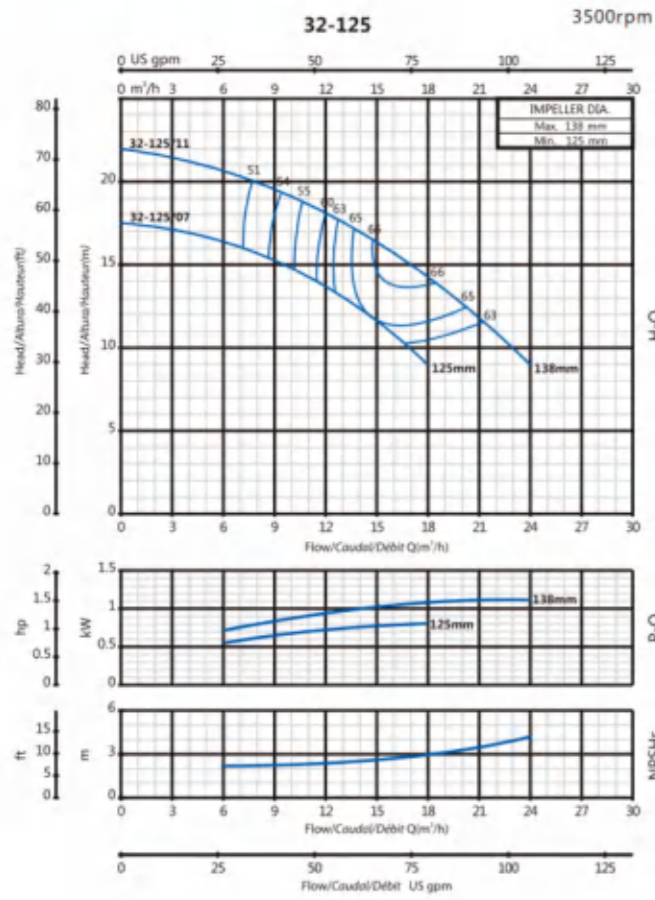



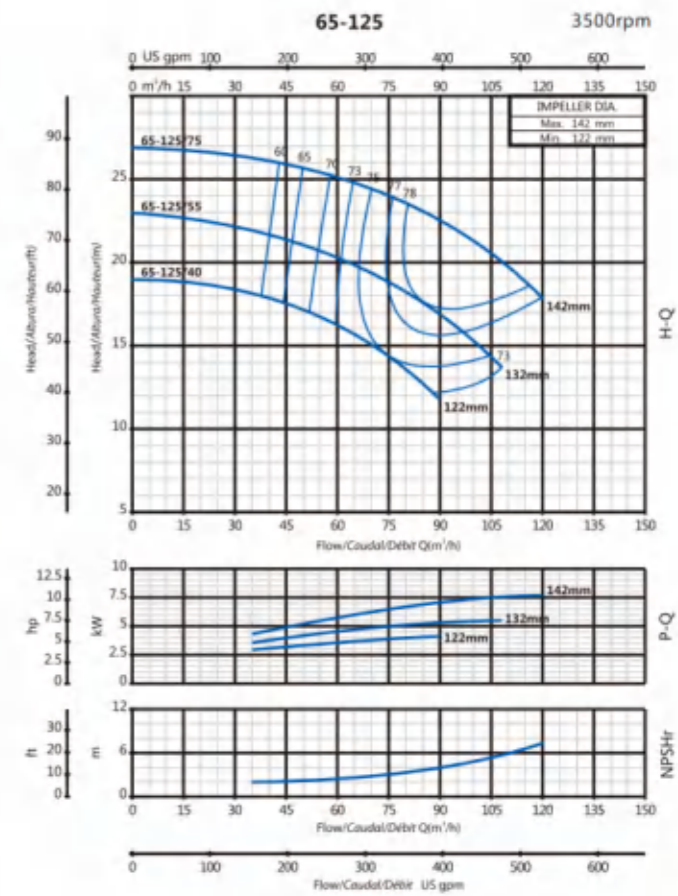
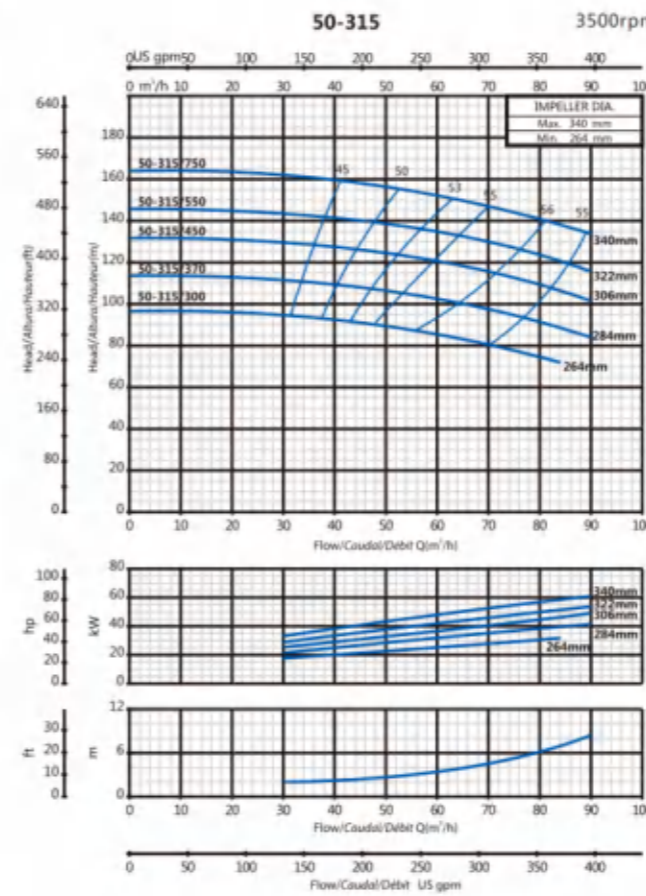
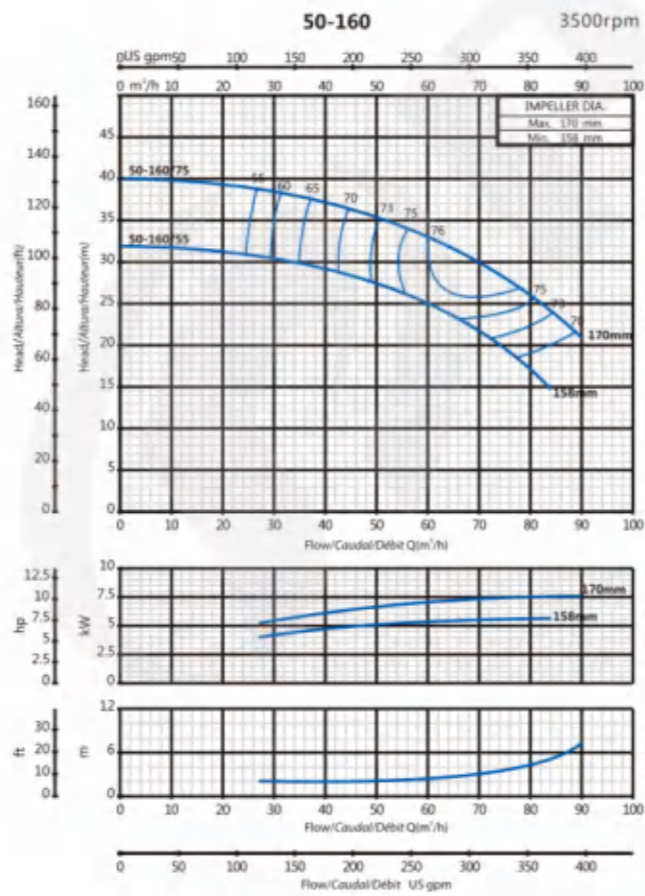
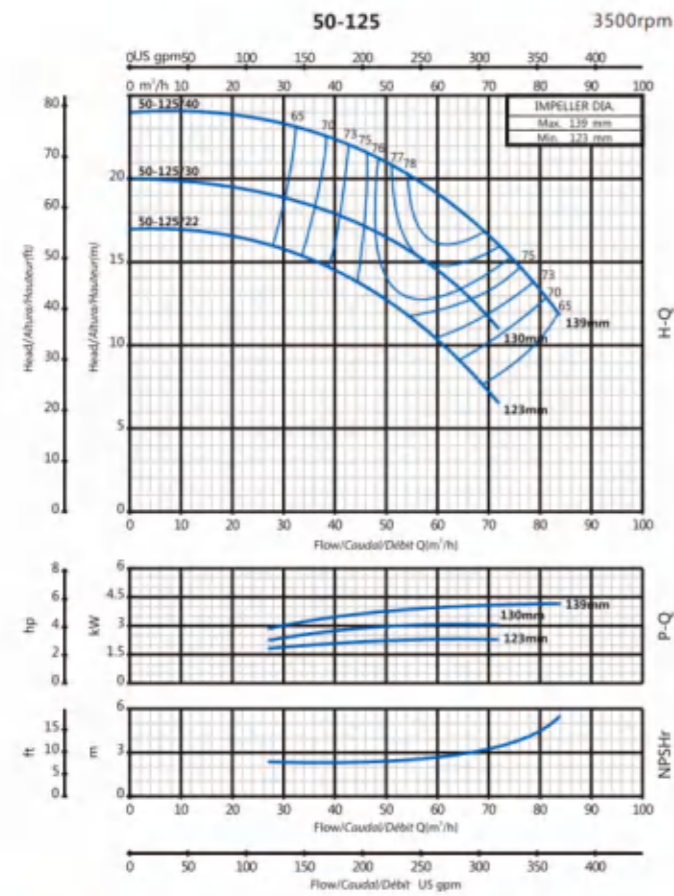
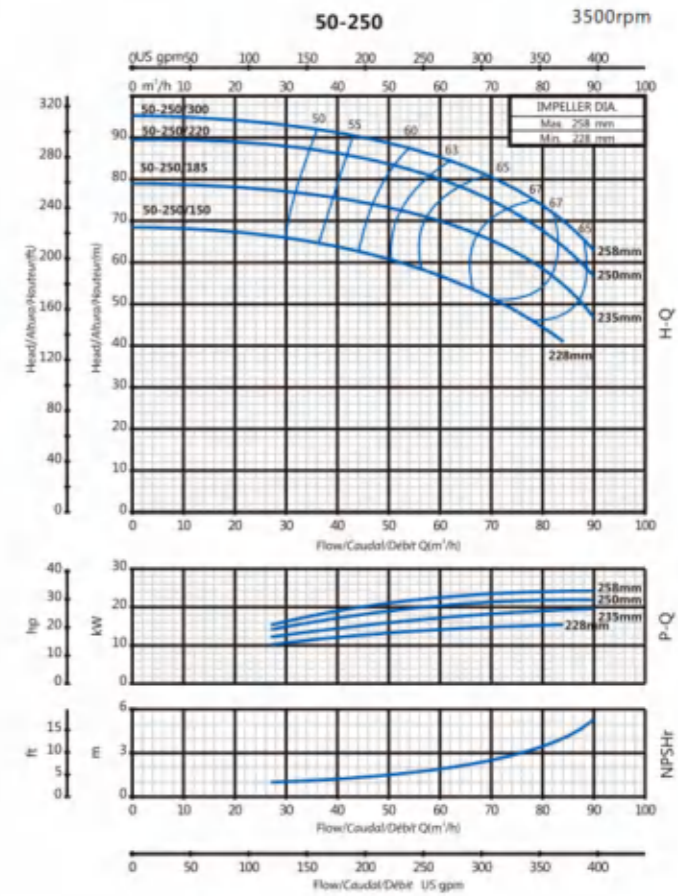
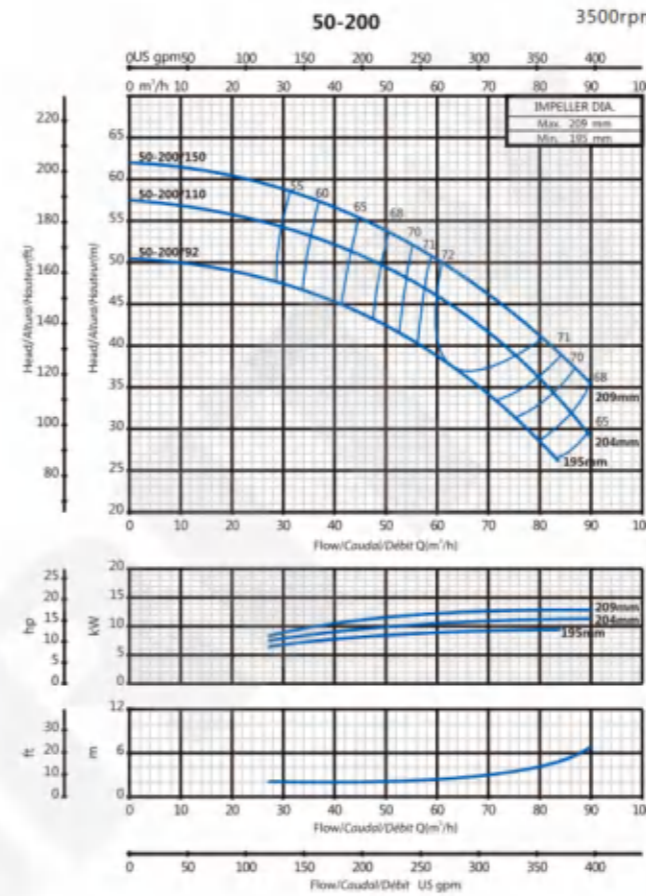
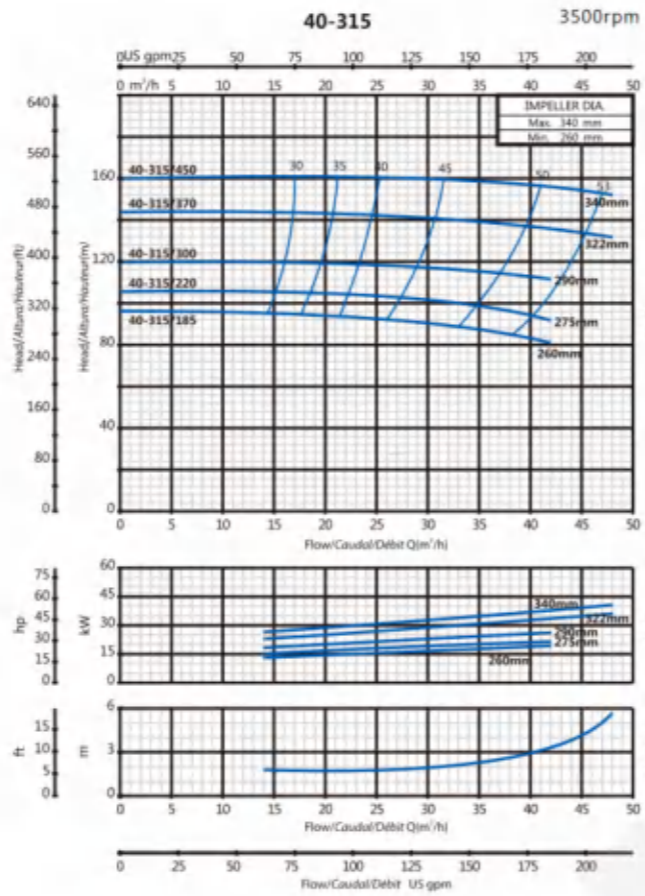
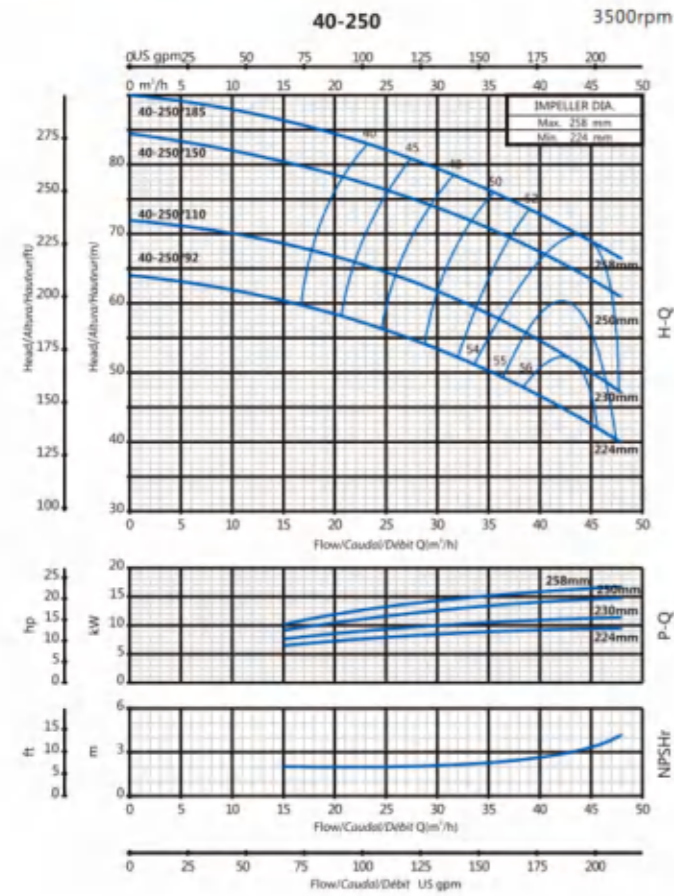

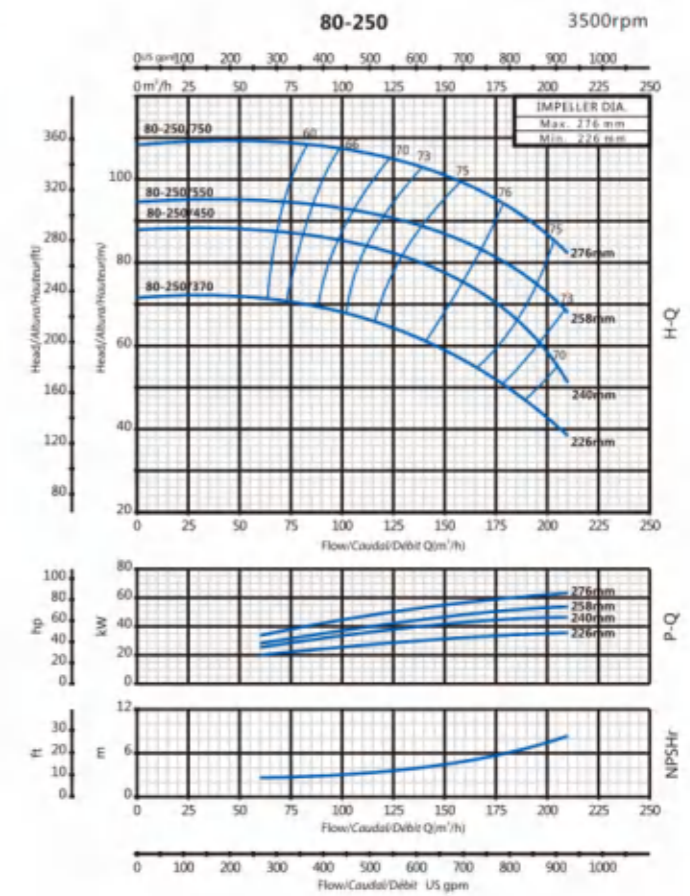
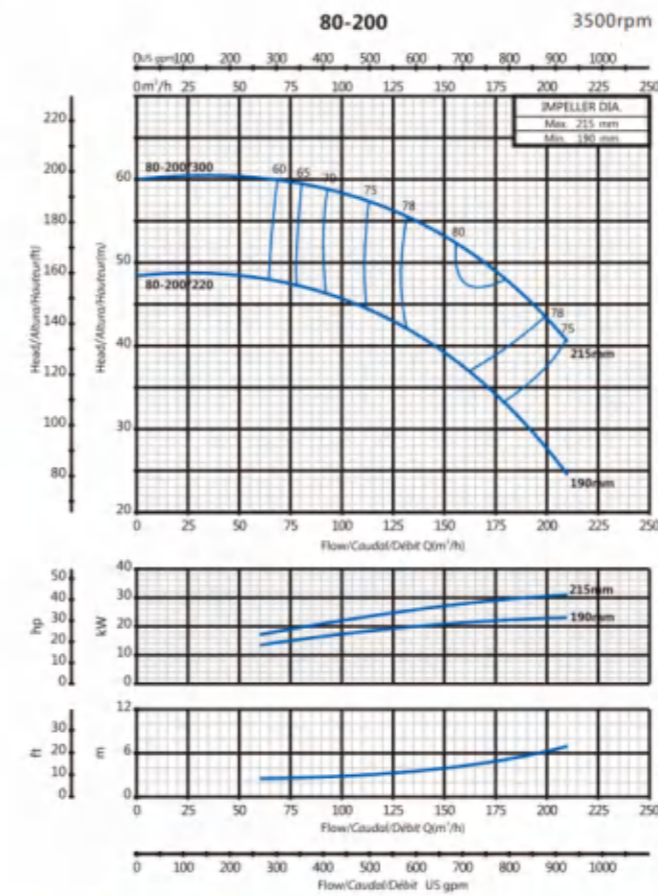
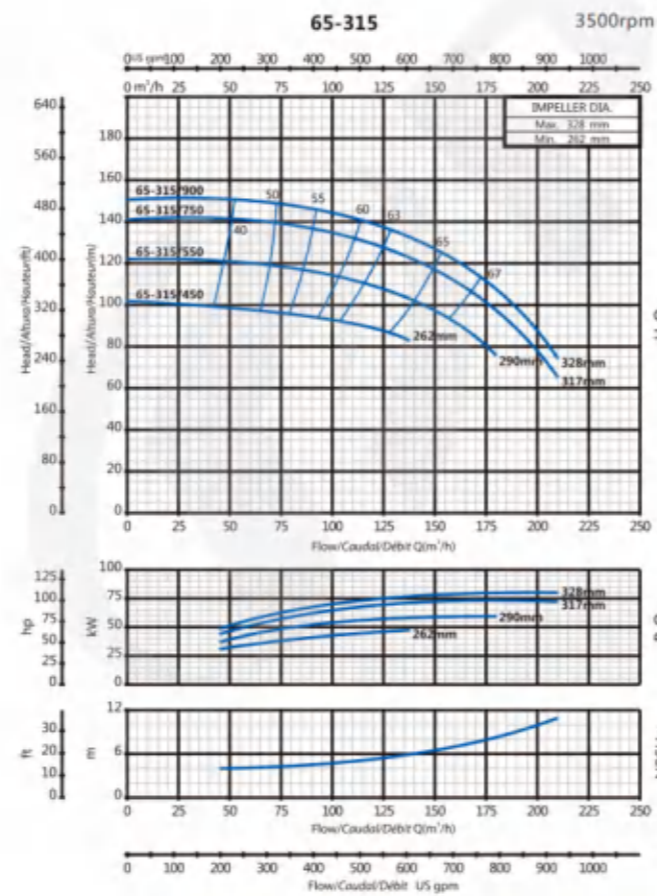
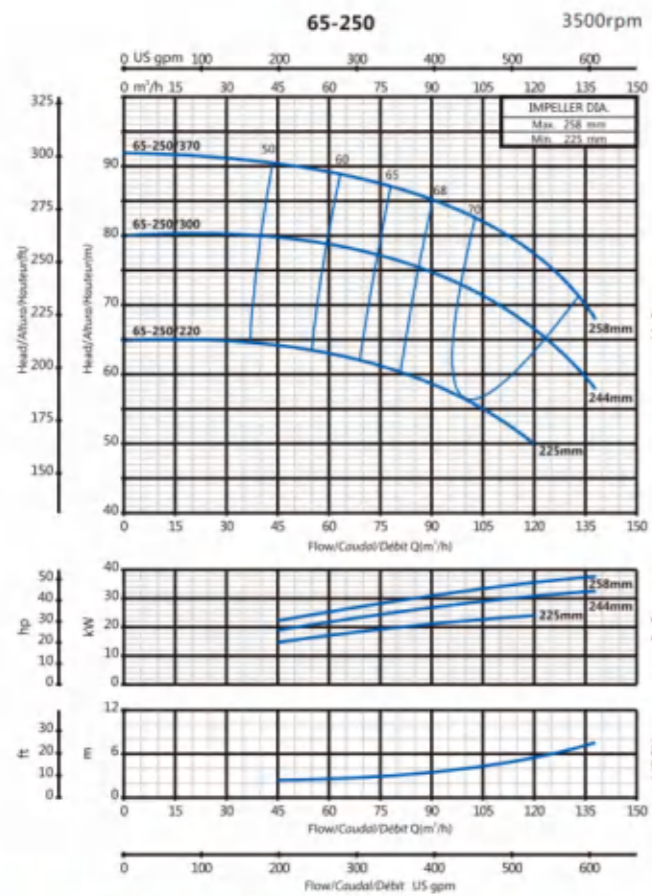
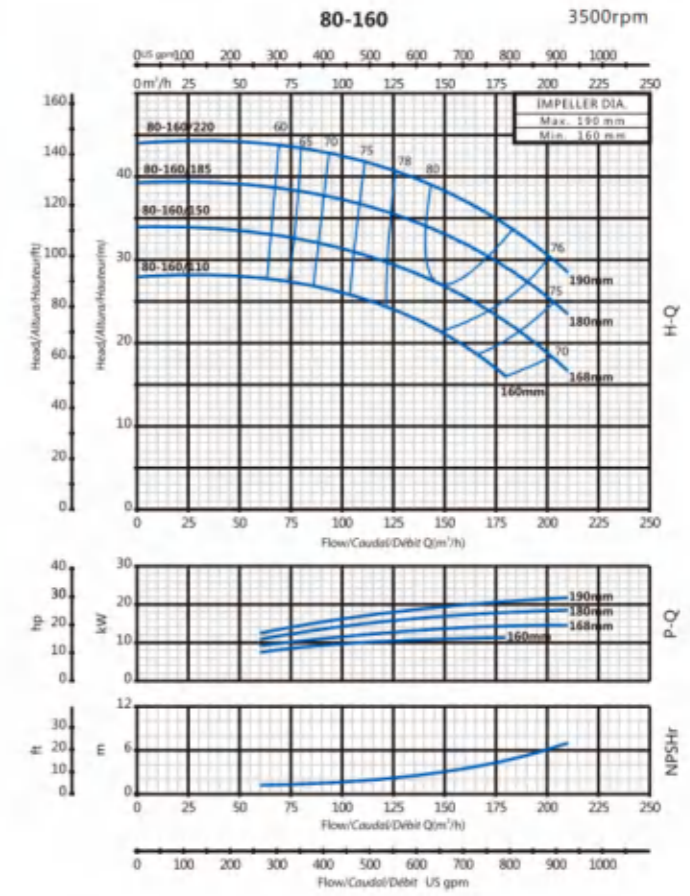
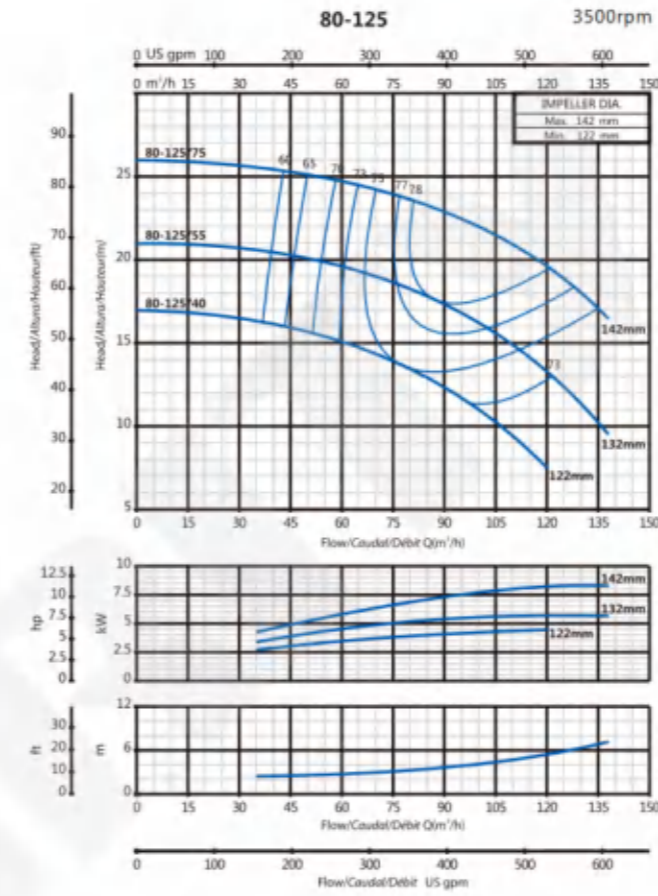
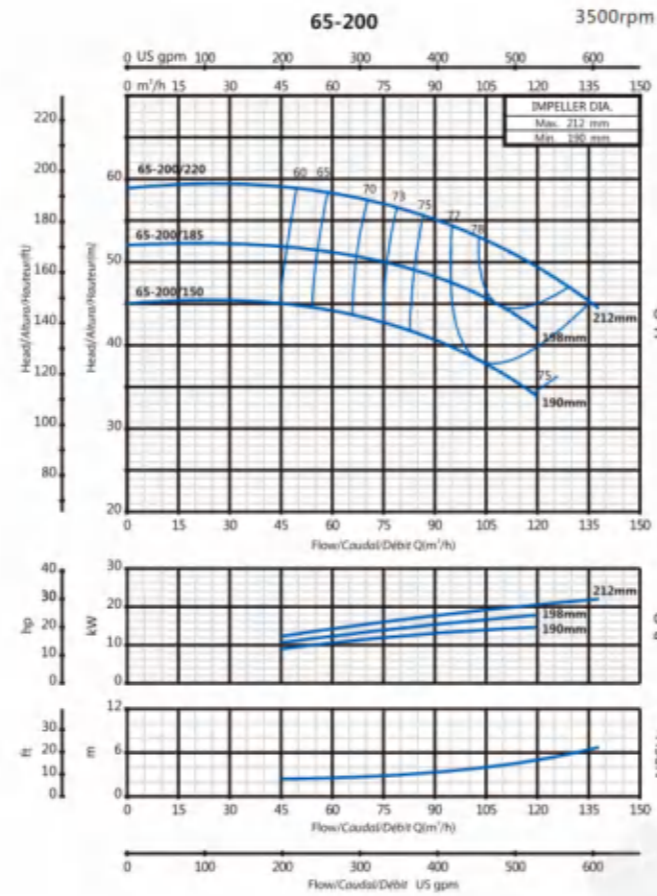
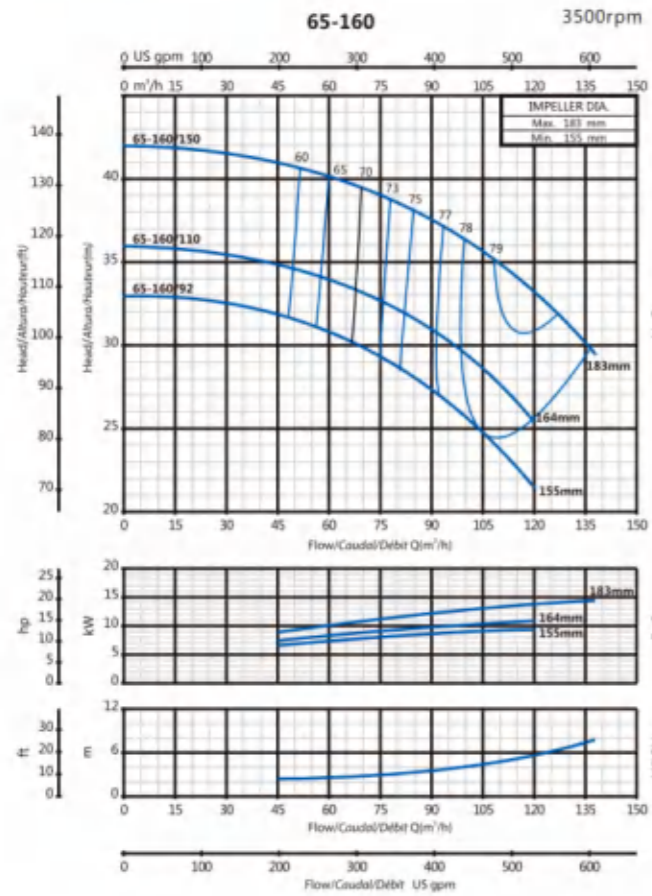

80-315

3500rpm

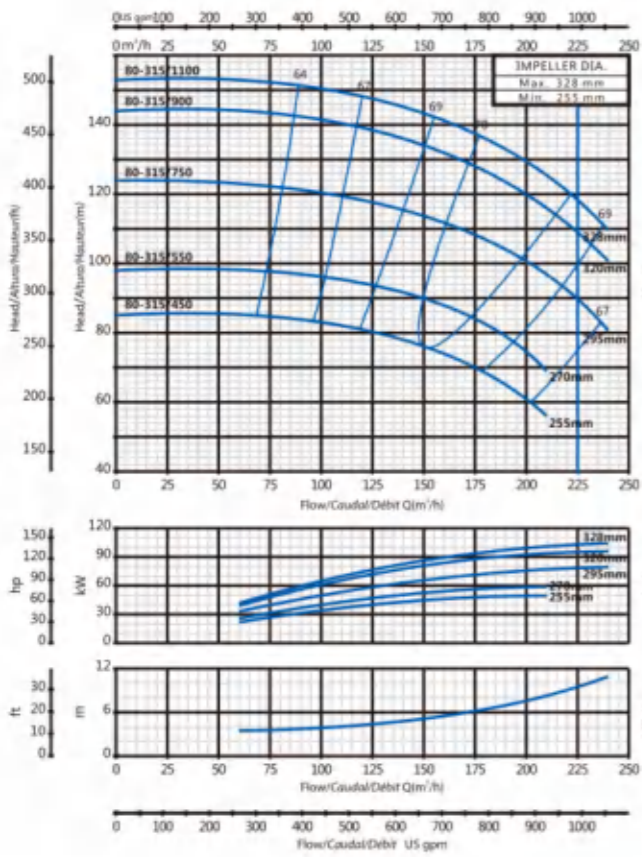

100-160

3500rpm

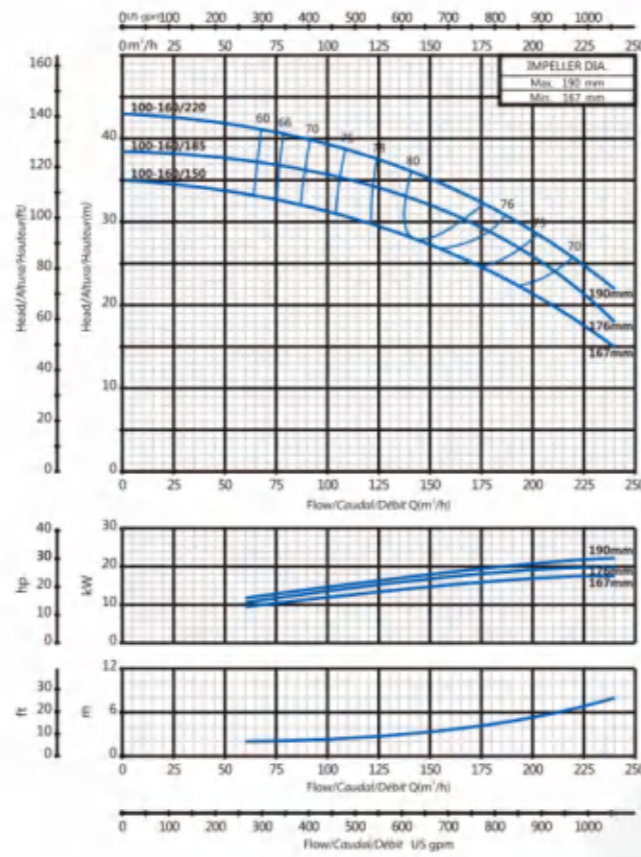

100-315

3500rpm

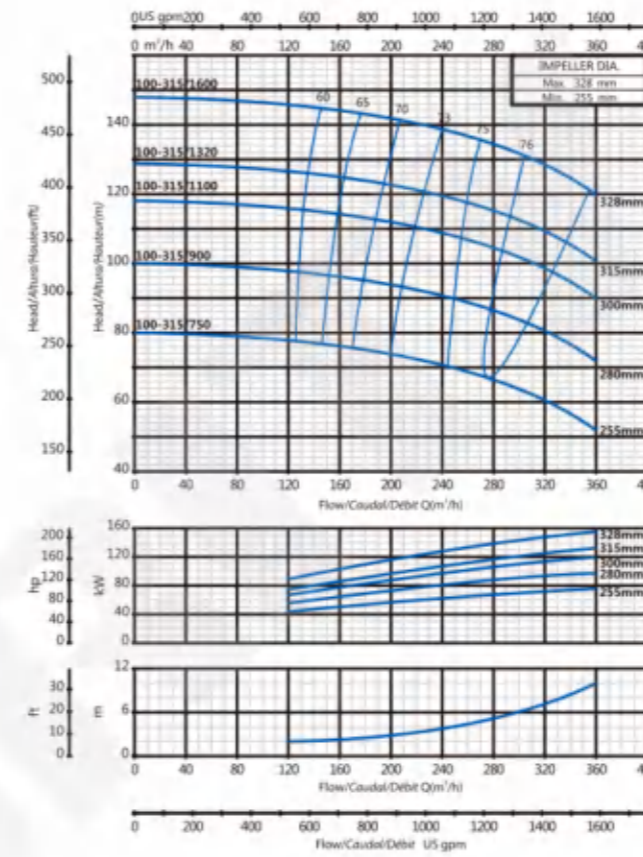

125-200

3500rpm

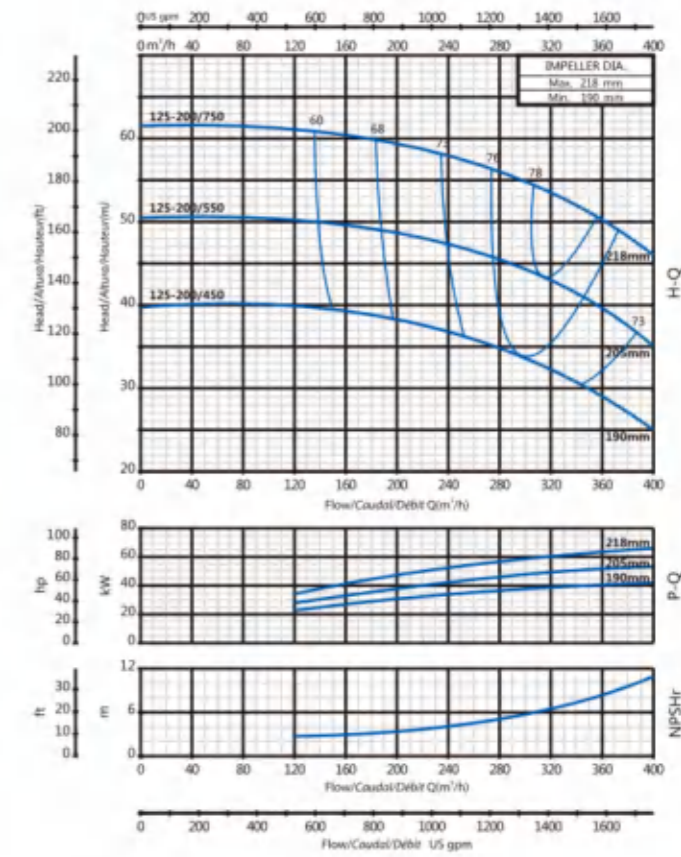

100-200

3500rpm

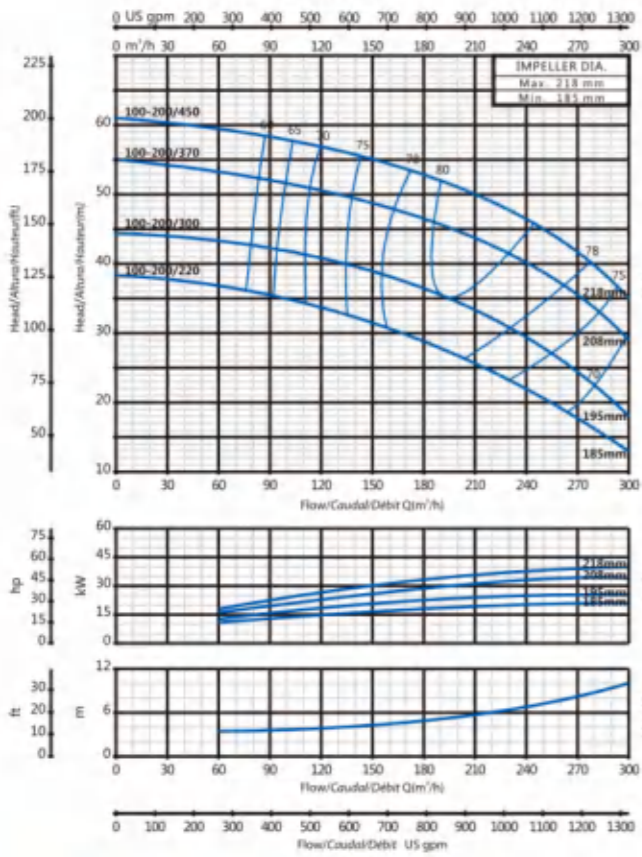

100-250

3500rpm

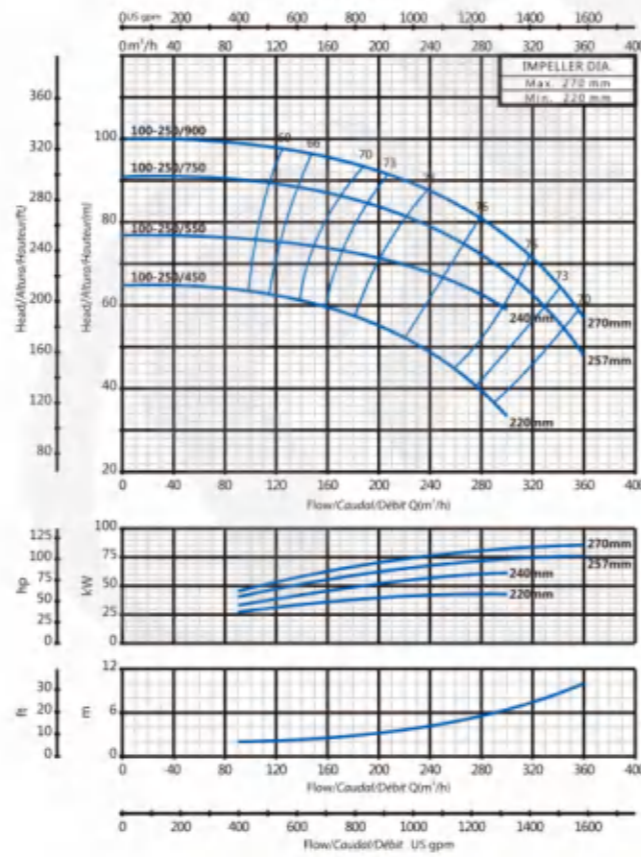

125-250

3500rpm

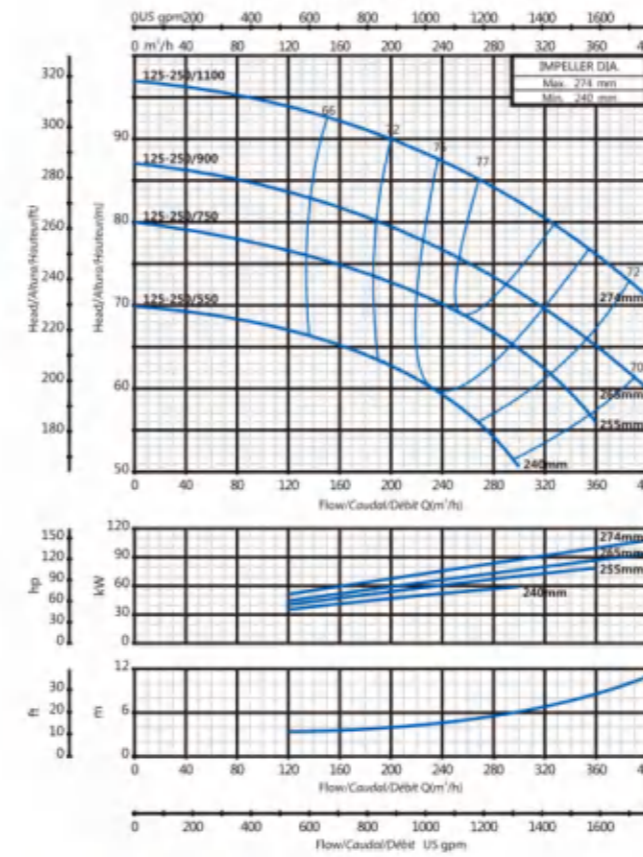

125-250H

3500rpm

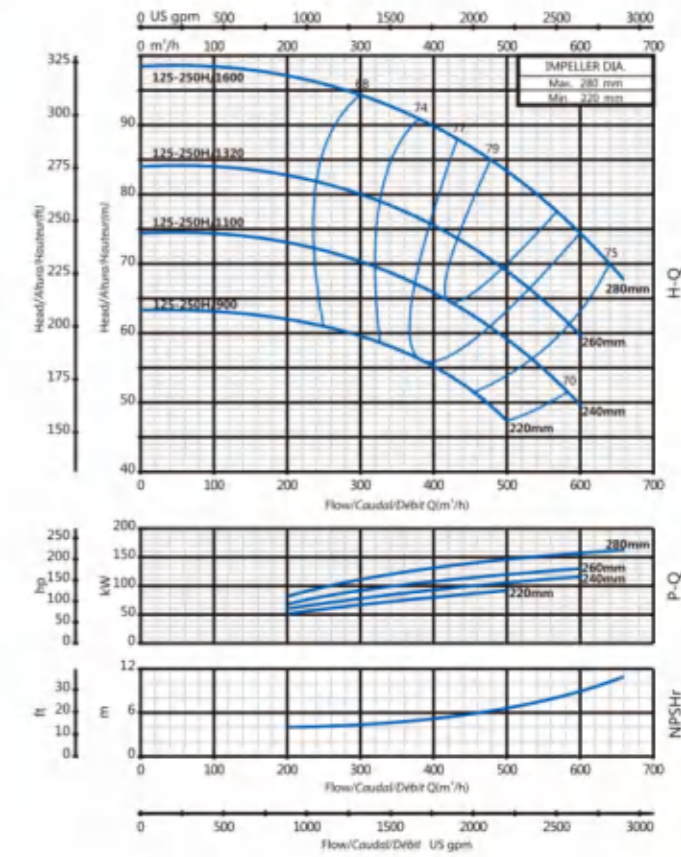

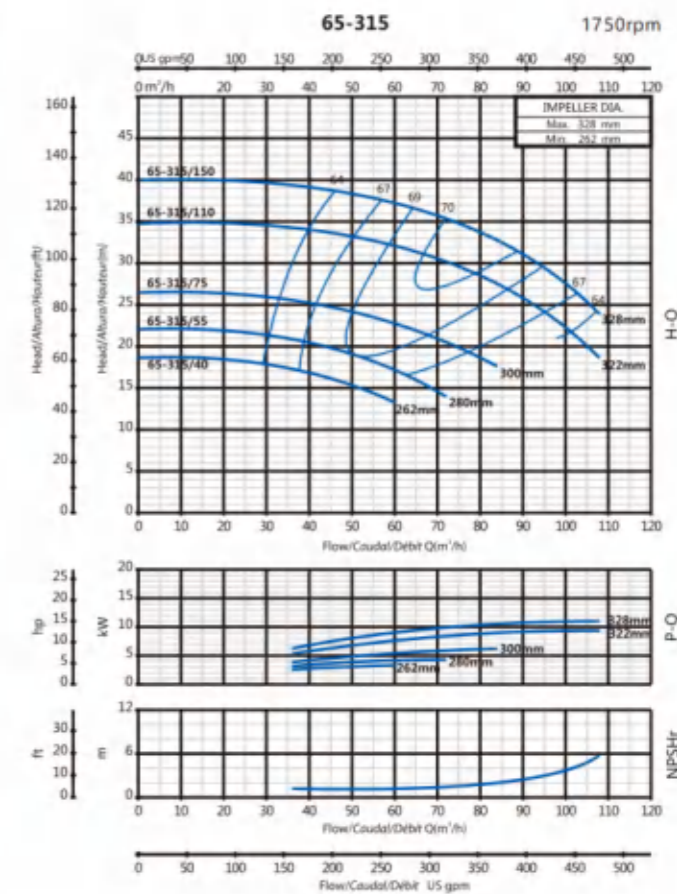
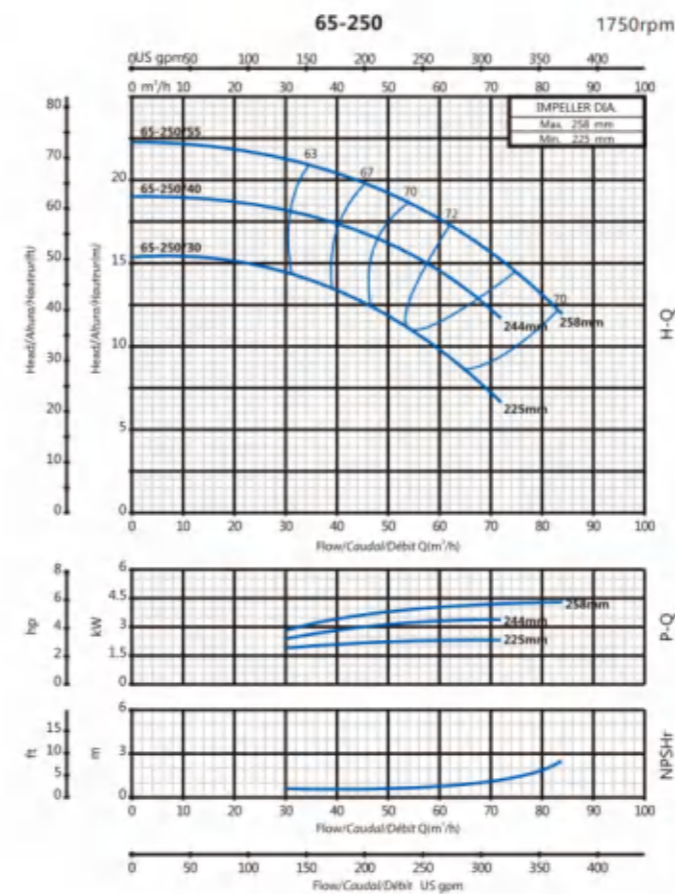
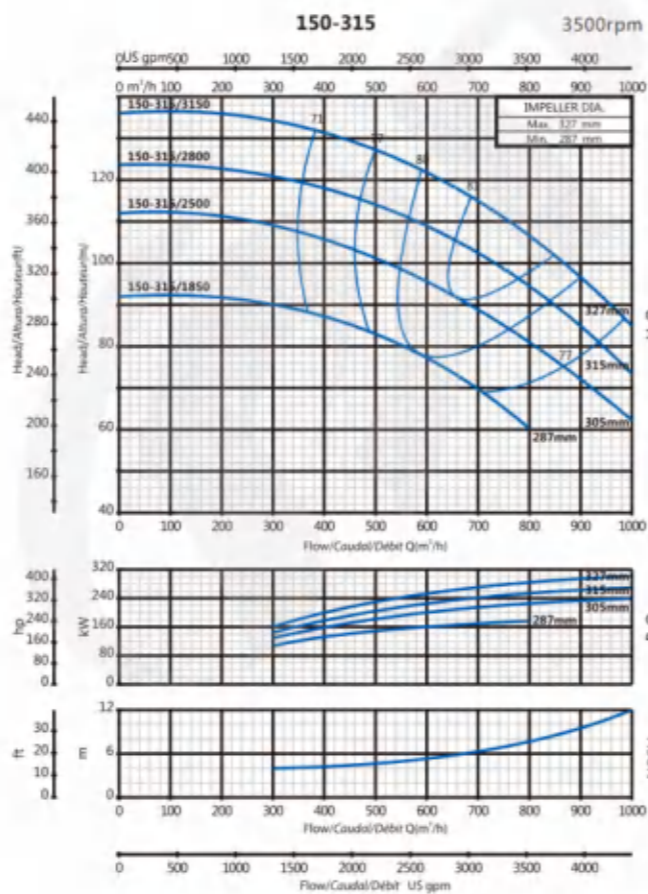
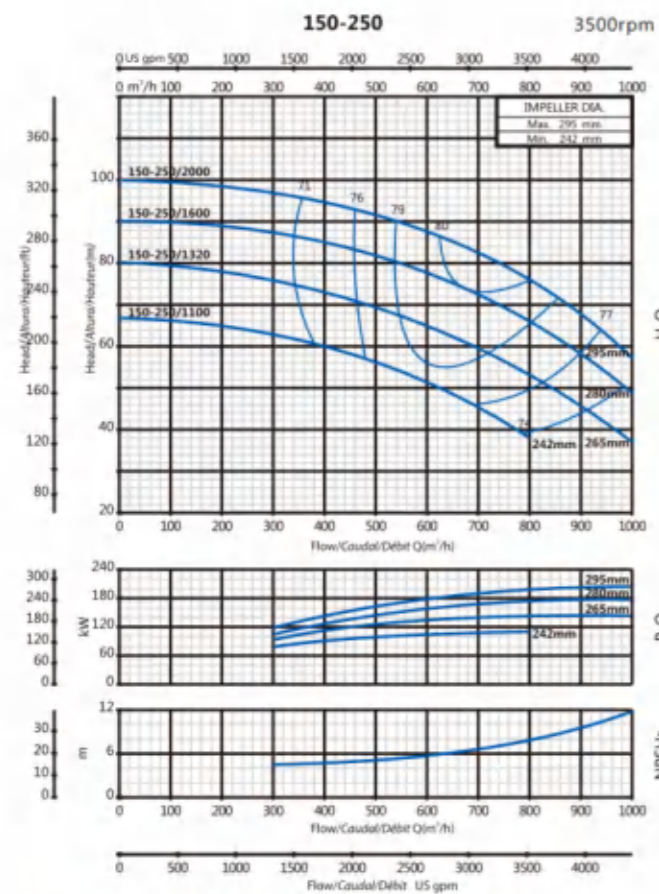
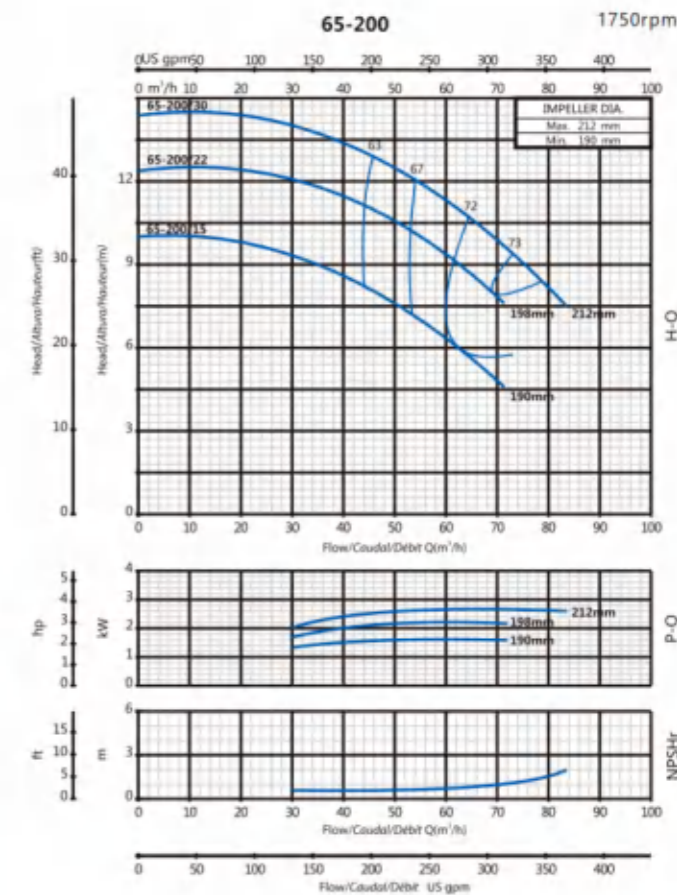
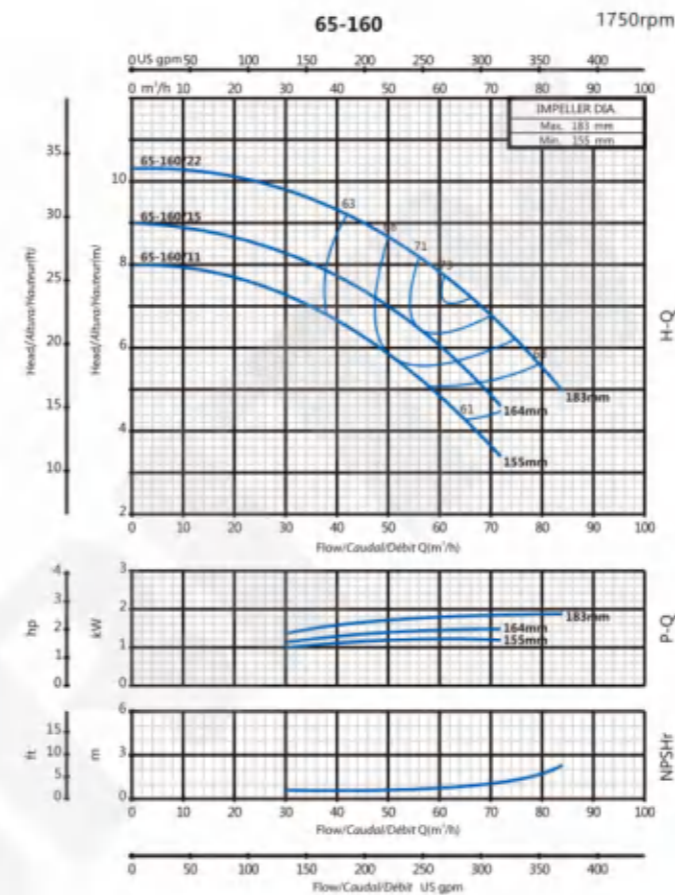
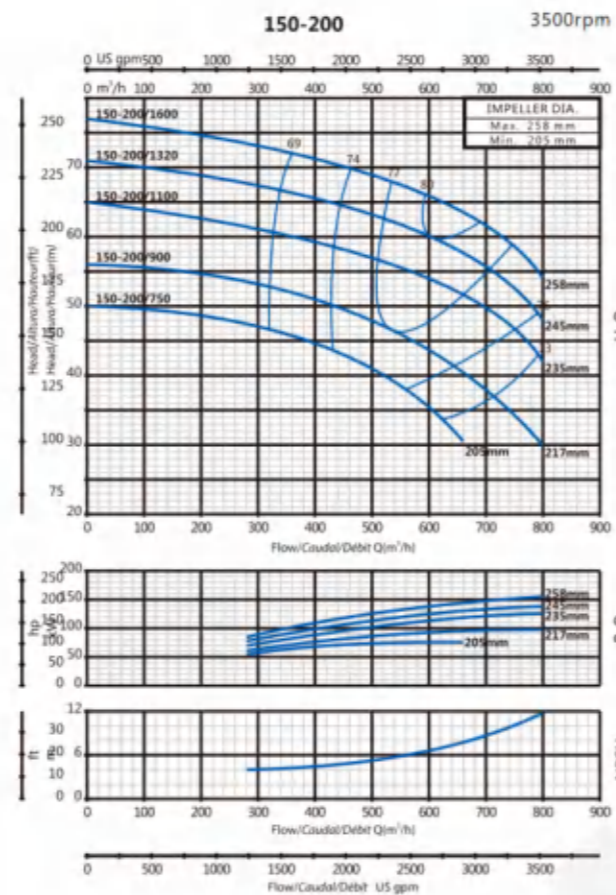
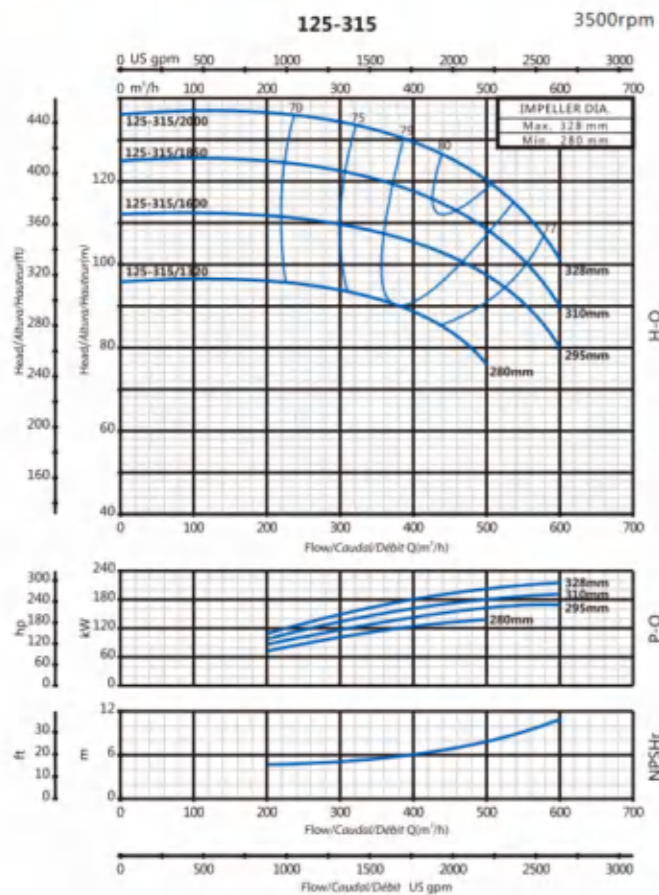

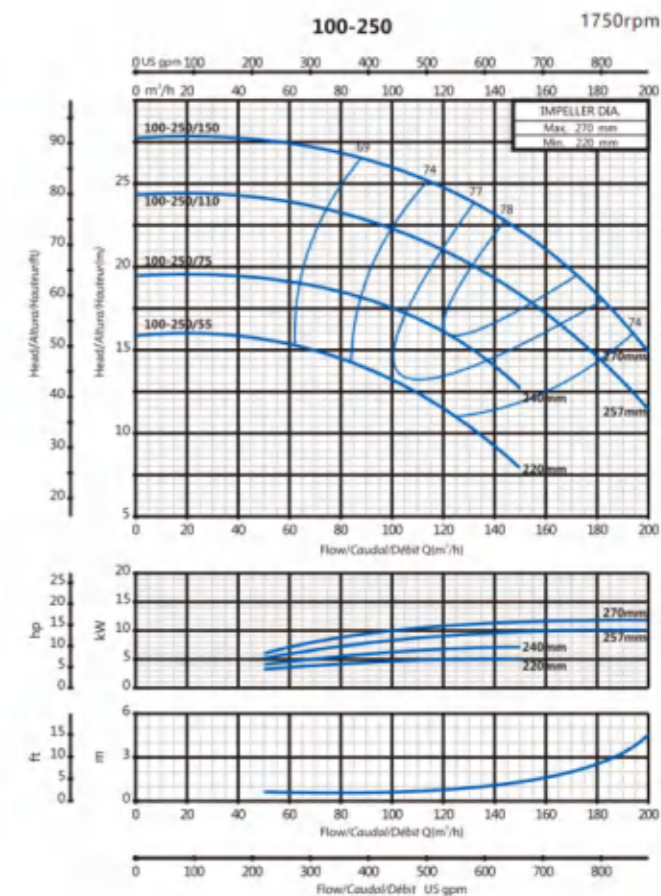
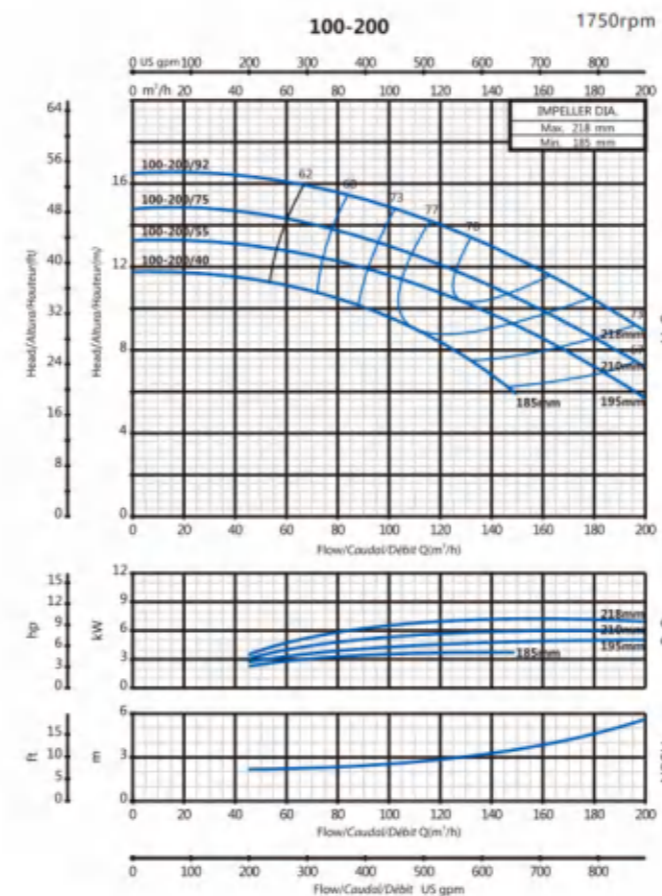
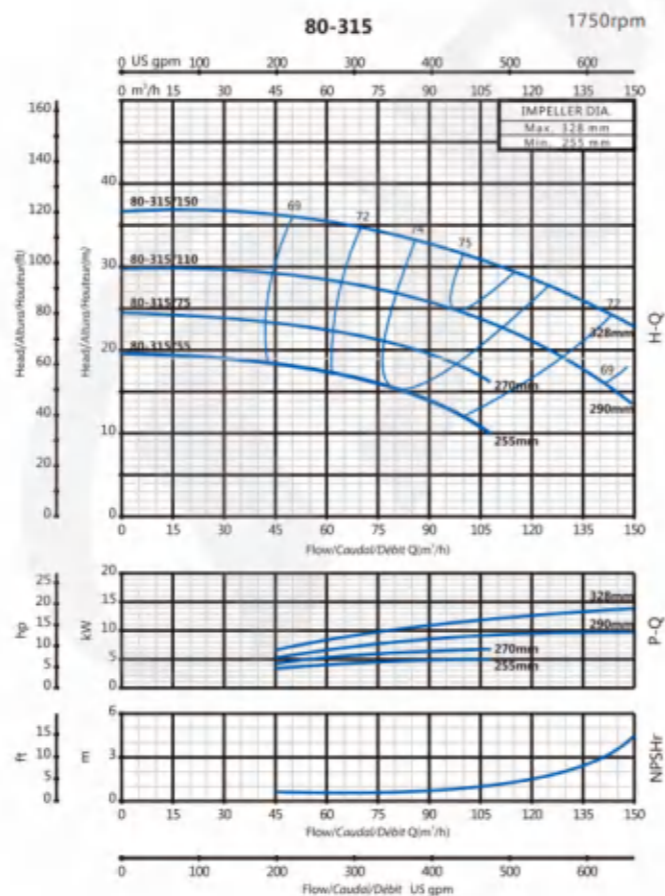
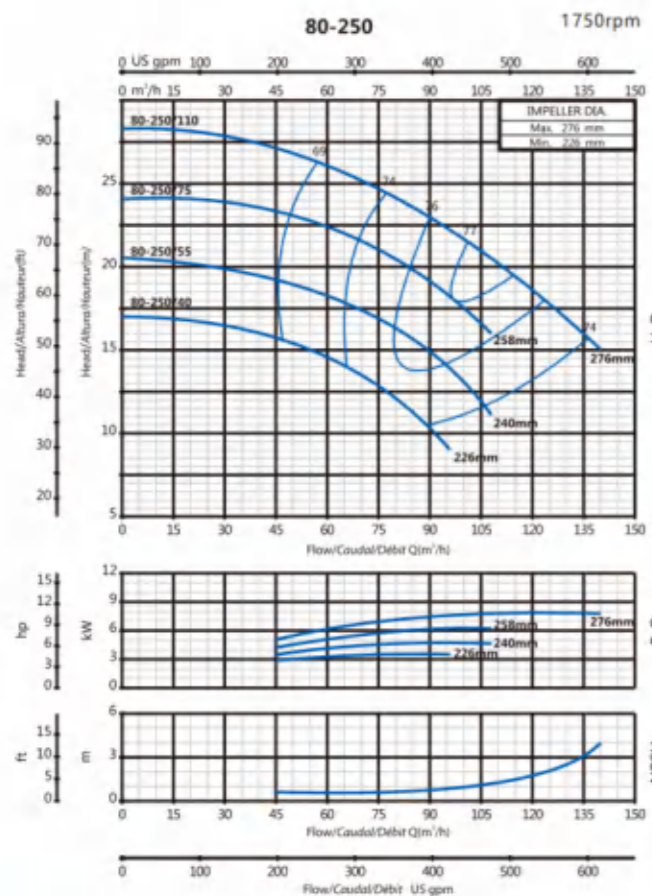
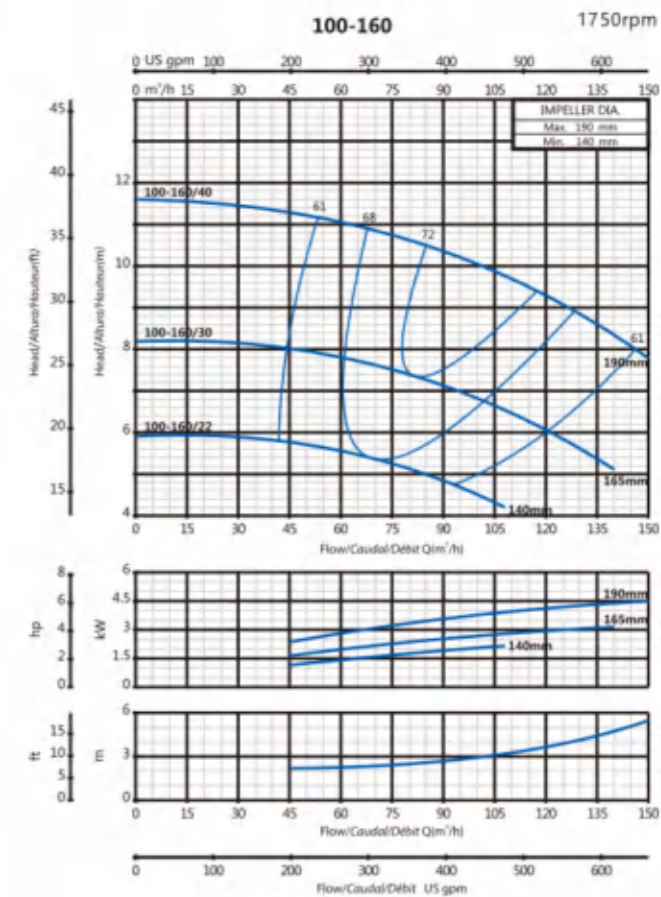
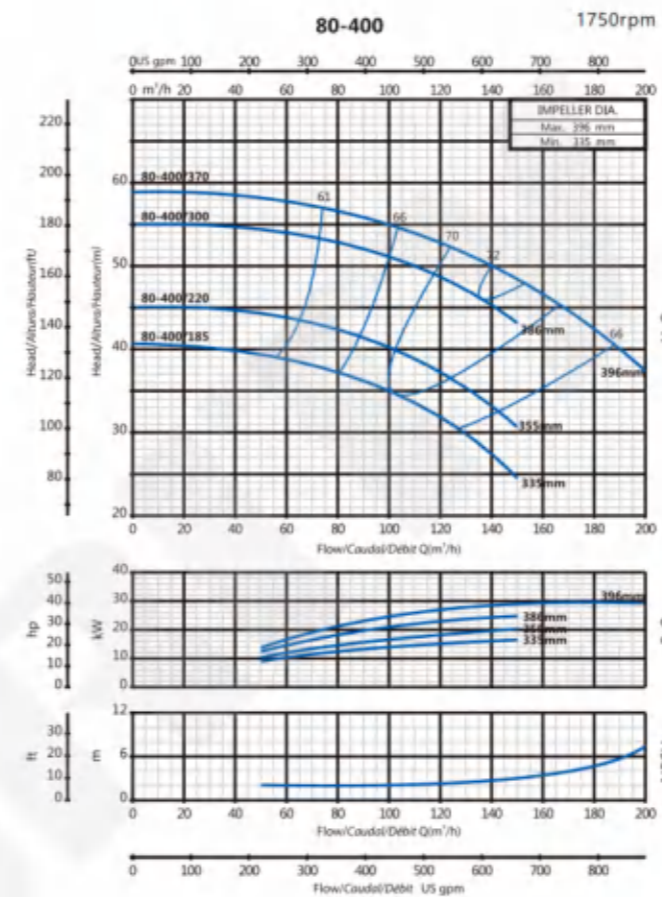
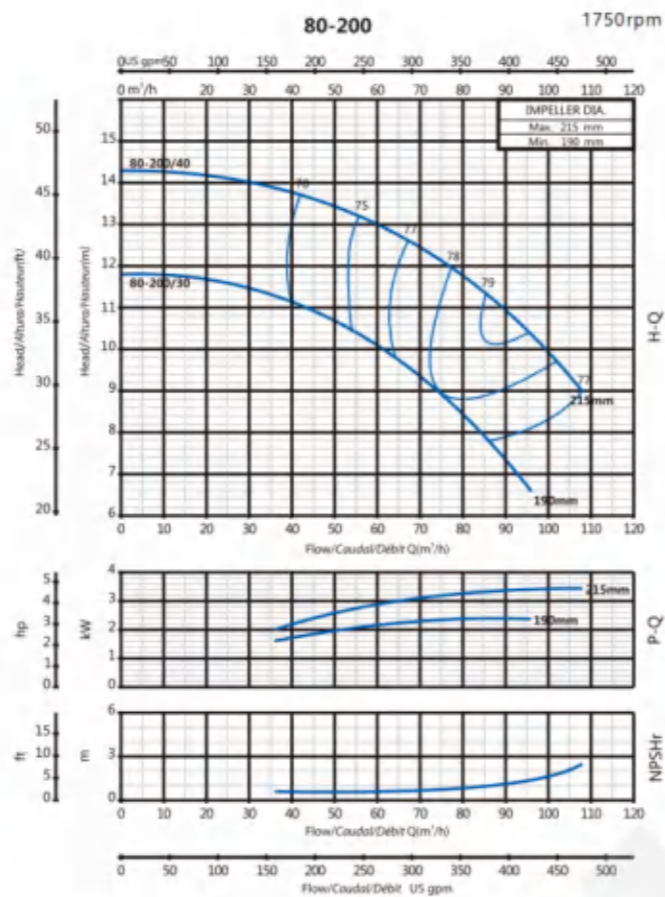
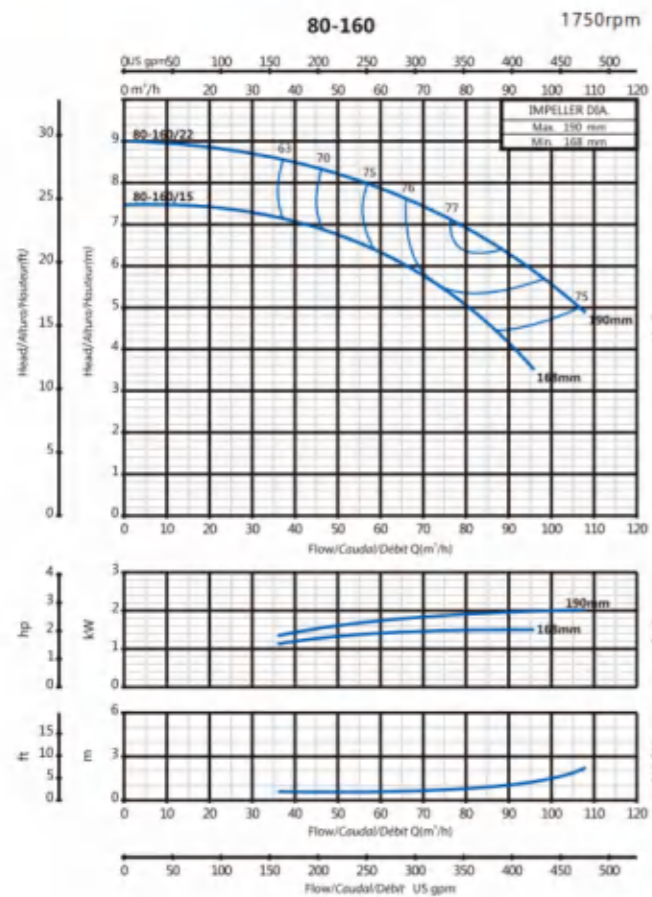

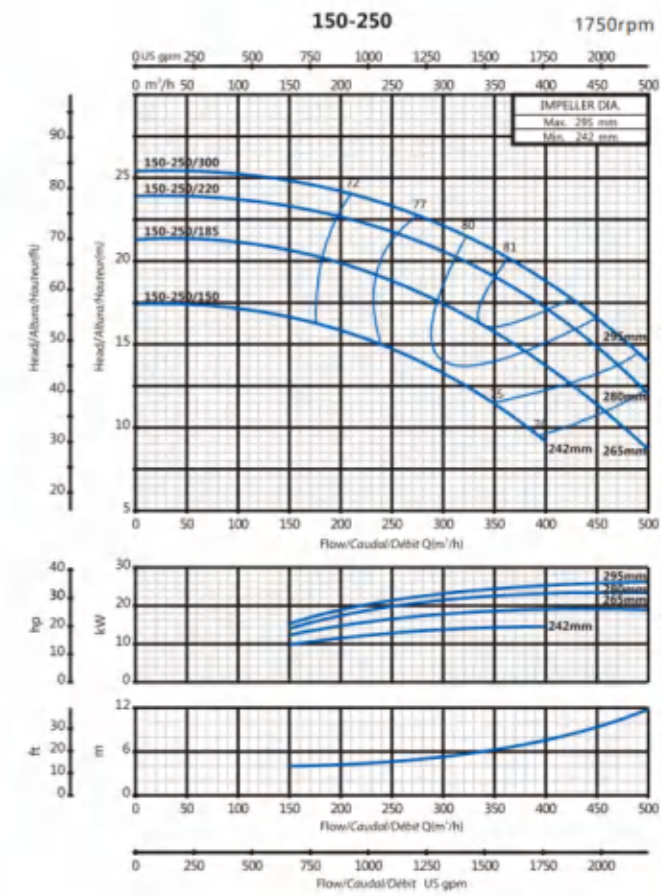
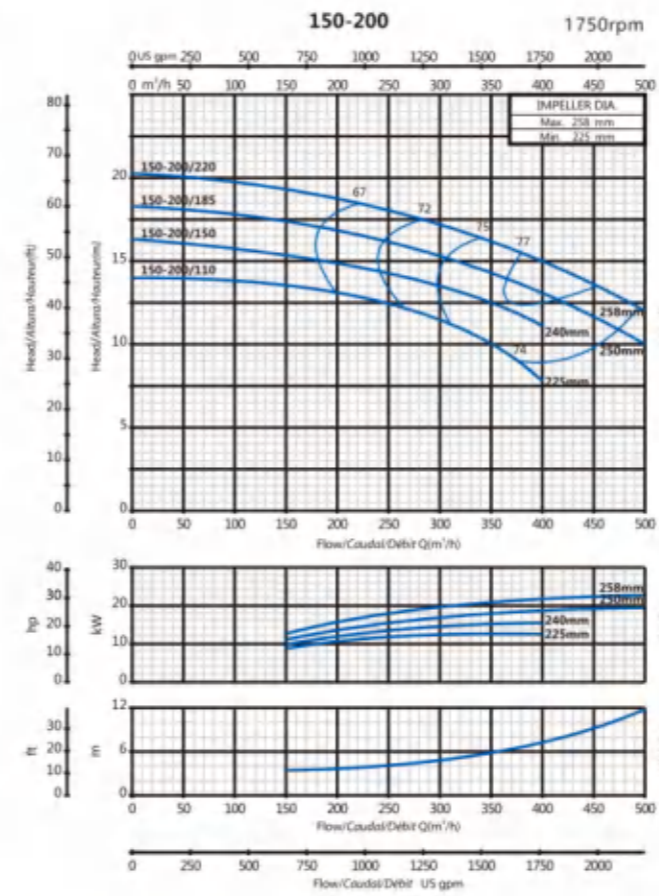
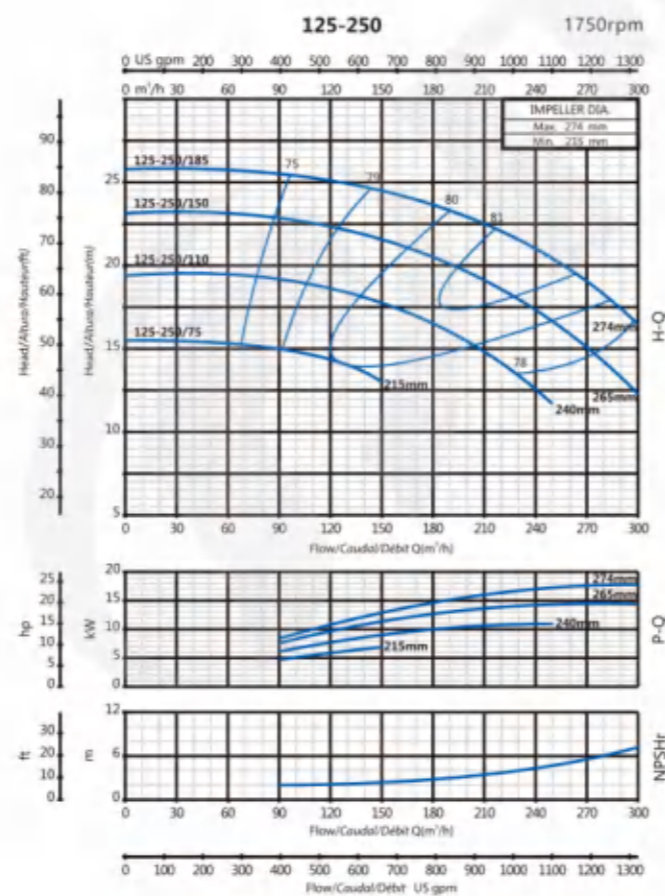
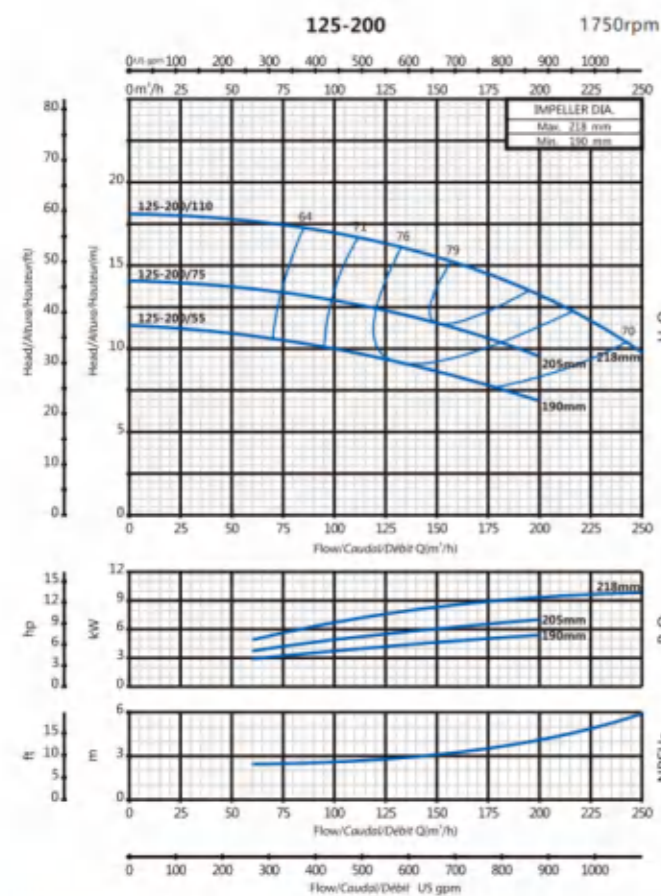
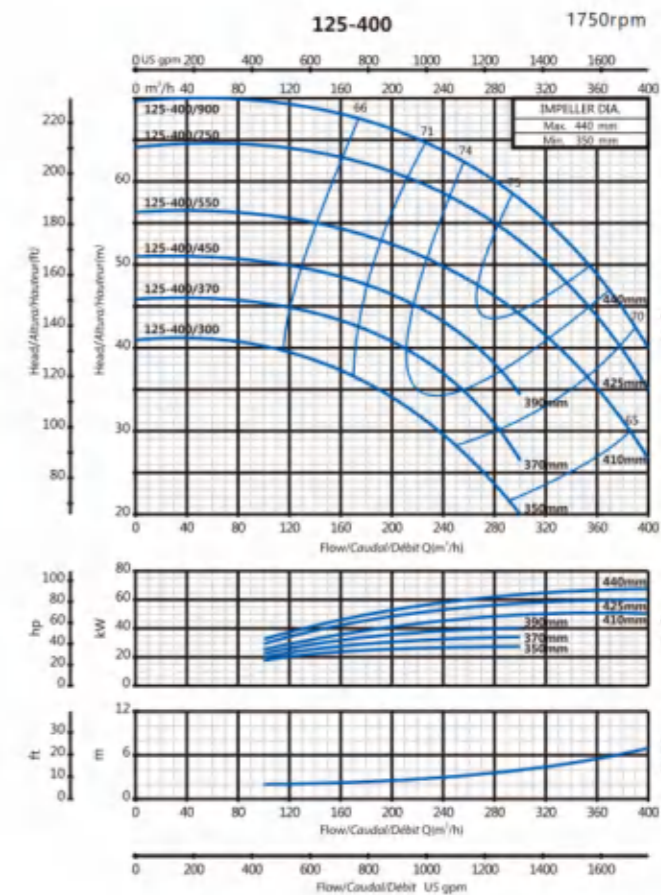
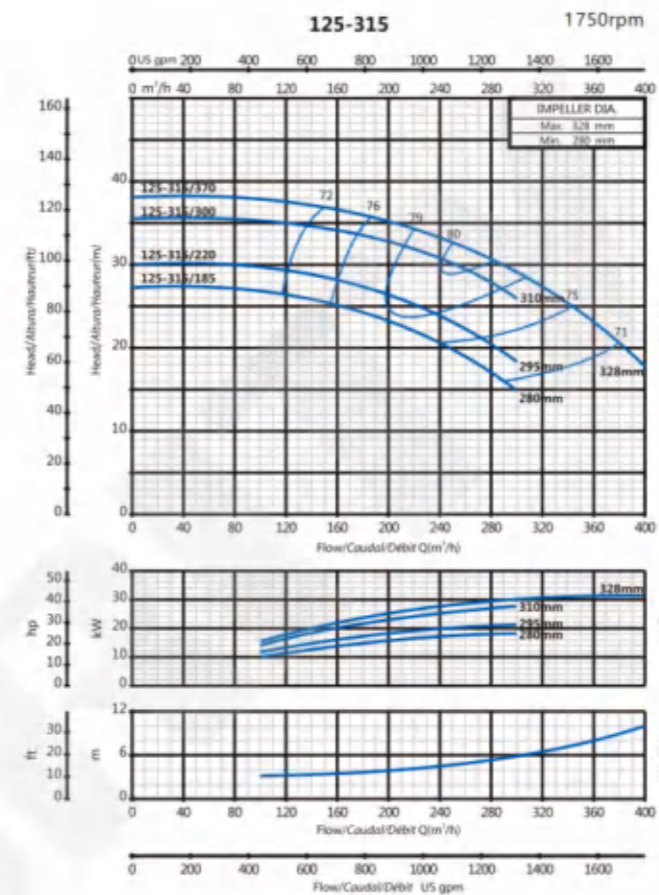
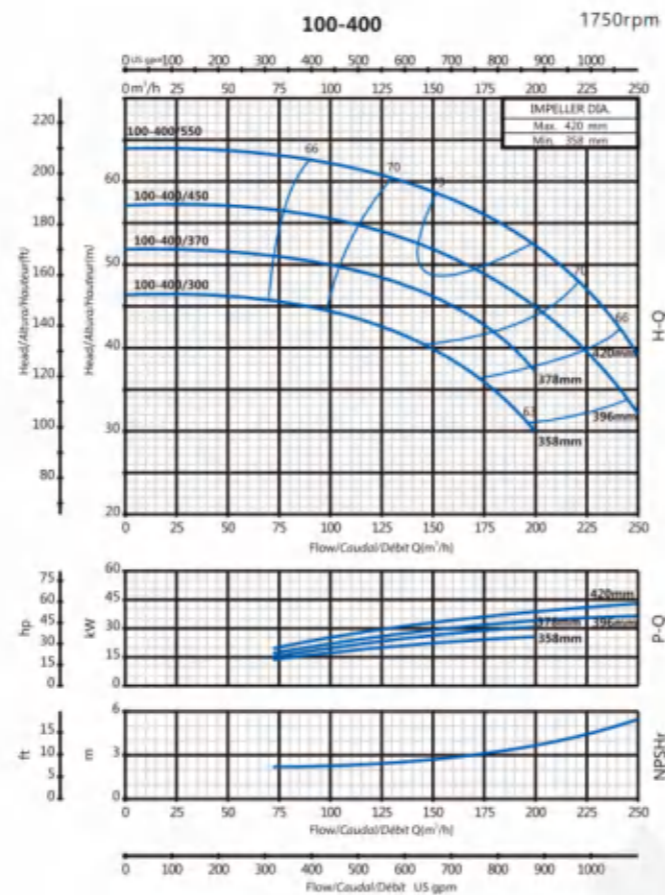
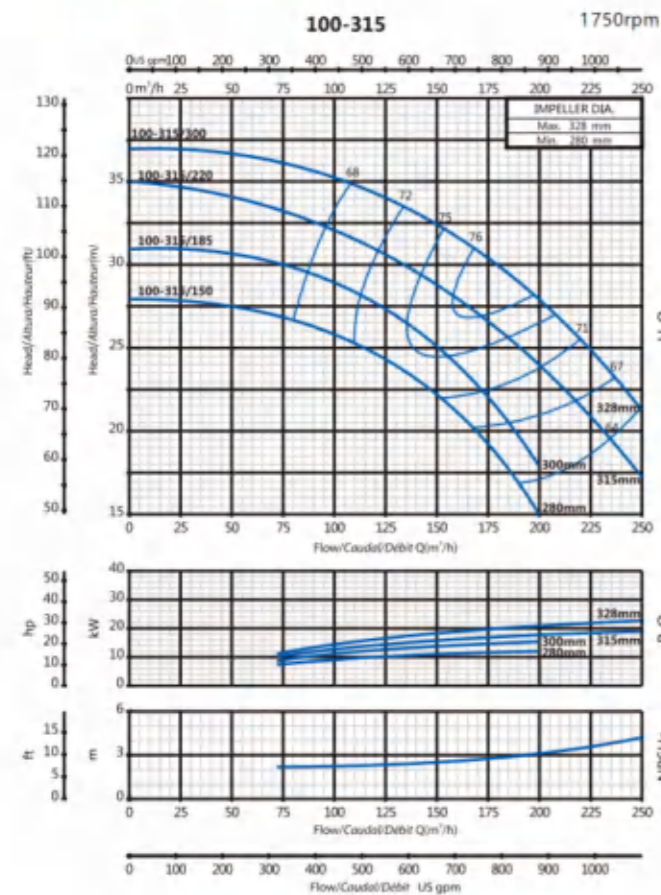

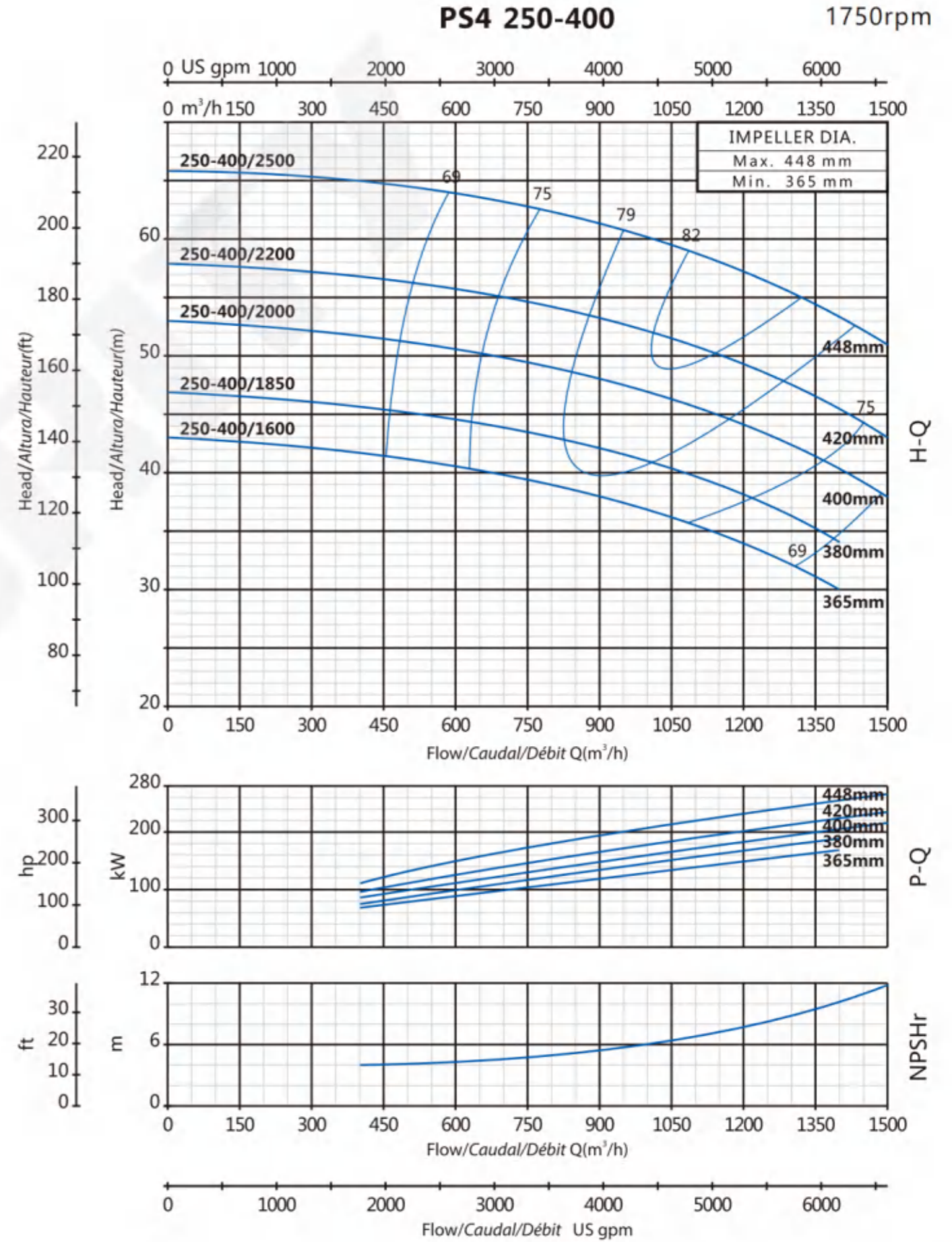
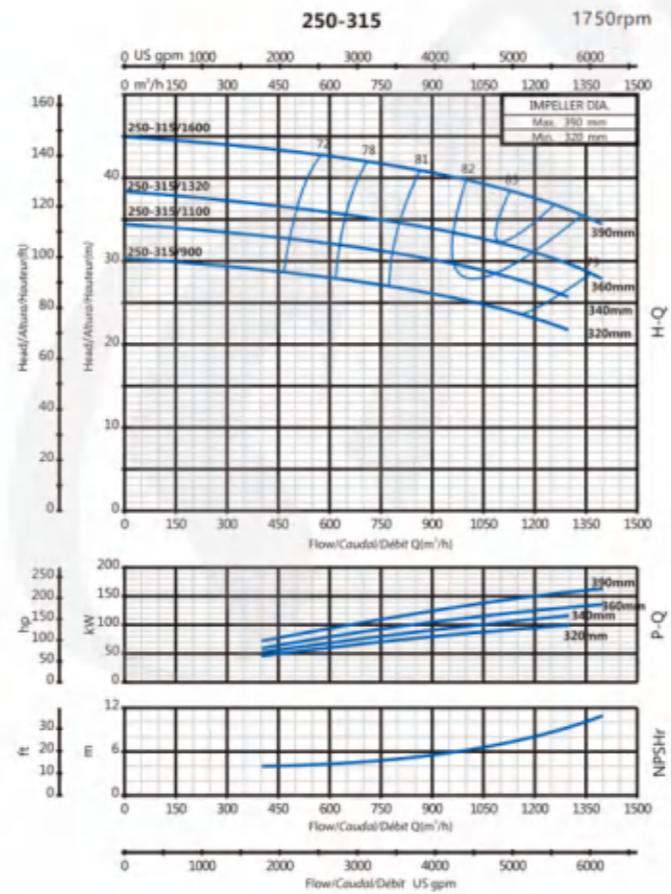
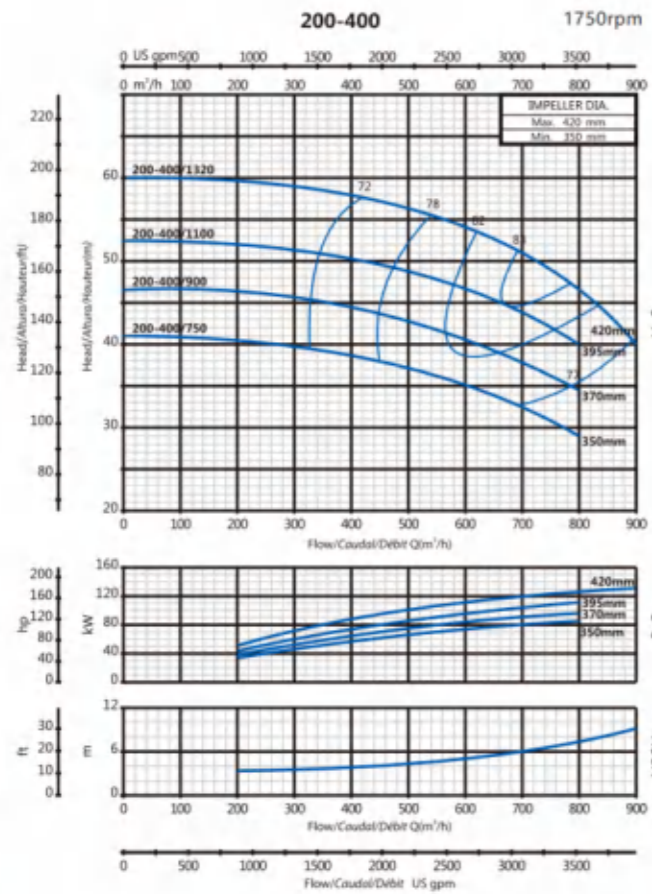
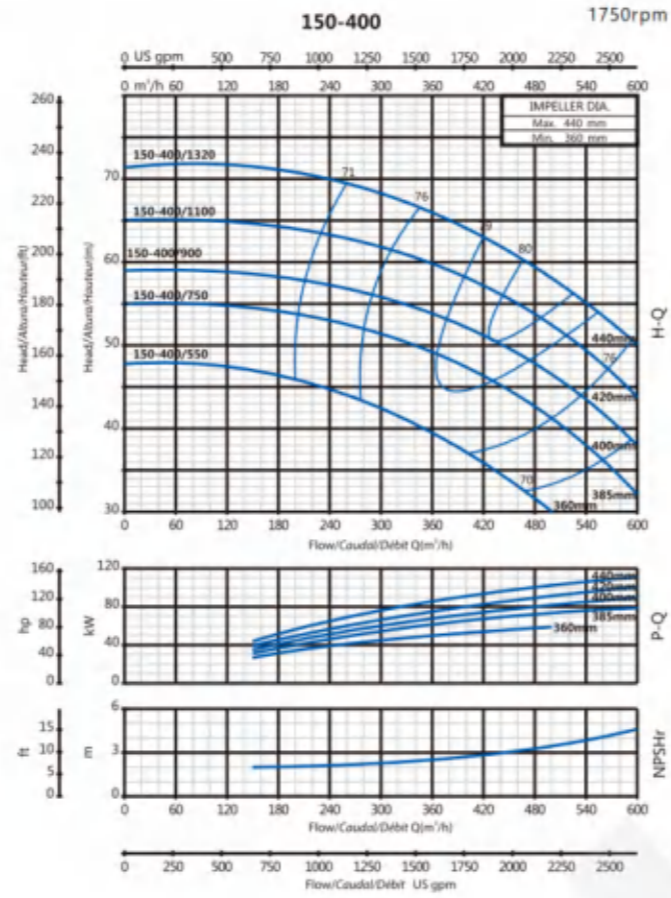
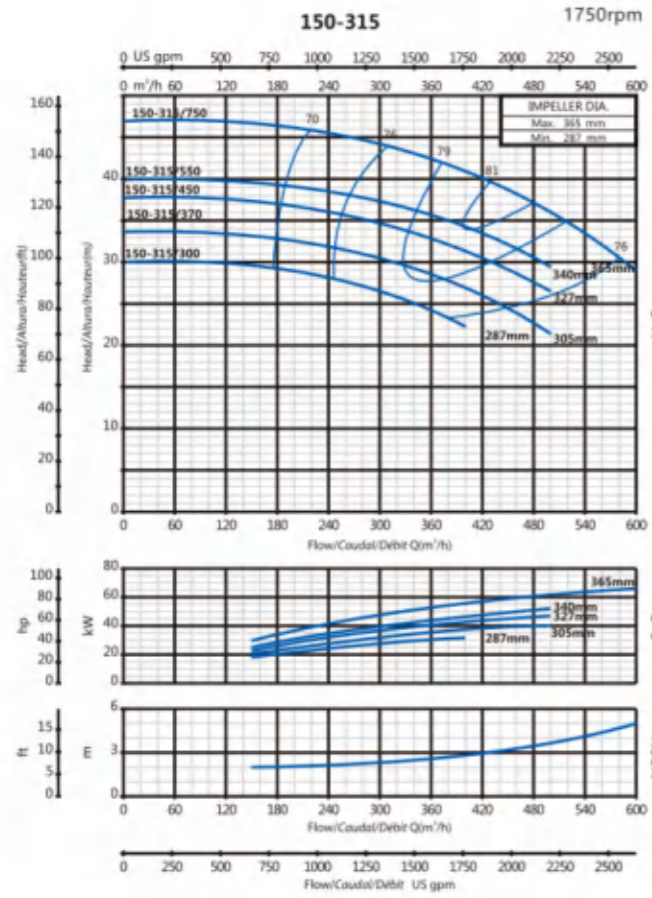

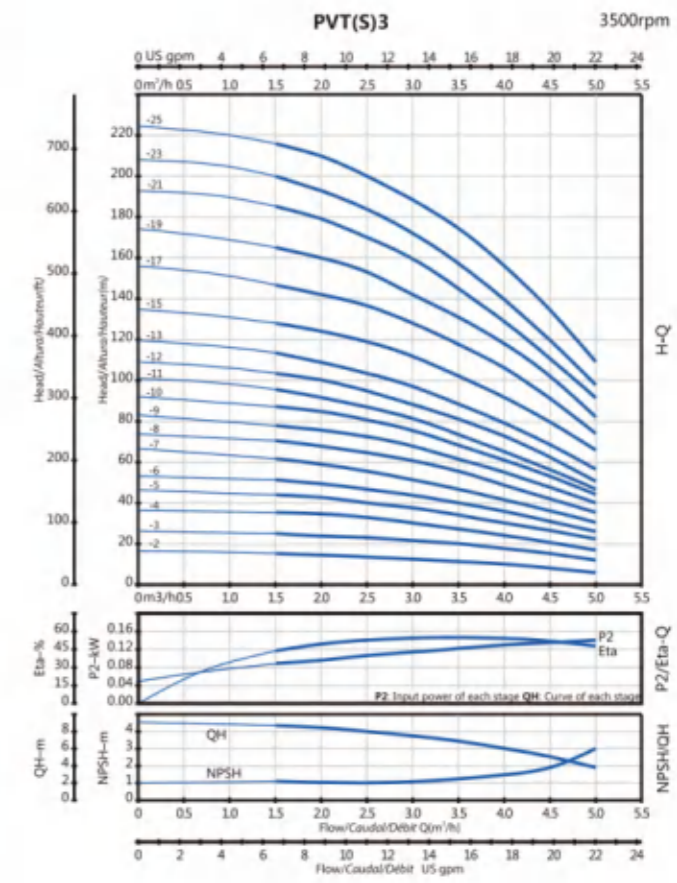
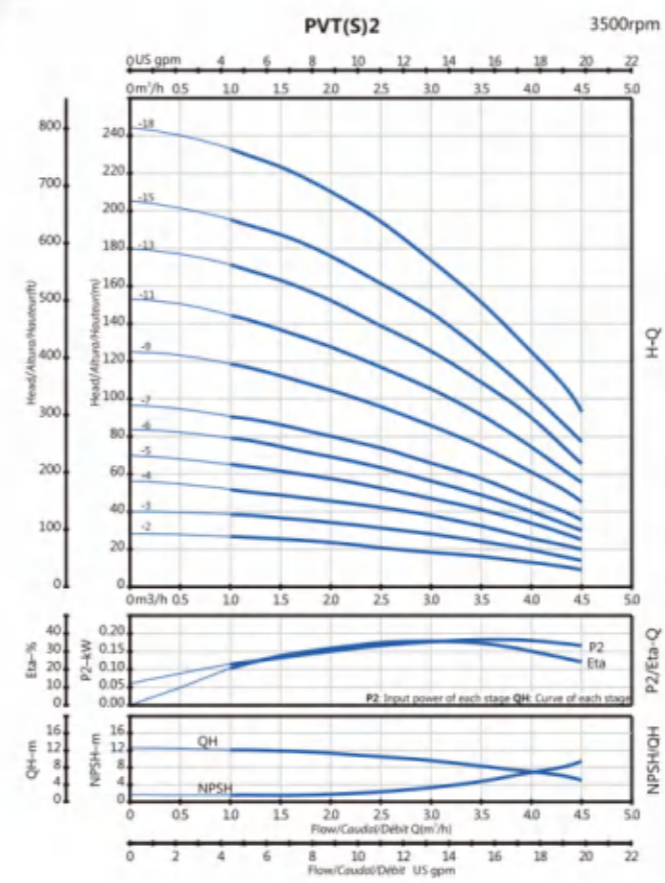
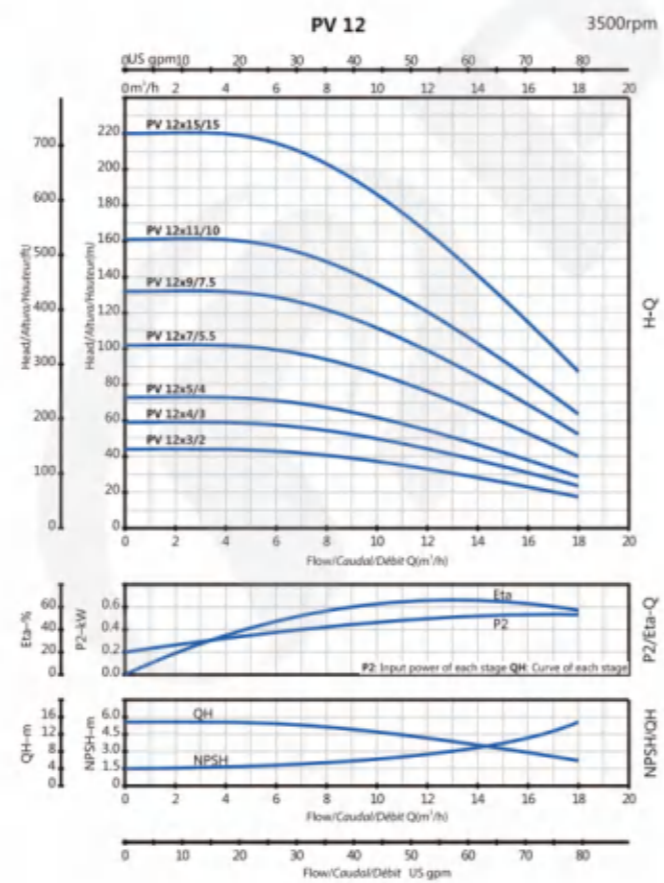
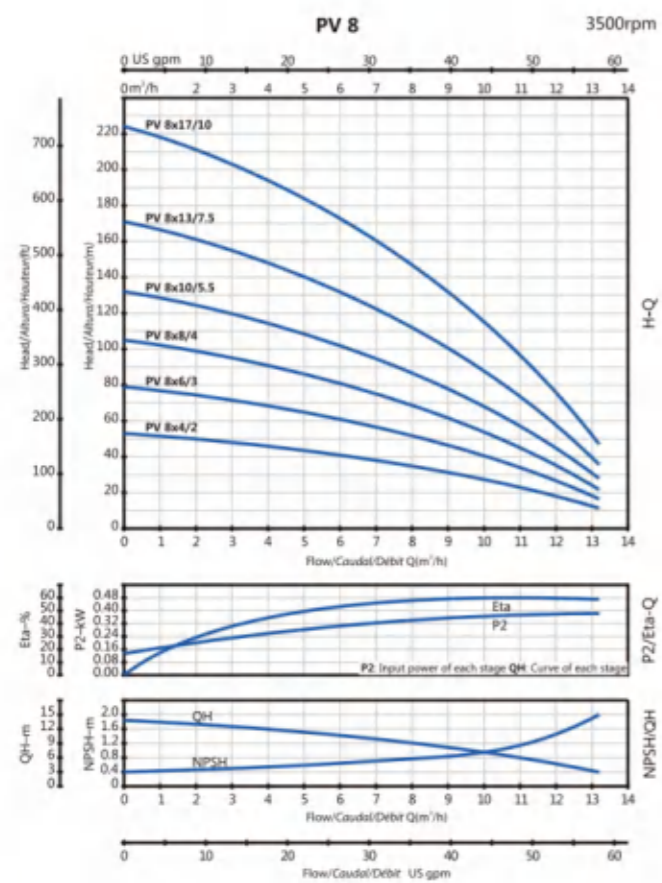
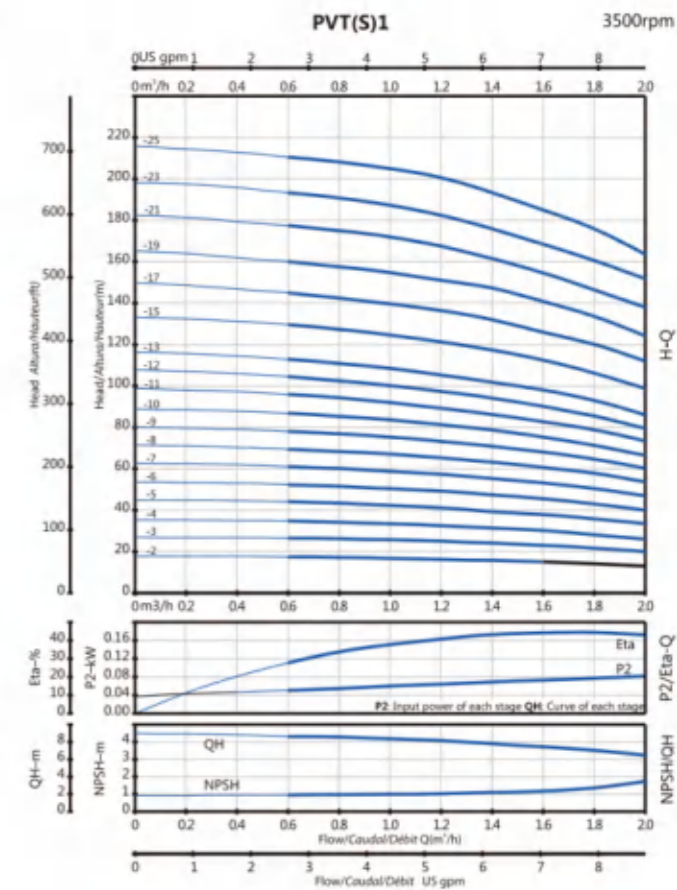
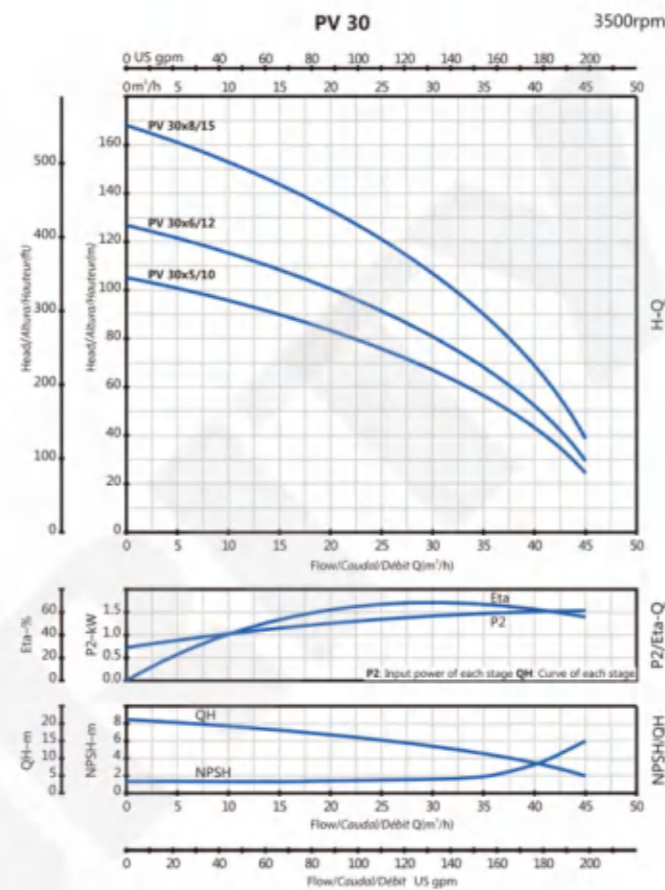
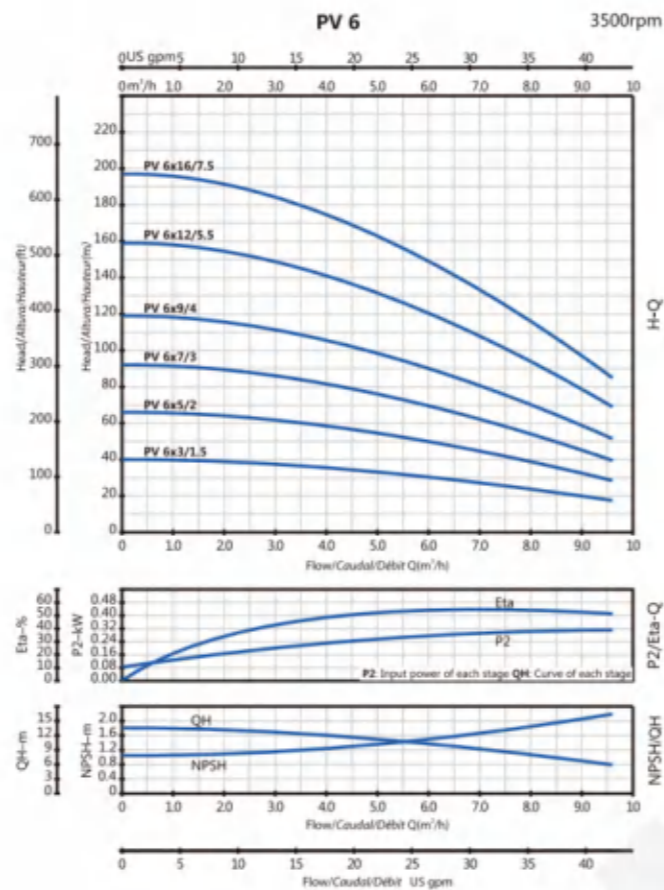
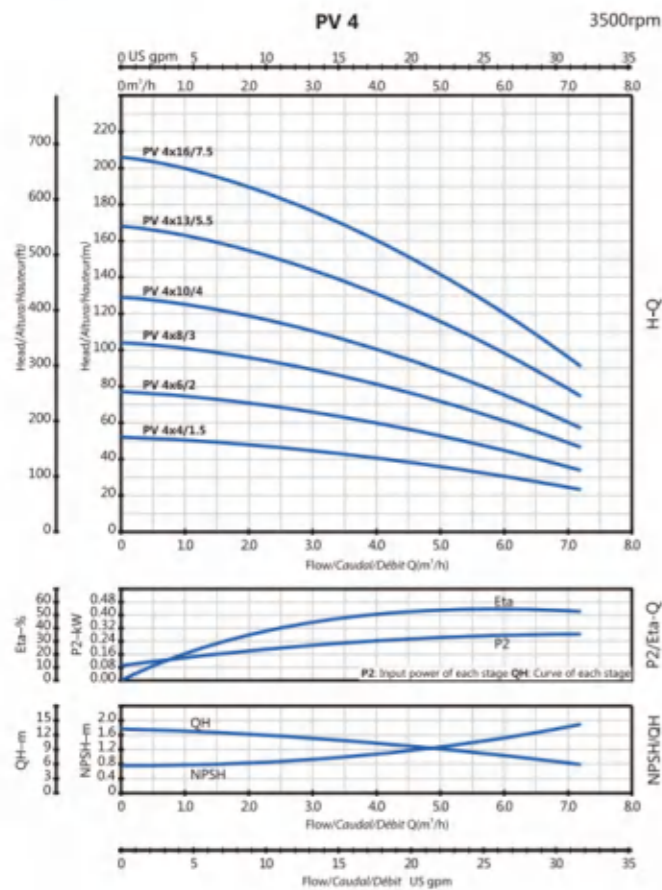



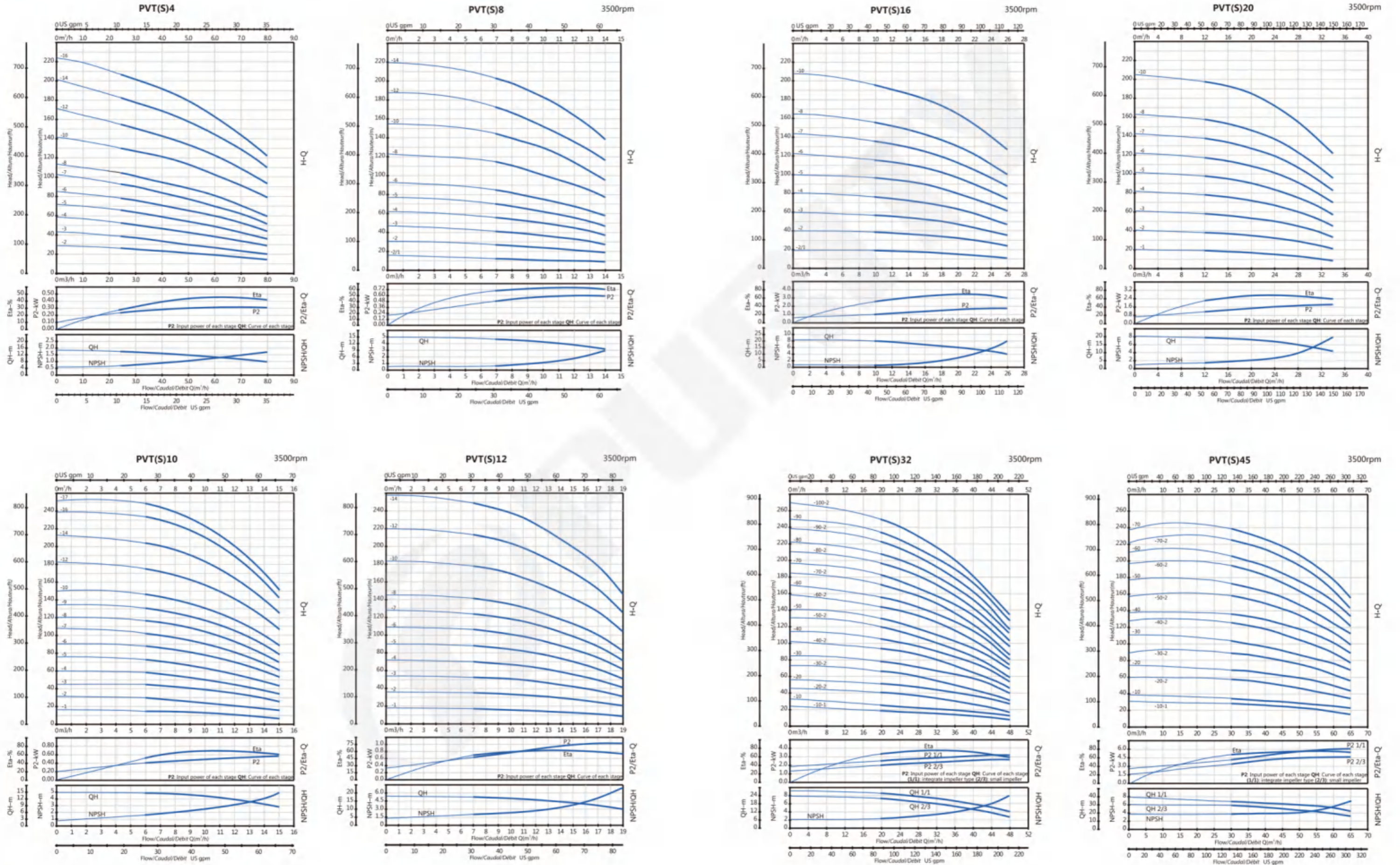

**PVT(S)64**

3500rpm

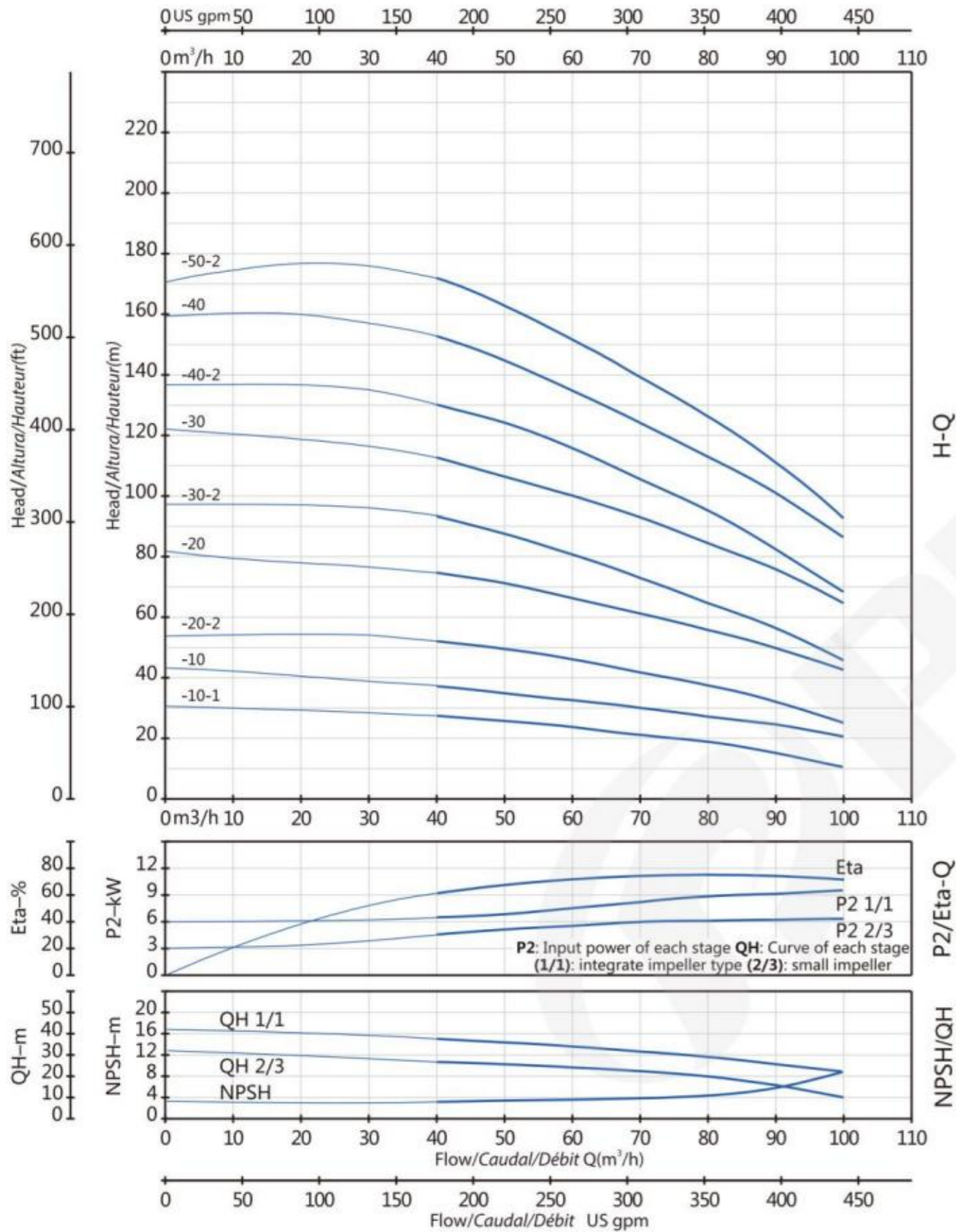
**PVT(S)90**

3500rpm

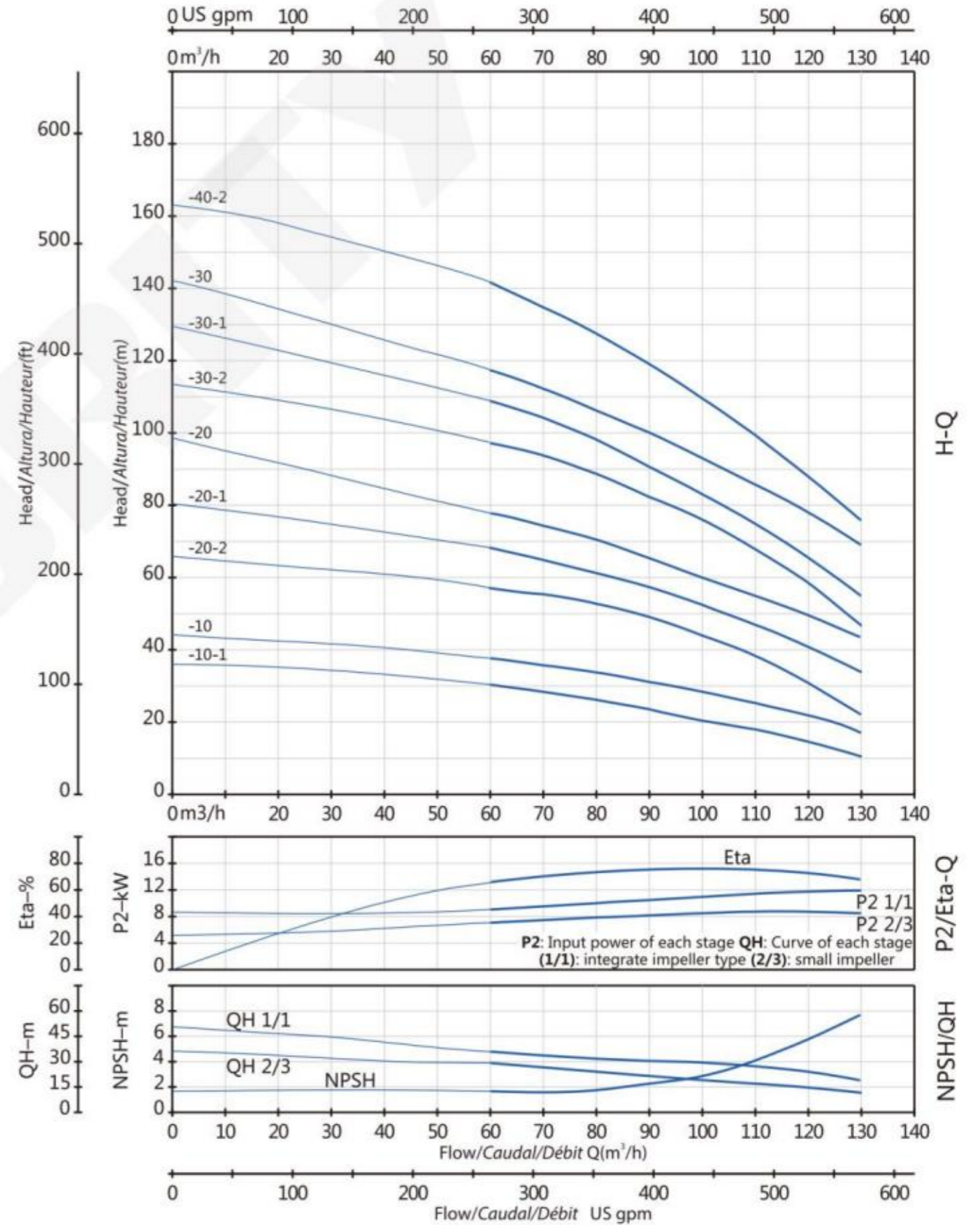



#### GENERAL SALES CONDITIONS

1) ORDERS: Any order sent to us, whether by our representatives or by letter, telephone or fax, will be considered definite only after our regular acceptance in writing. 2) DELIVERY: The terms indicated for delivery are not binding but subject to manufacturing factors and unforeseeable circumstances (trade unions unrest, breakdown of machinery, late delivery by our suppliers, general unavailability of raw materials, fire, flood or other forces majeure). Any delay which might occur will not give rise on the part of the purchaser of the right to annul the order or to claim damages. 3) TRANSPORT: Goods travel at the customer's risk even if the price is stated as carriage free. The vendor will not be liable for the underweight goods or damage caused during transit as the carrier is exclusively liable in such cases and it is to him that the receiving party must promptly address a right informative notice in writing to this to the dealer. After 8 days have passed from receipt of the goods, no claims are in any case admissible. 4) PRICES: The prices are to be understood as net of tax duties and may be changed without notice. 5) RIGHT OF PROPERTY: The goods property belongs to the manufacturer and it is not acquired by the customer until the complete payment is made for the goods, and for any interest and costs involved. In case of payment not honoured, goods will, on the manufacturer's express request, be promptly sent back to the stores in free port indicated by the manufacturer. In any case the manufacturer reserves the right to charge the customer with the cost of restoration and renewal of returned goods. 6) PAYMENTS: Payments must be effected at due dates and in the terms agreed at our Headquarters. Payments made to agents, representatives or others are not recognized even by bills unless there is an express written authority by the manufacturer. In case of payment by instalments the failure to pay even one instalment allows the manufacturer to require the balance immediately plus the interest accrued at the average rate in force for the period. 7) BLOCKAGE OF CLAIMS: The customer may not, for any reason, delay or suspend payments owed on any account even if claims or disputes have arisen, nor may he start or take legal action of any kind if he has not first paid by the terms and in the terms agreed. 8) TECHNICAL CHARACTERISTICS: The technical data and characteristics stated in all the manufacturer's official publications refer to indicative nominal values. For specific needs and on explicit demand, the manufacturer can provide detailed technical sheets from which the internal acceptance criteria of the product can be deduced. The manufacturer reserves the right to make any modification without prior notice. Therefore weights, dimensions, performances and any other stated issues are indicative only and not binding.



#### CONDICIONES GENERALES DE VENTA

1) PEDIDOS: Cualquier pedido transmitido, ya sea por medio de nuestros agentes, ya por medio de carta, teléfono o fax, se considera definitivo sólo después de nuestra regular aceptación por escrito. 2) ENTREGA: Los términos indicados para la entrega no resultan obligativos sino que están sometidos a las posibilidades de fabricación o a fuerzas mayores (movimientos sindicales, averías de las maquinarias, entrega retrasada por parte de los proveedores, condiciones generales por las que las materias primas resultan imposibles de hallar, incendios, inundaciones o otras fuerzas mayores). Un retraso eventual no puede resultar por parte del comprador en cancelación del pedido ni en pretensión de indemnización. 3) ENVÍO: La mercancía viaja por cuenta y riesgo del remitente aun si su precio está fijado franco domicilio del comprador. No se responde de algún daño debido a falta de peso o a averías de viaje ya que por eso resulta responsable solamente y exclusivamente el transportista al que el destinatario debe rápidamente elevar reserva antes de retirar la mercancía y de eso dar comunicación por escrito también al cesionario. Transcurridos 8 días de la data de recepción de la mercancía no se admiten más reclamaciones. 4) PRECIOS: Los precios se entienden libres de gravámenes fiscales y pueden variarse sin previo aviso. 5) RESERVA DE PROPIEDAD: La propiedad de los bienes entregados es del fabricante y pasa al cliente sólo después del pago integral del precio, de los intereses y de los gastos debidos. En caso de incumplimiento la mercancía será, sobre expreso pedido del fabricante, rápidamente devuelta a los depósitos del fabricante indicados puerto franco. El fabricante se reserva el derecho de adeudar al cliente los gastos soportados para la regeneración y renovación del material devuelto. 6) PAGOS: Los pagos deben efectuarse al vencimiento y según las modalidades establecidas, a nuestra sede. No se reconocen pagos efectuados a agentes, representantes o otras personas aun si por medio de efectos, salvo expresa autorización del fabricante por escrito. En caso de pago dilacionado, la falta de pago aun de una rata solamente permite al fabricante de exigir el saldo inmediato del crédito residuo añadido de los intereses devengados al tipo medio en vigor en aquel período. 7) ACCION PROHIBIDA: El cliente no puede por ninguna razón retrasar o suspender los pagos debidos a cualquier título, aun si hubieran reclamaciones o contestaciones, ni puede entablar o continuar acciones judiciales de cualquier tipo si antes no haya tomado medidas para el pago dentro de los términos y según las modalidades establecidas. 8) CARACTERÍSTICAS TÉCNICAS: Los datos y las características citadas en todas las publicaciones oficiales del fabricante, se refieren a valores nominales indicativos. Para responder a específicas necesidades y bajo explícita demanda, el fabricante dispone de fichas técnicas detalladas donde se pueden deducir los criterios de aceptación interna del producto. El fabricante se reserva el derecho de aportar cualquier modificación sin previo aviso: por lo tanto pesos, medidas, prestaciones y demás informaciones no son vinculantes sino que indicativos.



#### CONDITIONS GENERALES DE VENTE

1) COMMANDES: Toute commande, faite par l'intermédiaire de nos agents, par lettre, par téléphone ou encore par télécopie, doit être considérée définie seulement après acceptation écrite de notre part. 2) LIVRAISON: Les délais indiqués pour la livraison ne nous engagent pas, mais ils sont subordonnés aux possibilités de fabrication et aux cas de force majeure (agitations syndicales, dégâts aux machineries, livraison différée de la part des fournisseurs, situations générales d'impossibilité de trouver les matières premières, incendies, inondations, ou d'autres causes de force majeure). Un retard éventuel ne peut pas déterminer, de la part de l'acheteur, l'annulation de la commande ni la prétention d'un dédommagement. 3) EXPEDITION: Les marchandises voyagent au risque et péril du commettant même si le prix est établi franco destination. Nous ne répondons pas des réclamations dues à faute de poids ni à avaries de voyage, étant responsable de cela uniquement et exclusivement le transporteur au quelle destinataire doit promptement dresser une réserve avant de retirer la marchandise et communiquer cela par écrit, pour information, même au cessionnaire. Après 8 jours à calculer à partir de la date de réception des marchandises, aucune pas au clients sinon après paiement intégral du prix, des intérêts et des frais dûs. En cas de défaillance, la marchandise sera livrée de nouveau, sur demande précise du fabricant, aux dépôts indiqués par le fabricant franco de port. De toute façon le fabricant se réserve la faculté de débiter au client les frais supportés pour la régénération et la mise à neuf du matériel rendu. 4) PAIEMENTS: Les paiements doivent être effectués à l'échéance et selon les formes convenues dans notre siège. Les paiements faits à agents, représentants ou autres même si au moyen d'effets ne sont pas reconnus, sauf précise autorisation écrite de la part du fabricant. En cas de paiement échelonné, le non-paiement même d'un seul versement permet au fabricant d'exiger le solde immédiat du crédit restant augmenté des intérêts rapportés au taux moyen en vigueur dans cette période. 5) DEFENSE D'ACTION: Le client ne peut, pour aucune raison, différer ni suspendre les paiements dus à réclamation n'est acceptée. 6) PRIX: les prix s'entendent nets des charges fiscales et peuvent être variés sans que le fabricant soit obligée de donner un préavis. 7) RESERVE DE PROPRIETE: La propriété des biens livrés reste au fabricant et ne passe n'importe quel titre, même si des réclamations ou des contestations ont surgi. En outre, il ne peut ni tenter ni poursuivre aucune action en justice de n'importe quel genre, si, avant cela, il n'a pas pourvu au paiement dans les termes et les formes convenus. 8) CARACTERISTIQUES TECHNIQUES: Les données et les caractéristiques techniques citées dans toutes les publications officielles du fabricant se rapportent à des valeurs nominales indicatives. Sur demande et pour des nécessités spécifiques, le fabricant peut mettre à disposition des fiches techniques des produits détaillées par lesquelles on peut déduire aussi les critères de recevabilité technique interne des produits. Le fabricant se réserve le droit d'apporter n'importe quelle modification sans aucun préavis; par conséquent les poids, les mesures les performances et tout ce qui est indiqué ne sont pas contraignants mais simplement indicatifs.

Reliable Pumps For Project